 +92-302-0616808

 [info@scissors-way.com](mailto:info@scissors-way.com)  
[www.scissors-way.com](http://www.scissors-way.com)

 Haji Pura, Daska Road, Sialkot. Punjab 51310 - Pakistan



## TABLE OF CONTENTS

Dressing & Tissue Forceps	1-3
Scissors	33-98
Needle Holders	99-134
Hemostatic Forceps	135-152
Intestinal Forceps	153-163
Hand Retractors	165-199
Self Retaining Retractors	200-219
Hooks	221-233
Knife Handles	235-238
Dermatology Surgery Instruments	239-240
Forceps Holder	241-242
Rectal Surgery Instruments	243-252
Towel Clips	253-255
Sponge Holding Forceps	256-261
Catheter Introducing Forceps	262
Trocars	263-264
Suction Tubes	264-265
Mouth Gags	267-270
Vein Strippers	271
Probes	272-273
Maxilo-Facial Surgery Instruments	275-282
Trachea Tubes	283
Urology Surgery Instruments	285-295
Orthopedic Surgery Instruments	297-372
Neurology Surgery Instruments	373-417
Chest Surgery Instruments	419-425
Ophthalmology Surgery Instruments	427-433



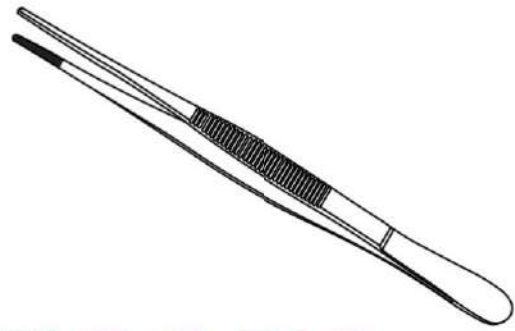

# Forceps

- Forceps
- Micro Forceps
- Forceps **TC**

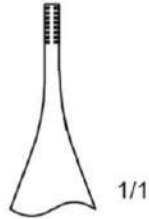

▶ 01-0701 12.0 cm  
01-0712 15.0 cm

**ADSON-BROWN**  
9X9 teeth

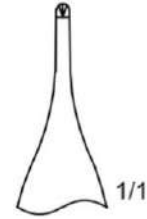

01-0703 12.0 cm

**HUDSON**  
1X2 teeth Extra long tip



01-0801 12.0 cm

**ADSON-BIEMER**  
Forward teeth

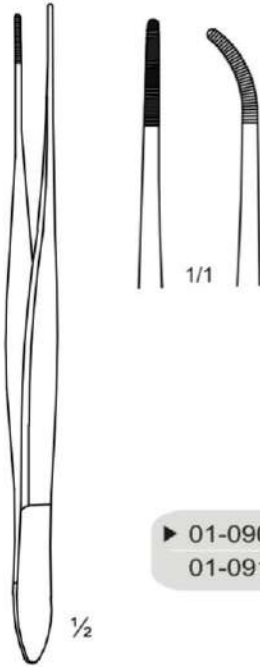

▶ 01-0901	18.0 cm	Straight
▶ 01-0911	18.0 cm	Curved

**CUSHING**  
with dissector end

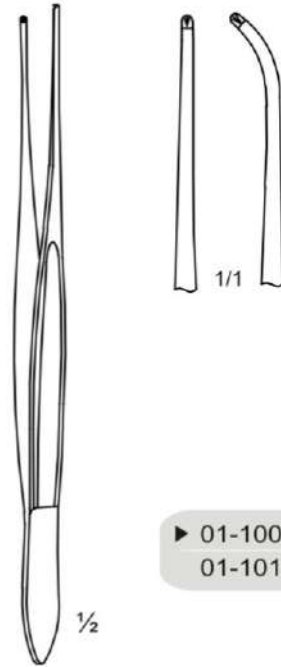

▶ 01-1001		
▶ 01-1011		

**CUSHING**  
with dissector end  
1X2 teeth

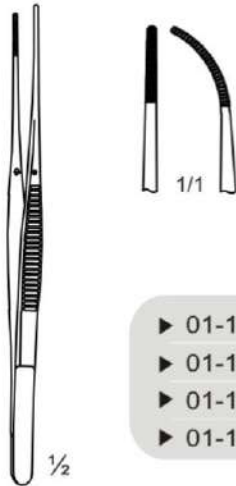

▶ 01-1101	12.5 cm	Straight
▶ 01-1102	15.5 cm	Straight
▶ 01-1111	12.5 cm	Curved
▶ 01-1112	15.5 cm	Curved

**SEMKEN**

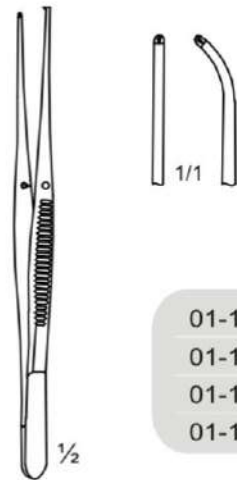

▶ 01-1201		
▶ 01-1202		
▶ 01-1211		
▶ 01-1212		

**SEMKEN**  
1X2 teeth

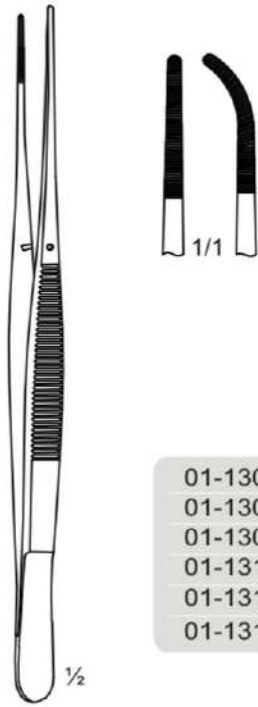

01-1301	18.0 cm	Straight
01-1302	21.0 cm	Straight
01-1303	25.0 cm	Straight
01-1311	18.0 cm	Curved
01-1312	21.0 cm	Curved
01-1313	25.0 cm	Curved

POTTS-SMITH

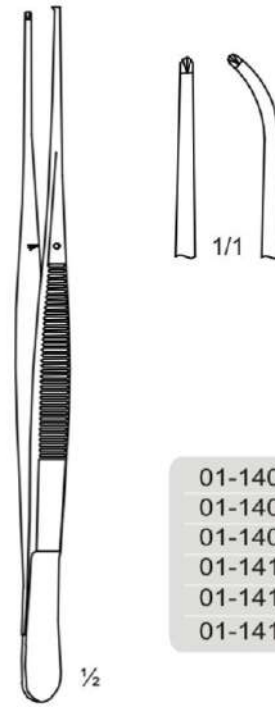

01-1401	18.0 cm	Straight
01-1402	21.0 cm	Straight
01-1403	25.0 cm	Straight
01-1411	18.0 cm	Curved
01-1412	21.0 cm	Curved
01-1413	25.0 cm	Curved

POTTS-SMITH  
1X2 teeth

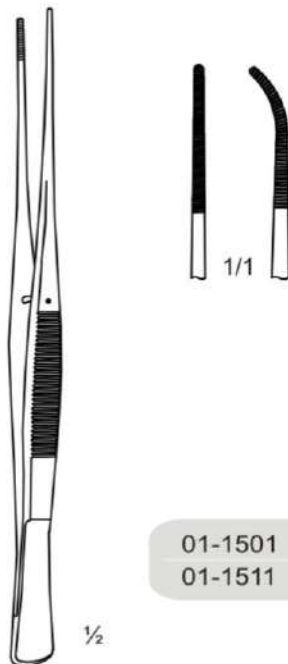

01-1501	17.5 cm	Straight
01-1511	17.5 cm	Curved

TAYLOR

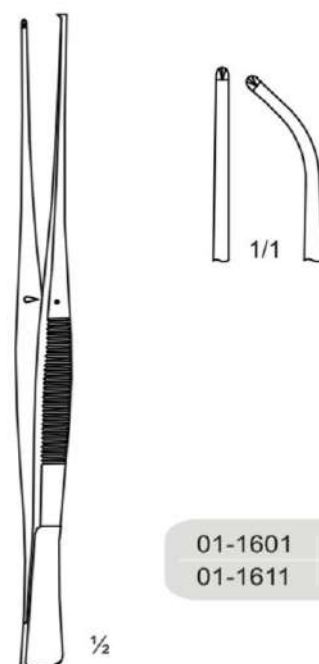

01-1601	17.5 cm	Straight
01-1611	17.5 cm	Curved

TAYLOR  
1X2 teeth



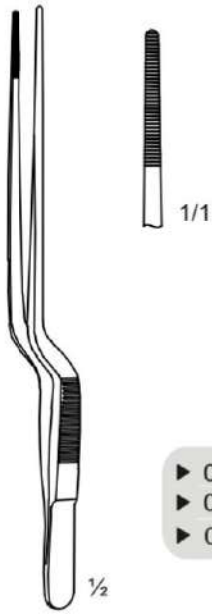

- ▶ 01-1701 14.0 cm
- ▶ 01-1702 16.0 cm
- ▶ 01-1703 19.0 cm

**JANSEN**

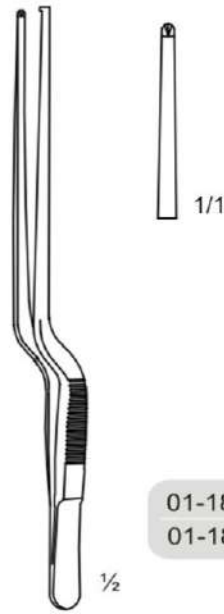

- 01-1801
- 01-1802

**JANSEN**  
1X2 teeth

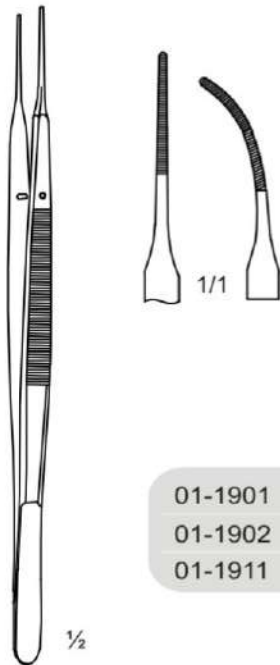

- 01-1901 18.0 cm Straight
- 01-1902 18.0 cm Bayonet Type
- 01-1911 18.0 cm Curved

**GERALD**

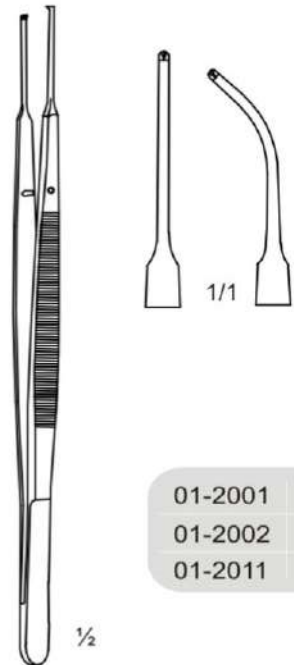

- 01-2001
- 01-2002
- 01-2011

**GERALD**  
1X2 teeth



01-2201	11.0 cm
▶ 01-2202	13.0 cm
01-2203	15.0 cm
01-2204	17.0 cm

**TROELTSCH**

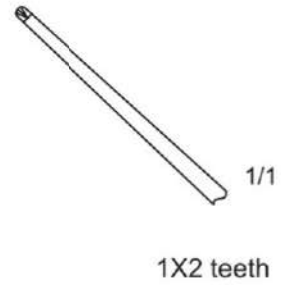

01-2301	13.0 cm
---------	---------

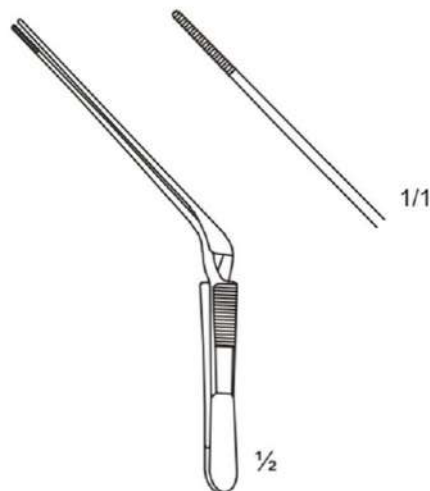

01-2401	13.0 cm
---------	---------

**TROELRSCH (WIDE)**  
Cross Action

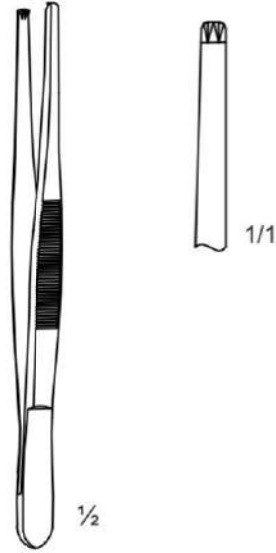

- 01-2501
- 01-2502
- ▶ 01-2503
- 01-2504
- 01-2505
- ▶ 01-2506

**TISSUE FORCEPS**  
2X3 teeth

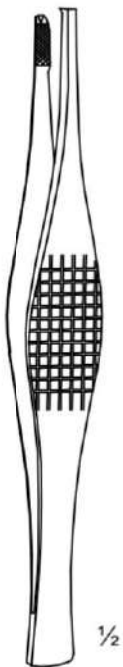

**FERRIS-SMITH**



1X2 teeth

01-2601 18.0 cm



2X3 teeth

01-2602 18.0 cm

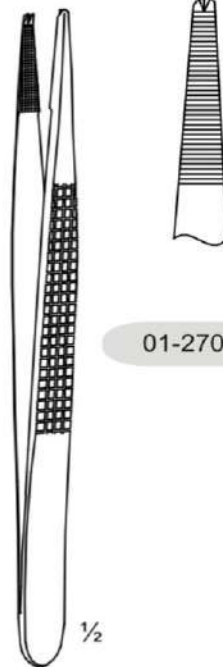

**BONNEY**  
1X2 teeth

01-2701

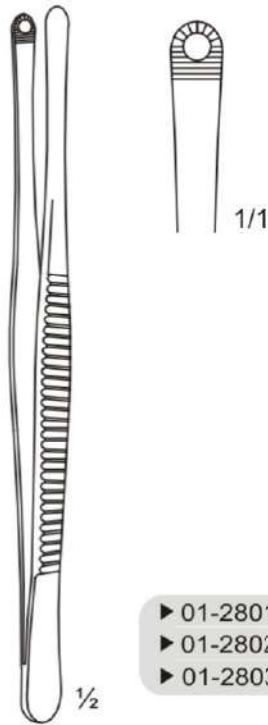

- ▶ 01-2801 15.0 cm
- ▶ 01-2802 20.0 cm
- ▶ 01-2803 25.0 cm

**RUSSIAN**  
Vascular and Tumor Forceps

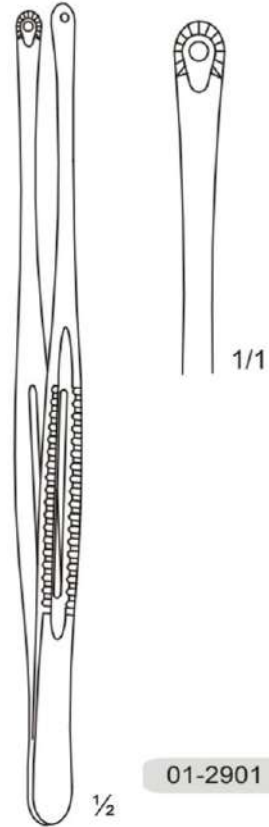

- 01-2901 23.0 cm

**MAYO-RUSSIAN**  
Vascular and Tumor Forceps

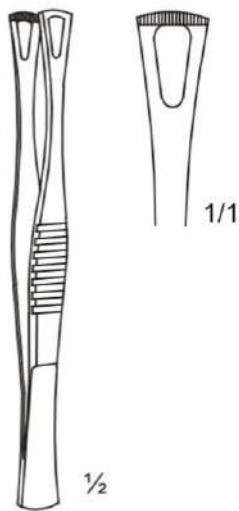

- 01-3001 14.0 cm

**DUVAL**  
Intestinal Forceps

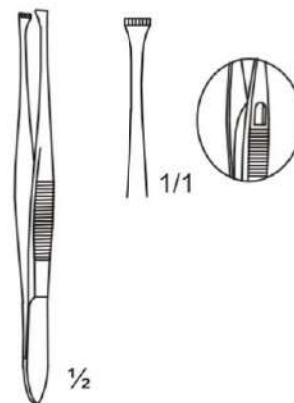

**GRAEFE**

- 01-3101 11.0 cm with catch
- ▶ 01-3102 11.0 cm without catch





Ⓒ

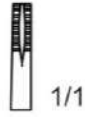
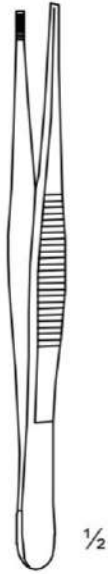

1/1

1/2

- ▶ 01-3201 15.0 cm
- ▶ 01-3202 20.0 cm
- ▶ 01-3203 25.0 cm

**BROWN**  
Tissue Seizing Forceps



1/1

1/2

**HUNTER**

- 01-3301 10.5
- 01-3302 10.5

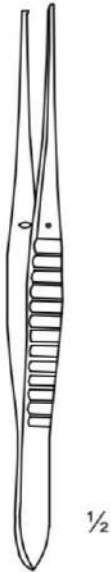

1/1

1/2

**GILLIES**  
1 x 2 teeth

- 01-3401 15.0 cm



1/1

1/2

**MC INDOE**

- 01-3402 15.0 cm

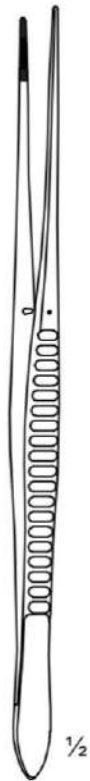

01-3501	18.0 cm
01-3502	21.0 cm

**WAUGH**



01-3511	18.0 cm
01-3512	21.0 cm

**WAUGH**  
1X2 teeth



**IRIS**

▶ 01-3601	10.5 cm	Straight
▶ 01-3611	10.5 cm	Slightly Curved
▶ 01-3612	10.5 cm	Strongly Curved

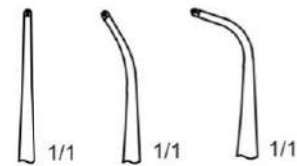

**IRIS**  
1X2 teeth

▶ 01-3701	10.5 cm	Straight
▶ 01-3711	10.5 cm	Slightly Curved
▶ 01-3712	10.5 cm	Strongly Curved

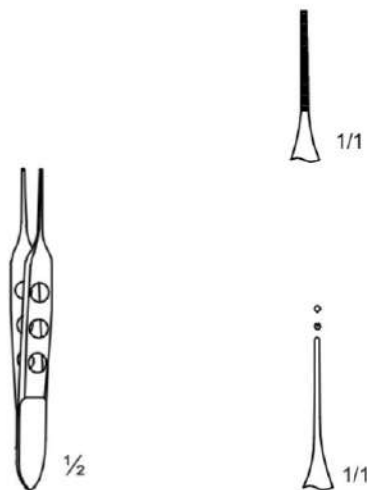

- ▶ 01-3801 8.5 cm
- ▶ 01-3802 8.5 cm Fine Tip

- ▶ 01-3901 8.5 cm
- ▶ 01-3902 8.5 cm Fine Tip

**BISHOP-HARMON**

**1X2 teeth**



**GILL**



**1X2 teeth**

- ▶ 01-4001 7.0 cm
- ▶ 01-4002 7.0 cm Extra Delicate

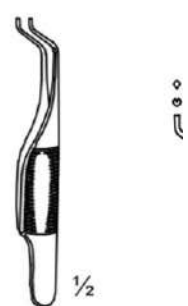

**GILL-HESS**

- ▶ 01-4004 7.5 cm



**GILL-CHANDLER**

- ▶ 01-4003 7.0 cm



**VON GRAEFE**

01-4101	7.0 cm	0.5 mm	Straight
▶ 01-4102	7.0 cm	0.7 mm	Straight
01-4103	7.0 cm	1.0 mm	Straight
01-4111	7.0 cm	0.5 mm	Curved
▶ 01-4112	7.0 cm	0.7 mm	Curved
01-4113	7.0 cm	1.0 mm	Curved

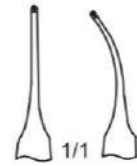

**VON GRAEFE**  
1X2 teeth

01-4201	7.0 cm	0.5 mm	Straight
▶ 01-4202	7.0 cm	0.7 mm	Straight
01-4203	7.0 cm	1.0 mm	Straight
01-4211	7.0 cm	0.5 mm	Curved
▶ 01-4212	7.0 cm	0.7 mm	Curved
01-4213	7.0 cm	1.0 mm	Curved

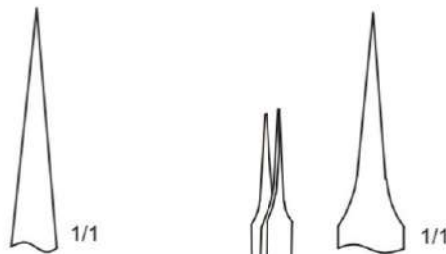
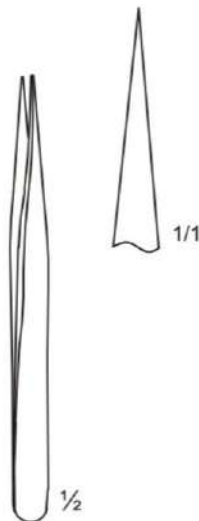

**JEWELER'S TYPE**  
Fine points

▶ 01-4303 11.5 cm

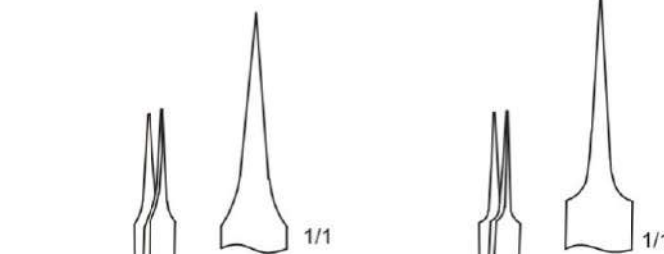
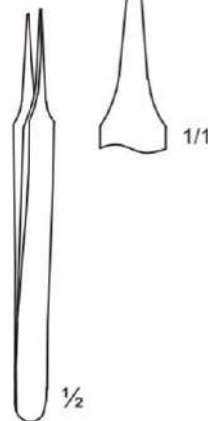

**JEWELER'S TYPE**  
Extra Fine points

▶ 01-4304 11.0 cm

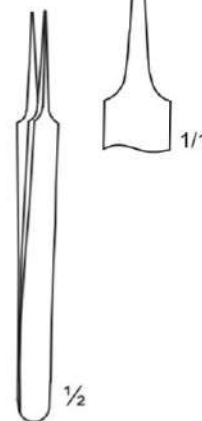

**JEWELER'S TYPE**  
Super Fine points

▶ 01-4305 11.0 cm

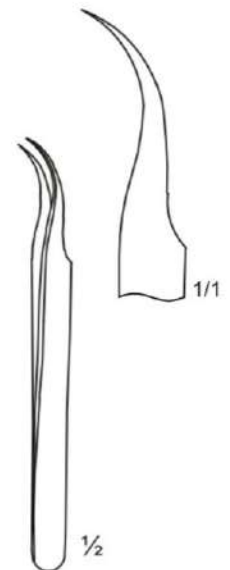

**JEWELER'S TYPE**  
Fine points

▶ 01-4306 11.5 cm



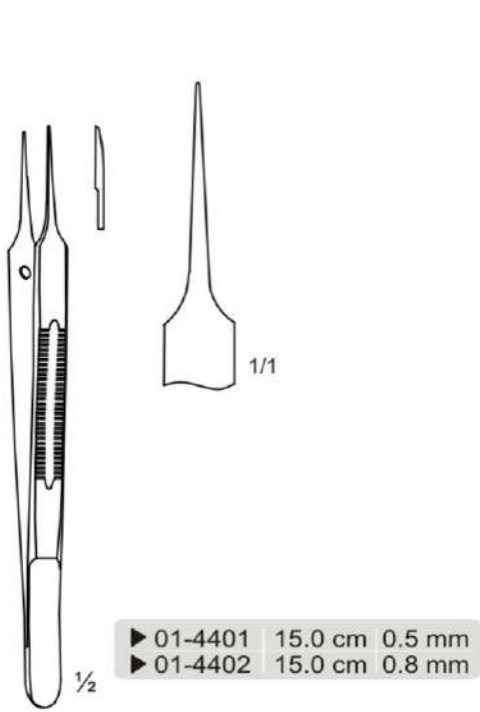

- ▶ 01-4401 15.0 cm 0.5 mm
- ▶ 01-4402 15.0 cm 0.8 mm

LAZAR

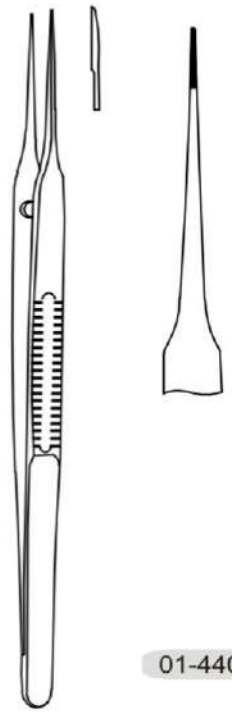

01-440

LAZAR



RHOTON

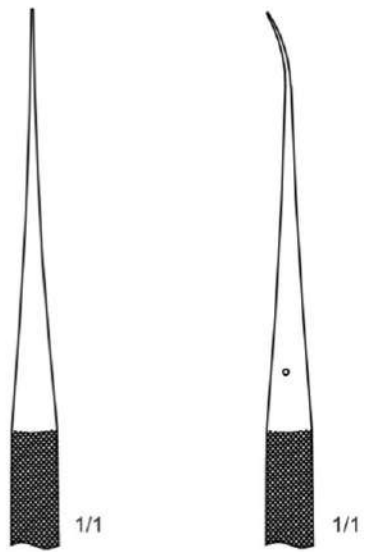

- ▶ 01-4501 18.0 cm Straight
- ▶ 01-4502 18.0 cm Curved



01-4601 12.0 cm  
01-4602 13.5 cm



01-4612 13.5 cm

**WISE**  
with smooth tying platforms

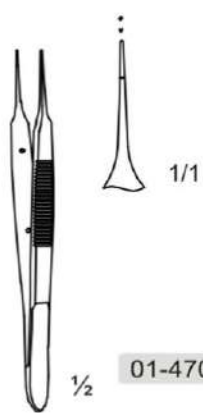

01-4701 9.5 cm

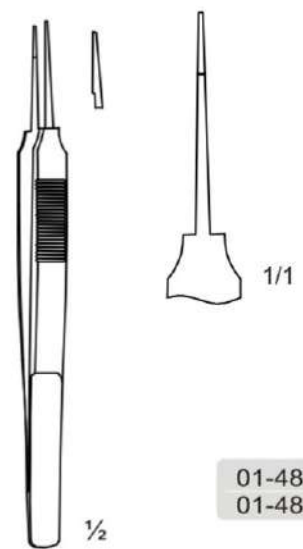

01-4801 14.0 cm  
01-4802 18.0 cm

**MICRO SUTURE TYING**

**AUSTIN**  
with smooth tying platforms

**Micro Suture Tying Forceps**



**MICRO SUTURE TYING**



Tips 0.3mm

02-0101	12.0 cm
02-0102	15.0 cm



Tips 0.6mm

02-0103	18.0 cm
02-0104	23.0 cm



**MICRO SUTURE TYING  
TITANIUM**



Tips 0.4mm

02-0101T	15.0 cm
02-0102T	18.0 cm
02-0103T	21.0 cm



Tips 0.8mm

02-0201T	15.0 cm
02-0202T	18.0 cm
02-0203T	21.0 cm





**DE BAKEY  
TITANIUM**



- 02-0301T 15.0 cm
- 02-0302T 18.0 cm
- 02-0303T 21.0 cm



- 02-0311T 15.0 cm
- 02-0312T 18.0 cm
- 02-0313T 21.0 cm



- 02-0401T 15.0 cm
- 02-0402T 18.0 cm
- 02-0403T 21.0 cm



- 02-0411T 15.0 cm
- 02-0412T 18.0 cm
- 02-0413T 21.0 cm



**MICRO-RING  
TITANIUM**



ø 1mm  
Ring Serrated

- 02-0501T 15.0 cm
- 02-0502T 18.0 cm
- 02-0503T 21.0 cm



ø 1mm  
Ring Diamond dust coated

- 02-0511T 15.0 cm
- 02-0512T 18.0 cm
- 02-0513T 21.0 cm



ø 2mm  
Ring Serrated

- 02-0601T 15.0 cm
- 02-0602T 18.0 cm
- 02-0603T 21.0 cm



ø 2mm  
Ring Diamond dust coated

- 02-0611T 15.0 cm
- 02-0612T 18.0 cm
- 02-0613T 21.0 cm



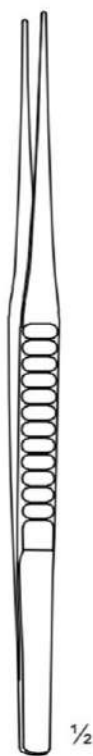

- 02-0701 1
- 02-0702 2
- 02-0703 2



- 02-0801 1
- 02-0802 2
- 02-0803 2



- 02-0901 1
- 02-0902 2
- 02-0903 2

**MICRO FORCEPS**

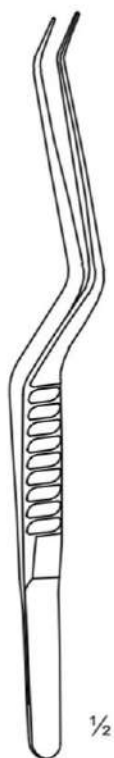

- 02-0711 1
- 02-0712 2
- 02-0713 2



- 02-0811 1
- 02-0812 2
- 02-0813 2



- 02-0911 1
- 02-0912 2
- 02-0913 2

**MICRO FORCEPS**



1/2

**YASARGIL**



1/1

02-1001	16.0 cm
02-1002	18.0 cm
02-1003	20.0 cm
02-1004	22.0 cm
02-1005	24.0 cm



1/1

02-1101	16.0 cm
02-1102	18.0 cm
02-1103	20.0 cm
02-1104	22.0 cm
02-1105	24.0 cm



1/1

02-1012	18.0 cm
---------	---------



1/2

**YASARGIL**

Jaws spoon-shaped

⊙ ∅ 3mm

⊙ ∅ 5mm

⊙ ∅ 7mm

**YASARGIL**  
**YASARGIL-SAMII**

02-1201	02-1202	
02-1301	02-1302	02-1303

● ∅ 3mm

**YASARGIL**

Flat jaws, serrated

02-1211	22.0 cm
---------	---------

● ∅ 5mm

**YASARGIL**

Flat jaws, serrated

02-1212	22.0 cm
---------	---------

⊙ ∅ 3mm

**HEIFETZ**

Curette jaws, toothed

02-1221	22.0 cm
---------	---------

⊙ ∅ 5mm

**HEIFETZ**

Curette jaws, toothed

02-1222	22.0 cm
---------	---------

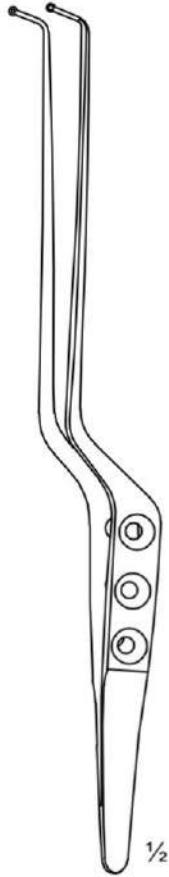

**SAMII**  
Jaws spoon-shaped



Ø 3mm  
Jaws spoon-shaped  
02-1401 23.0 cm



Ø 3mm  
Jaws spoon-shaped  
02-1411 23.0 cm



Ø 4mm  
Jaws spoon-shaped  
02-1402 23.0 cm



Ø 4mm  
Jaws spoon-shaped  
02-1412 23.0 cm



Ø 5mm  
Jaws spoon-shaped  
02-1403 23.0 cm



Ø 5mm  
Jaws spoon-shaped  
02-1413 23.0 cm

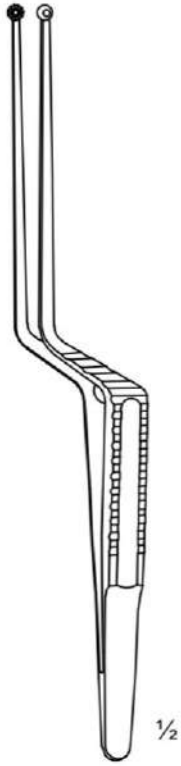

**HUNT**



**YASARGIL**  
Flat jaws, serrated

02-1501 20.0 cm

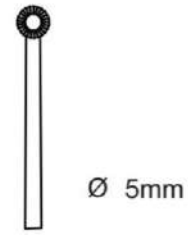

**HUNT**  
Flat jaws, serrated

02-1502 20.0 cm



Fine tips

02-1601 18.5 cm



Blunt tips

02-1602 18.5 cm



Blunt tips

02-1612 18.5 cm



Ø 5mm  
Flat jaws, serrated

02-1701 20.0 cm

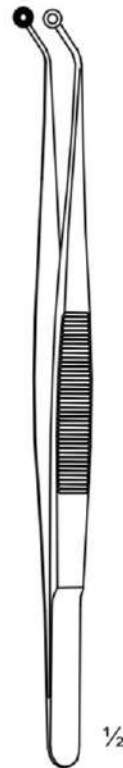

**HUNT**



Tips 1.5mm

02-1801	16.0 cm
02-1802	20.0 cm
02-1803	24.0 cm
02-1804	30.0 cm



DE BAKEY



Tips 2.0mm

02-1901	16.0 cm
02-1902	20.0 cm
02-1903	24.0 cm
02-1904	30.0 cm



Tips 1.5mm



Tips 2.0mm



Tips 2.4mm

02-2001	16.0 cm
02-2002	20.0 cm
02-2003	24.0 cm
02-2004	30.0 cm

02-2101	16.0 cm
02-2102	20.0 cm
02-2103	24.0 cm
02-2104	30.0 cm



02-2111	16.0 cm
02-2112	20.0 cm
02-2113	24.0 cm
02-2114	30.0 cm



02-2201	16.0 cm
02-2202	20.0 cm
02-2203	24.0 cm
02-2204	30.0 cm



02-2211	16.0 cm
02-2212	20.0 cm
02-2213	24.0 cm
02-2214	30.0 cm

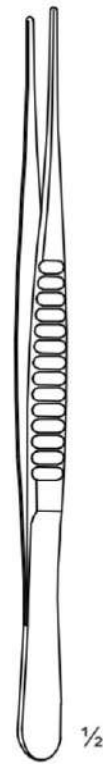

DE BAKEY

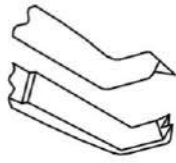
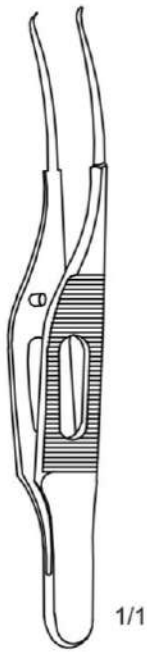

02-2301 8.3 cm

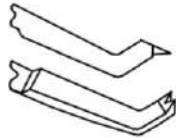

Extra delicate

02-2302 8.3 cm

**COLIBRI**  
With tying platform

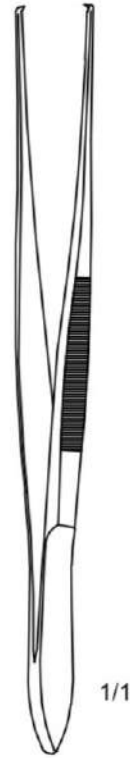

**UTILITY**

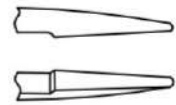
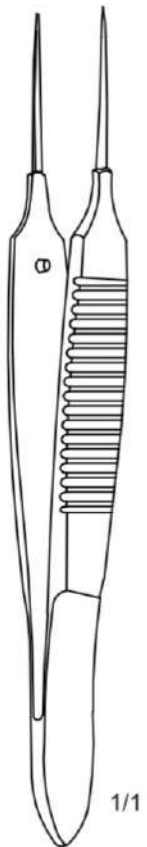

02-2601 11.0 cm

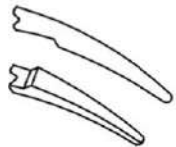

02-2602 11.0 cm

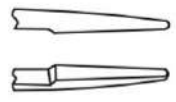

delicate

02-2603 11.0 cm

**TUBINGEN**  
Suture Forceps

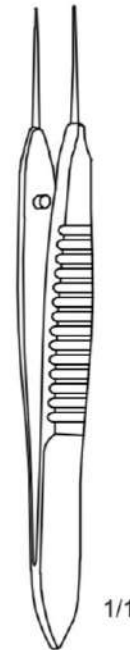

**BONN**  
Suture Forceps





**BARSEWISCH**  
Anterior Chamber Forceps  
02-2804

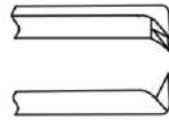

1x2 teeth, straight  
02-2801 6.0 mm

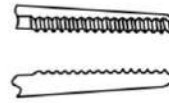

straight  
02-2901 6.0 mm

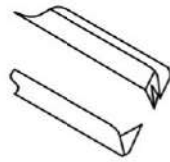

1x2 teeth, angled  
02-2802 6.0 mm

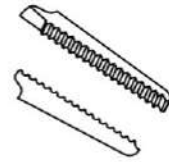

angled  
02-2902 6.0 mm

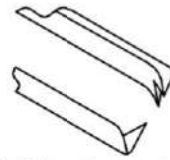

1x2 teeth, angled  
02-2803 8.0 mm



angled  
02-2903 8.0 mm

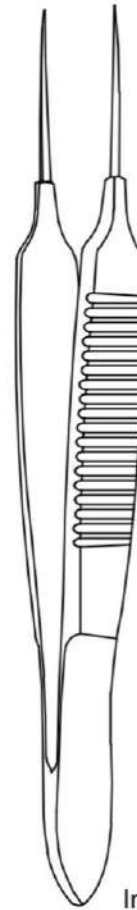

**BONN**  
Iris Forceps

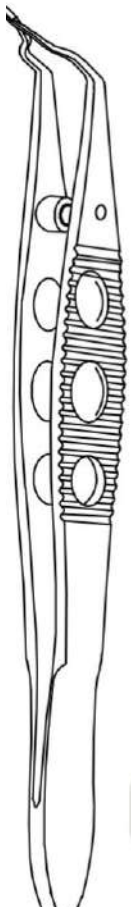

**MC DONALDS  
-SPALECK**  
Lense Implantation  
Forceps

02-3001 5.0 mm  
02-3002 6.0 mm

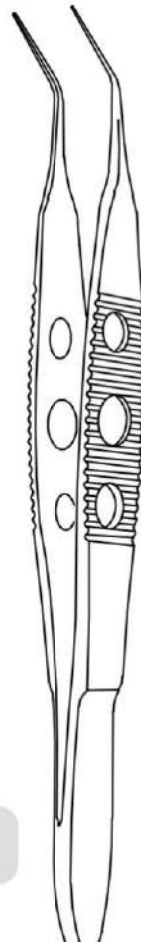

**FAULKNER**  
Holding Forceps

angled  
02-3101 5.0 mm  
02-3102 6.0 mm  
02-3103 11.0 mm

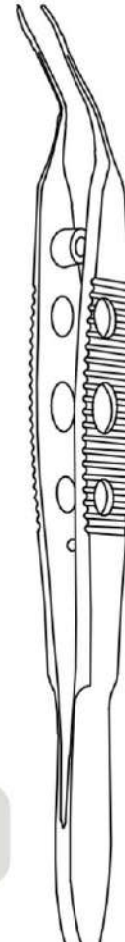

**SPALECK  
-MICROMA**  
Lense Implantation  
Forceps

*Silicone  
rough*

02-3201 5.6 mm  
02-3202 6.6 mm

*Acrylic  
glazed*

02-3203 5.6 mm  
02-3204 6.6 mm

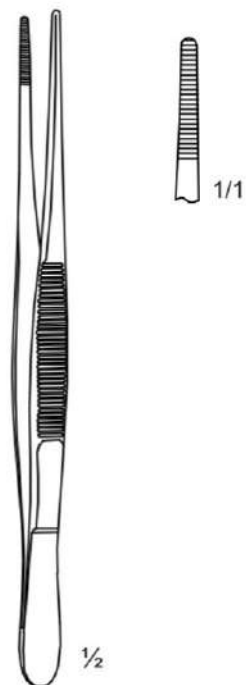

03-0101	14.5 cm
03-0102	16.0 cm
03-0103	18.0 cm
03-0104	20.0 cm
03-0105	25.0 cm

**T-C DRESSING FORCEPS**  
Standard patterns

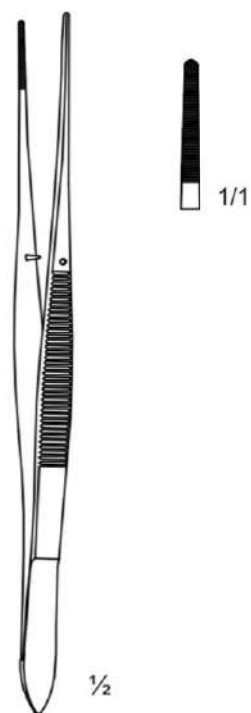

03-0201	16.0 cm
03-0202	18.0 cm
03-0203	20.0 cm
03-0204	23.0 cm
03-0205	25.0 cm

**T-C POTTS-SMITH**

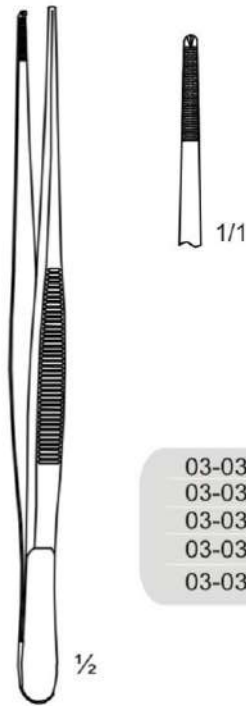

03-0301	14.5 cm
03-0302	16.0 cm
03-0303	18.0 cm
03-0304	20.0 cm
03-0305	25.0 cm

**T-C OEHLER**  
Tissue Forceps, 1x2 teeth

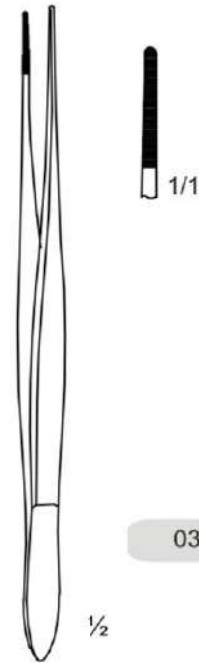

03-0901 | 18.0 cm

**T-C CUSHING**  
With dissector end

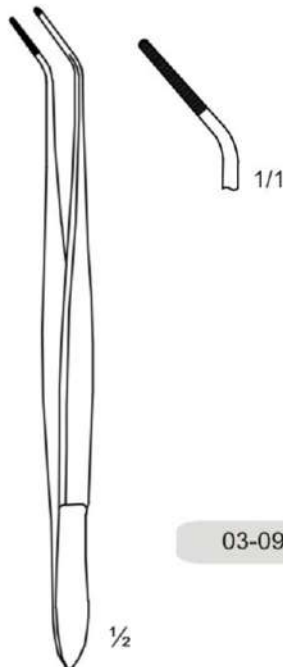

03-0911 | 18.0 cm

**T-C CUSHING**  
With dissector end

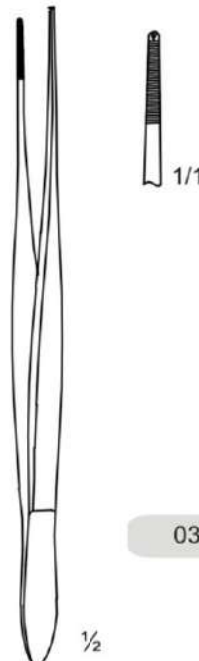

03-1001 | 18.0 cm

**T-C CUSHING**  
1x2 teeth

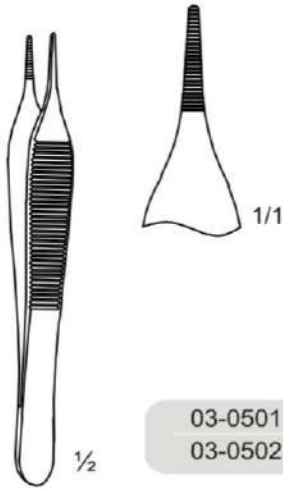

03-0501	12.0 cm
03-0502	15.0 cm

1/2

T-C ADSON

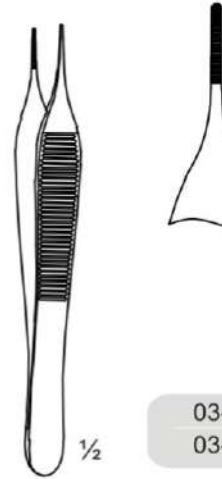

03-	
03-	

1/2

T-C MICRO ADSON

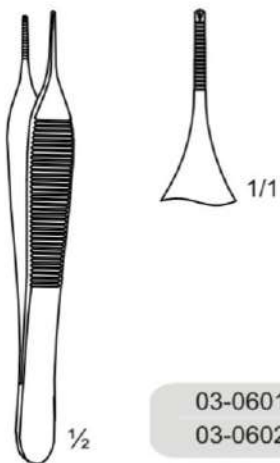

03-0601	12.0 cm
03-0602	15.0 cm

1/2

T-C ADSON  
1x2 teeth

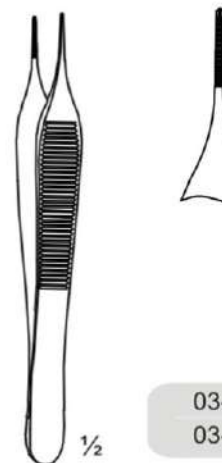

03-	
03-	

1/2

T-C MICRO ADSON  
1x2 teeth



03-0701	12.0 cm
03-0702	15.0 cm

**TC-ADSON-BROWN**  
3x4 teeth

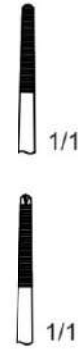

03-1102	15.5 cm	
03-1202	15.5 cm	1x2 teeth

**TC-SEMKEN**  
With dissector end

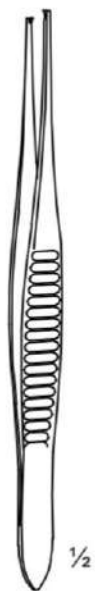

03-3401	15.0 cm
---------	---------

**TC-GILLIES**  
1x2 teeth



03-3411	15.0 cm
---------	---------

**TC-MC INDOE**

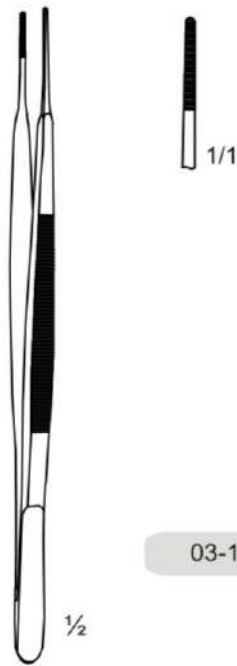

TC- GERALD

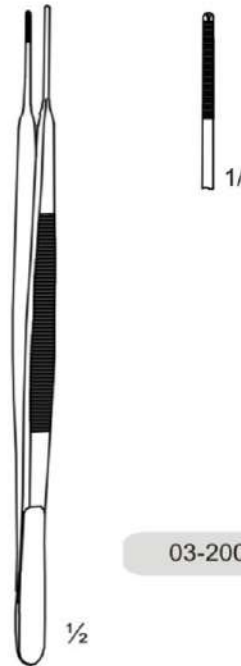

TC- GERALD  
1x2 teeth

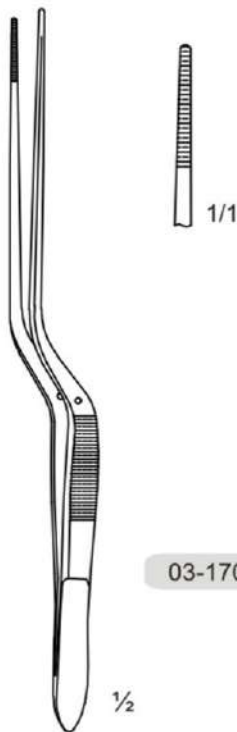

TC- GRUENWALD

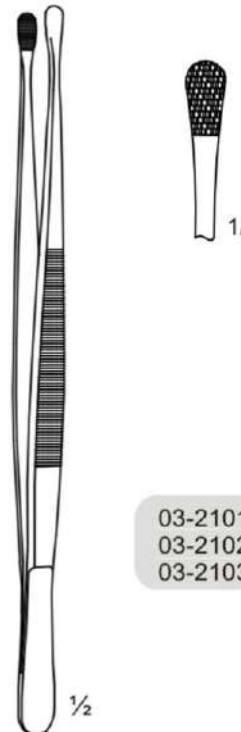

TC- WANGENSTEEN



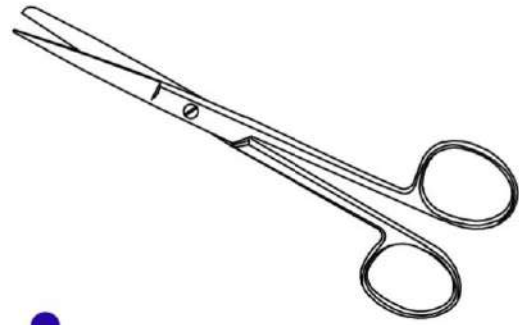

# Scissors

Scissors

- *Scissors*
- *Scissors SC*
- *Scissors TC*
- *Scissors TC SC*
- *Micro Scissors*



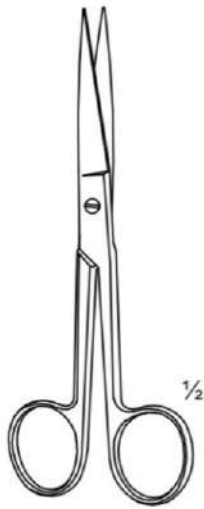

**OPERATING**



► 04-0101	14.0 cm	Straight	Sharp/Sharp
04-0102	17.0 cm	Straight	Sharp/Sharp

► 04-0111	14.0 cm	Curved	Sharp/Sharp
04-0112	17.0 cm	Curved	Sharp/Sharp

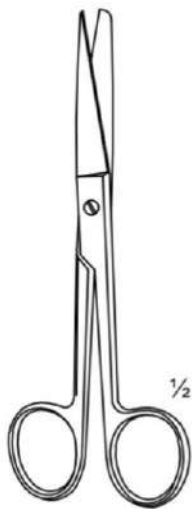

**OPERATING**

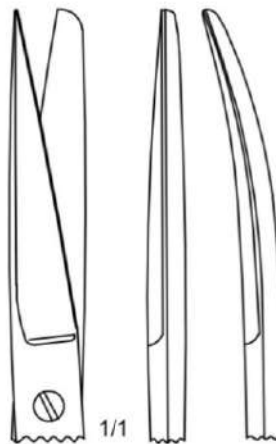

► 04-0201	14.0 cm	Straight	Sharp/Blunt
04-0202	17.0 cm	Straight	Sharp/Blunt

► 04-0211	14.0 cm	Curved	Sharp/Blunt
04-0212	17.0 cm	Curved	Sharp/Blunt

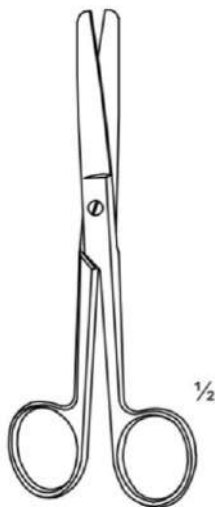

**OPERATING**



► 04-0301	14.0 cm	Straight	Blunt/Blunt
04-0302	17.0 cm	Straight	Blunt/Blunt

► 04-0311	14.0 cm	Curved	Blunt/Blunt
04-0312	17.0 cm	Curved	Blunt/Blunt

# Surgical & Dissecting Scissors

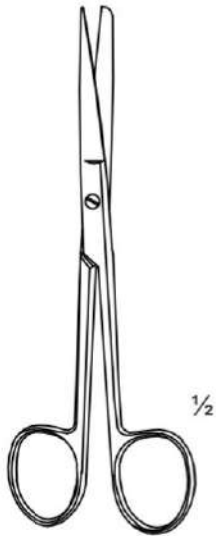

1/2

**DEAVER**  
Slender type

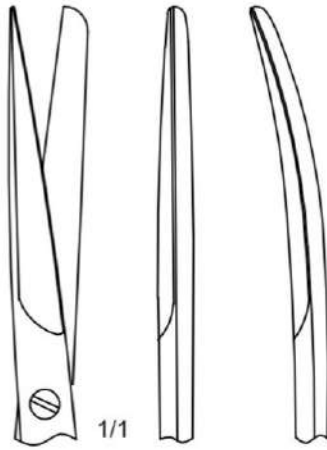

1/1

- 04-0203 14.0 cm
- 04-0213 14.0 cm

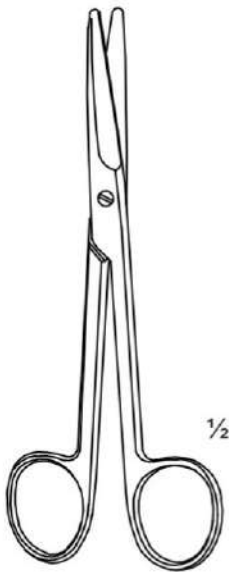

1/2

**MAYO**

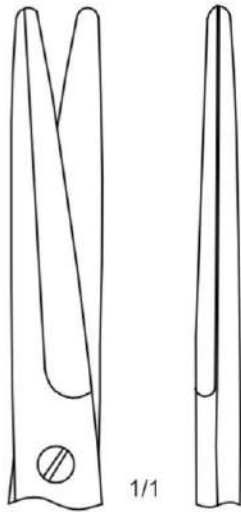

1/1

- ▶ 04-0401
- ▶ 04-0402
- 04-0403
- 04-0404
- 04-0405



1/1

- ▶ 04-0411
- ▶ 04-0412
- 04-0413
- 04-0414
- 04-0415

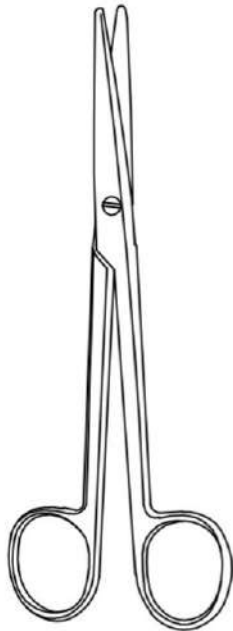

1/2

**MAYO-STILLE**

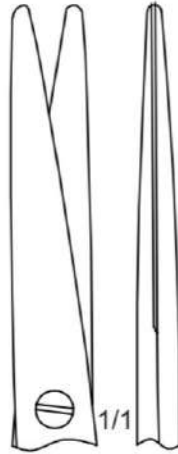

1/1

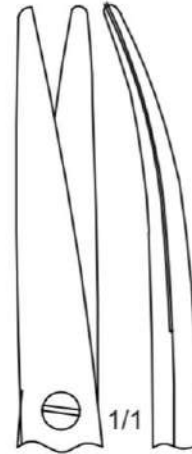

1/1

04-0501	15.0 cm	Straight
04-0502	17.0 cm	Straight
04-0503	19.0 cm	Straight
04-0504	21.0 cm	Straight
04-0505	23.0 cm	Straight

04-0511	15.0 cm	Curved
04-0512	17.0 cm	Curved
04-0513	19.0 cm	Curved
04-0514	21.0 cm	Curved
04-0515	23.0 cm	Curved

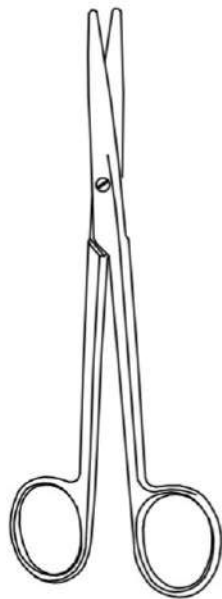

1/2

**MAYO-LEXER**

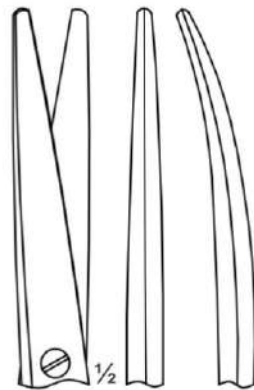

1/2

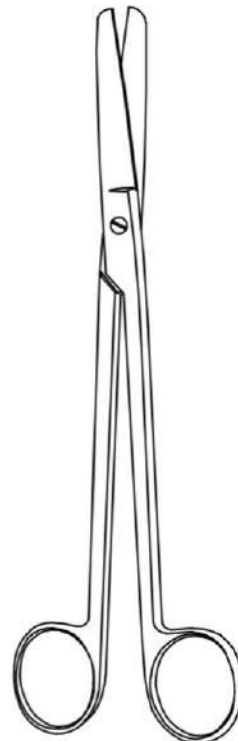

1/2

**SIMS**

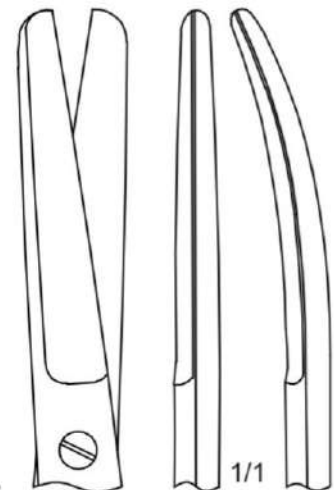

1/1

04-0601	16.0 cm	Straight
04-0602	21.0 cm	Straight
04-0611	16.0 cm	Curved
04-0612	21.0 cm	Curved

▶ 04-0701	20.0 cm	Straight
04-0702	23.0 cm	Straight
▶ 04-0711	20.0 cm	Curved
04-0712	23.0 cm	Curved

**Delicate Scissors**

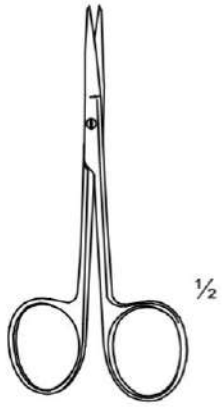

**IRIS**



04-0801	10.0 cm	Straight
▶ 04-0802	11.0 cm	Straight

04-0811	10.0 cm	Curved
▶ 04-0812	11.0 cm	Curved

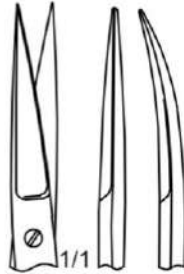

04-0803	12.0 cm	Straight
04-0813	12.0 cm	Curved

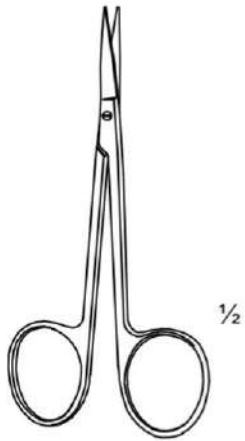

**EYE**

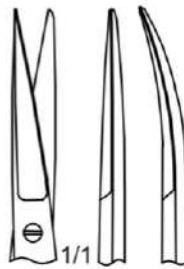

04-0804	12.0 cm	Straight
04-0814	12.0 cm	Curved

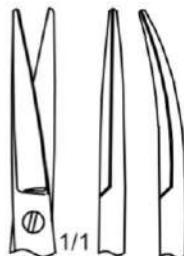

04-0805	12.0 cm	Straight
04-0815	12.0 cm	Curved



**STEVENS**  
Vessel-and tendon  
scissors

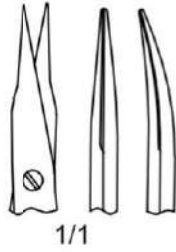

1/1

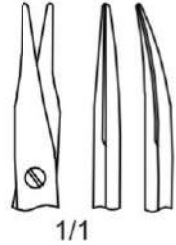

1/1

▶ 04-0901	10.5 cm	Straight	Sharp
▶ 04-0911	10.5 cm	Curved	Sharp

▶ 04-1001	10.5 cm	Straight	Blunt
▶ 04-1011	10.5 cm	Curved	Blunt

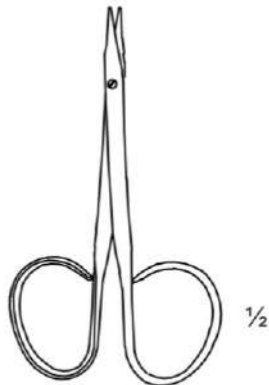

**STEVENS**  
Flat shanks and  
large ergonomic rings

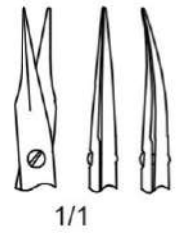

1/1

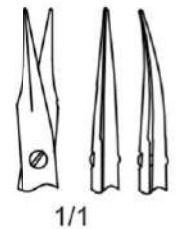

1/1

▶ 04-0902	10.5 cm	Straight	Sharp
▶ 04-0912	10.5 cm	Curved	Sharp

▶ 04-1002	10.5 cm	Straight	Blunt
▶ 04-1012	10.5 cm	Curved	Blunt

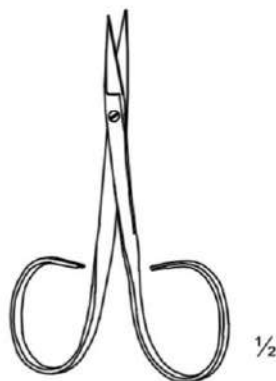

**IRIS**  
Flat shanks and  
large ergonomic rings

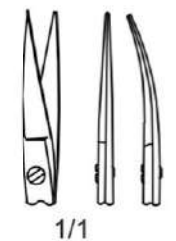

1/1

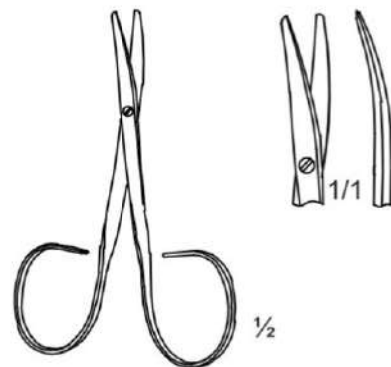

**UTILITY**  
Flat shanks and  
large ergonomic rings



1/1

▶ 04-1101	9.5 cm	Straight	Sharp
▶ 04-1111	9.5 cm	Curved	Sharp

▶ 04-1200	9.5 cm	Curved	Blunt
-----------	--------	--------	-------

**Delicate Scissors**

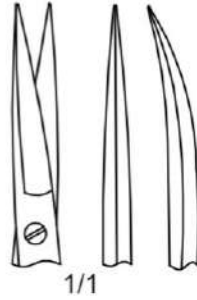

04-1201	10.0 cm	Straight
04-1211	10.0 cm	Curved

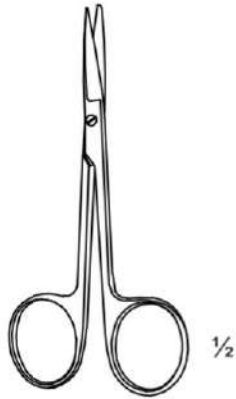

**COTTLE KNAPP**



04-1202	10.0 cm	Straight
04-1212	10.0 cm	Curved

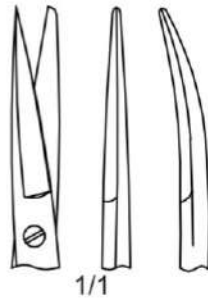

04-1203	10.0 cm	Straight
04-1213	10.0 cm	Curved

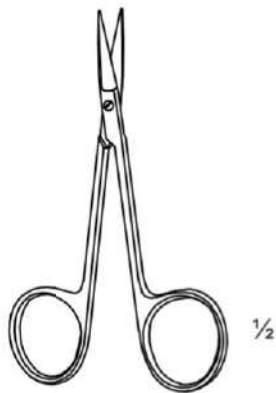

**FINE**

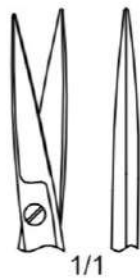

04-1301	9.0 cm	Straight
04-1302	10.0 cm	Straight
04-1303	11.0 cm	Straight



04-1311	9.0 cm	Curved
04-1312	10.0 cm	Curved
04-1313	11.0 cm	Curved



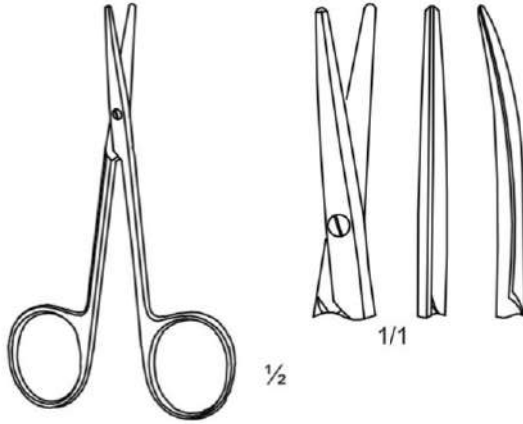

**STRABISMUS**

04-1401	11.0 cm	Straight
04-1411	11.0 cm	Curved

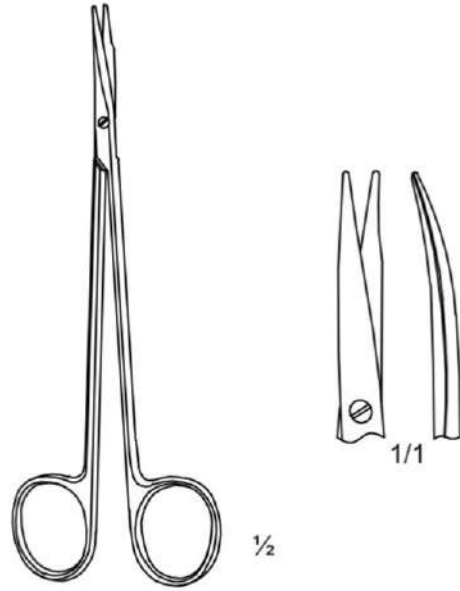

**JAMESON**

04-1501	14.5 cm	
04-1502	14.5 cm	Fine tips

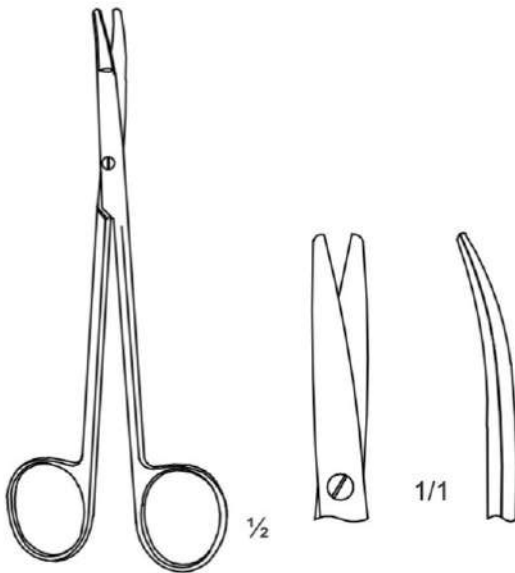

**KILNER**

Special flat points for dissecting and undermining the skin

04-1601	12.0 cm	Curved
04-1602	13.0 cm	Curved
04-1603	15.0 cm	Curved

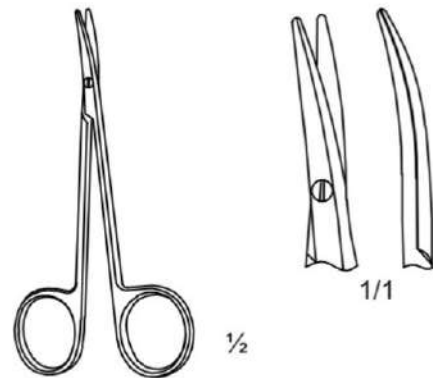

**KAYE**

▶ 04-1700	11.5 cm	Curved
-----------	---------	--------

# Rhinoplasty Dissecting Scissors

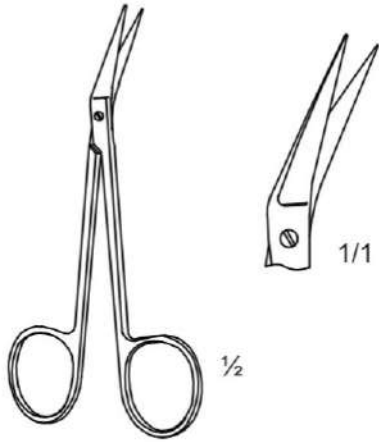

**GOLDMANN**  
Angled to side

▶ 04-1800 11.0 cm

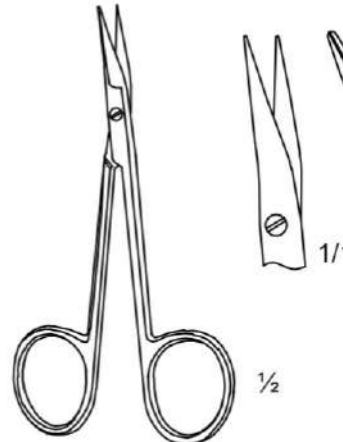

**GOLDMANN**  
Angled on flat

▶ 04-1801 11.0 cm

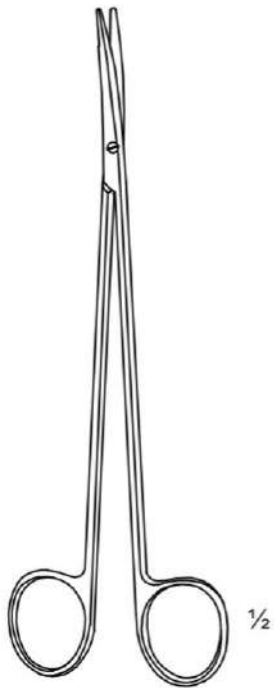

**TOENNIS-ADSON**  
very delicate pattern

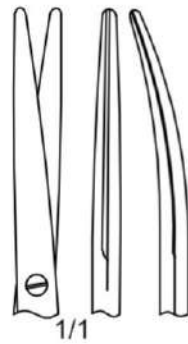

04-1810	18.0 cm	Straight
04-1820	18.0 cm	Curved

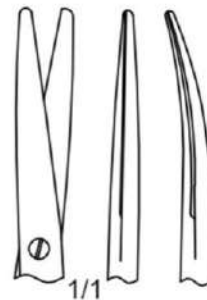

04-1901	11.0 cm	Straight
04-1911	11.0 cm	Curved





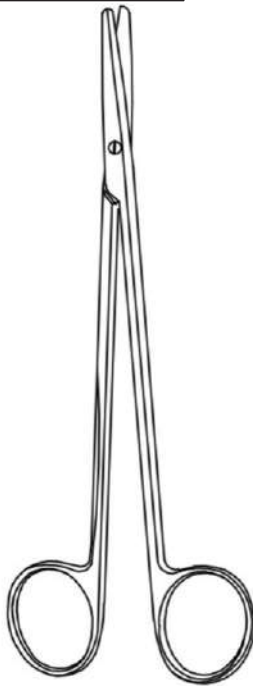

**METZEMBAUM**  
Standard pattern

1/2

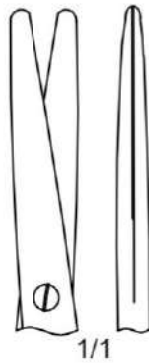

1/1

▶ 04-1902	14.0 cm	Straight	Blunt/Blunt
▶ 04-1903	18.0 cm	Straight	Blunt/Blunt
▶ 04-1904	20.0 cm	Straight	Blunt/Blunt
▶ 04-1905	23.0 cm	Straight	Blunt/Blunt
04-1906	25.0 cm	Straight	Blunt/Blunt
04-1907	28.0 cm	Straight	Blunt/Blunt
04-1908	30.0 cm	Straight	Blunt/Blunt

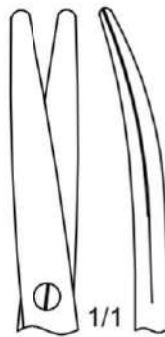

1/1

▶ 04-1912	14.0 cm	Curved	Blunt/Blunt
▶ 04-1913	18.0 cm	Curved	Blunt/Blunt
▶ 04-1914	20.0 cm	Curved	Blunt/Blunt
▶ 04-1915	23.0 cm	Curved	Blunt/Blunt
04-1916	25.0 cm	Curved	Blunt/Blunt
04-1917	28.0 cm	Curved	Blunt/Blunt
04-1918	30.0 cm	Curved	Blunt/Blunt

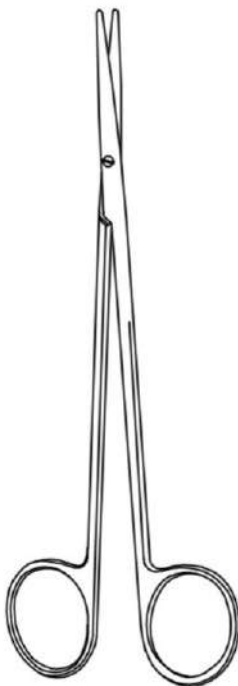

**METZEMBAUM-FINO**  
Delicate pattern

1/2

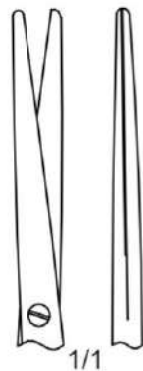

1/1

04-2001	14.0 cm	Straight	Blunt/Blunt
04-2002	18.0 cm	Straight	Blunt/Blunt
04-2003	20.0 cm	Straight	Blunt/Blunt
04-2004	23.0 cm	Straight	Blunt/Blunt
04-2005	25.0 cm	Straight	Blunt/Blunt
04-2006	28.0 cm	Straight	Blunt/Blunt



1/1

04-2011	14.0 cm	Curved	Blunt/Blunt
04-2012	18.0 cm	Curved	Blunt/Blunt
04-2013	20.0 cm	Curved	Blunt/Blunt
04-2014	23.0 cm	Curved	Blunt/Blunt
04-2015	25.0 cm	Curved	Blunt/Blunt
04-2016	28.0 cm	Curved	Blunt/Blunt

# Dissecting & Episiotomy Scissors

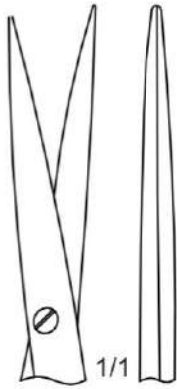
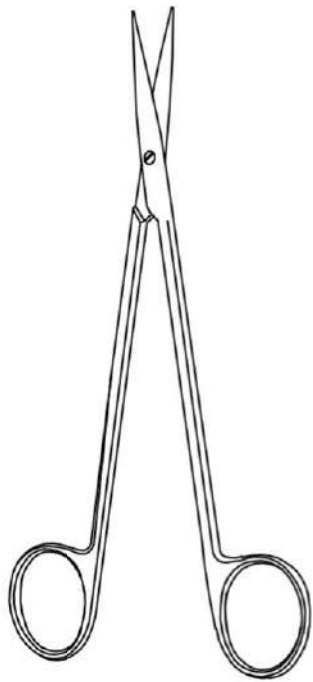

04-2101	14.0 cm	S
04-2102	18.0 cm	S
04-2103	20.0 cm	S
04-2104	23.0 cm	S
04-2105	25.0 cm	S
04-2106	28.0 cm	S

**METZEMBAUM-FINO**  
Delicate pattern

1/2

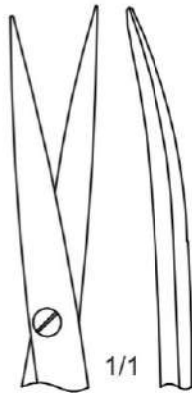

1/1

04-2111	14.0 cm	C
04-2112	18.0 cm	C
04-2113	20.0 cm	C
04-2114	23.0 cm	C
04-2115	25.0 cm	C
04-2116	28.0 cm	C

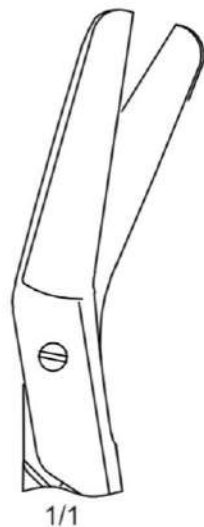
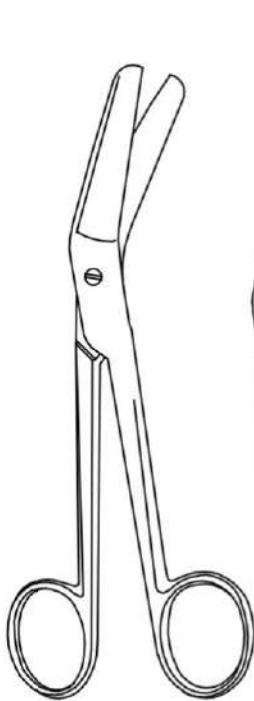

1/1

1/2

**FERGUSON**  
Curved to side

► 04-2200 18.0 cm

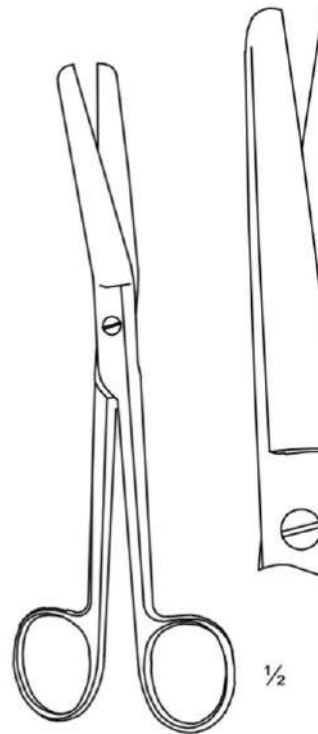

1/2

**FERGUSON**  
Curved on side flat

► 0

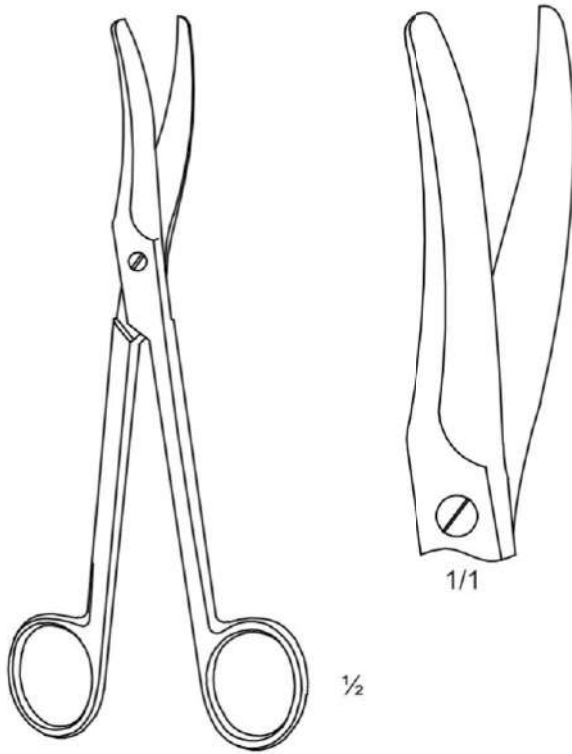

**EPISIOTOMY**

04-2300 | 19.0 cm

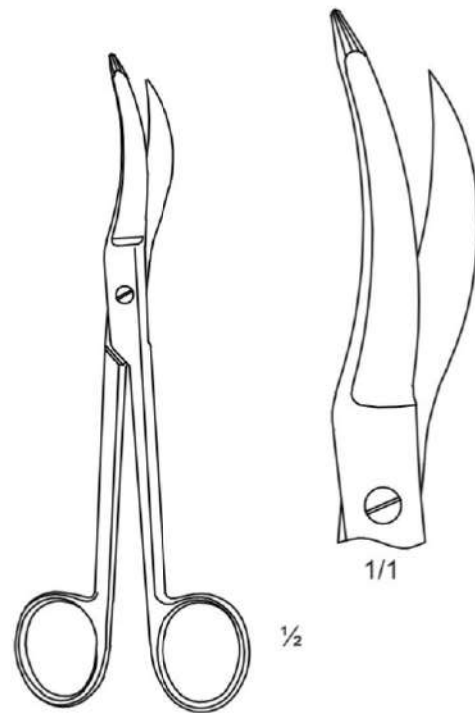

**WALDMANN**

04-2400 | 19.0 cm

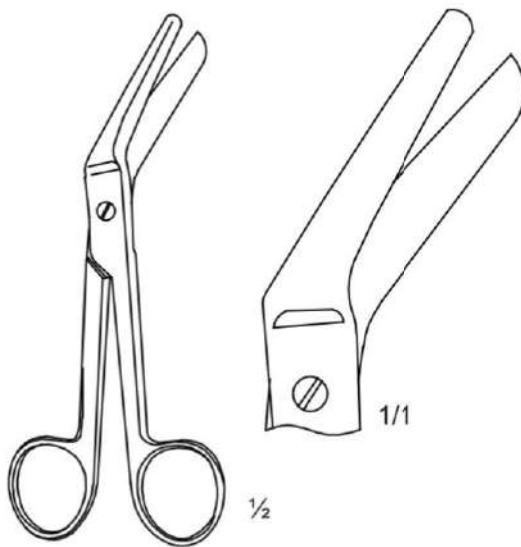

**BRAUN**

▶ 04-2501 | 14.0 cm  
▶ 04-2502 | 21.5 cm

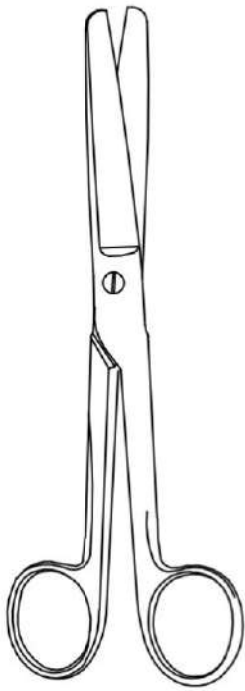

1/2



1/1

- ▶ 04-2601 17.5
- ▶ 04-2611 17.5

**DOYEN**

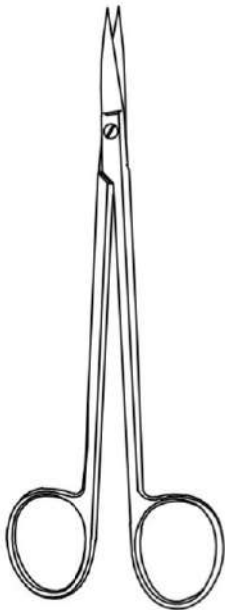

1/2

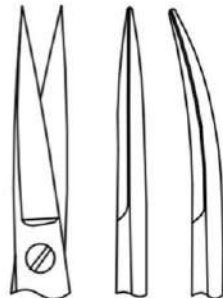

1/1

**KELLY**

- ▶ 04-2701 16.0 cm Straight
- ▶ 04-2711 16.0 cm Curved

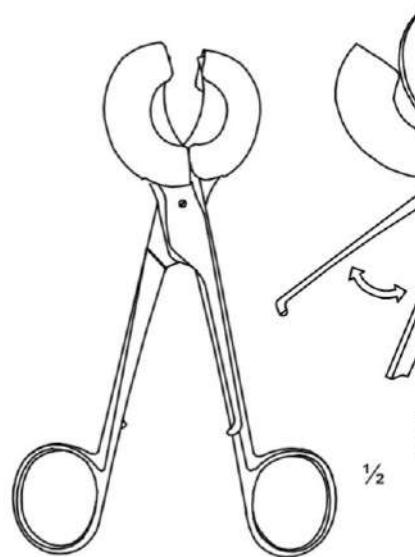

1/2

**DOO'S CORD**

- ▶ 04-2800 14.0 cm

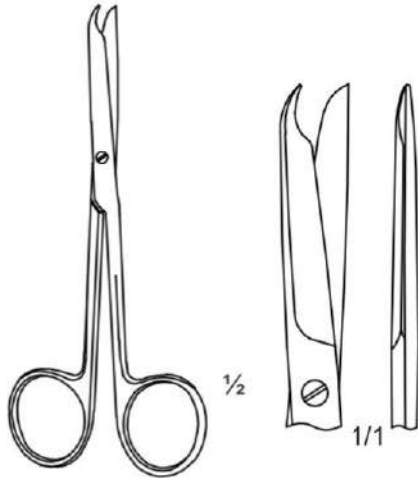

**SPENCER**

► 04-2902 | 12.5 cm

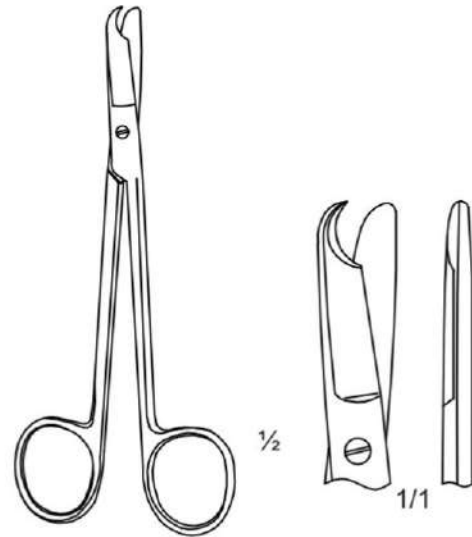

**LITTAUER**

► 04-2903 | 14.0 cm

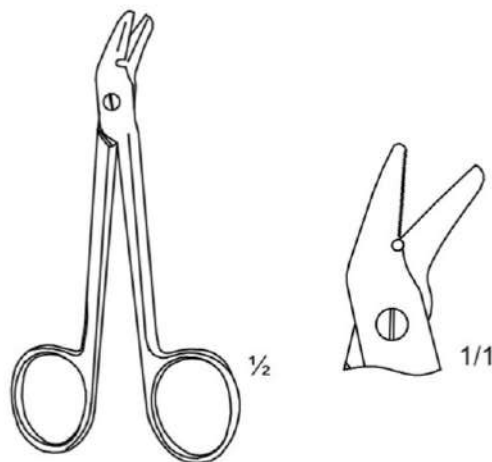

**UNIVERSAL**  
Wire Cutting

► 04-3000 | 12.0 cm | Curved

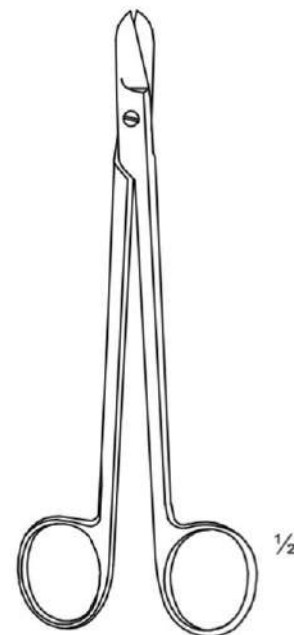

**SMITH**  
Wire Cutting

04-3001 | 16.0 cm



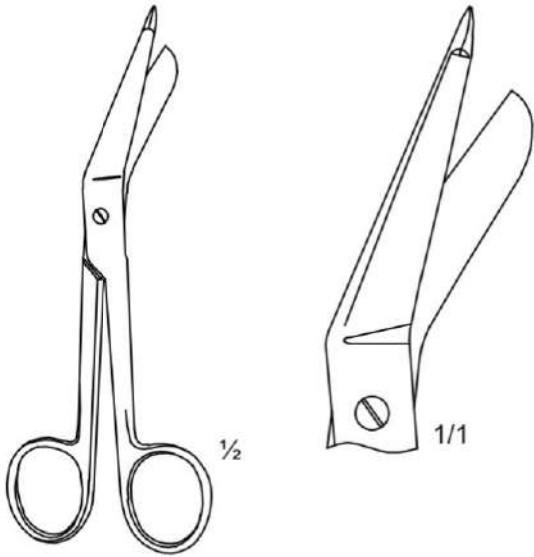

**LISTER**

- ▶ 04-3101      14.0 cm
- ▶ 04-3102      18.0 cm
- ▶ 04-3103      20.0 cm

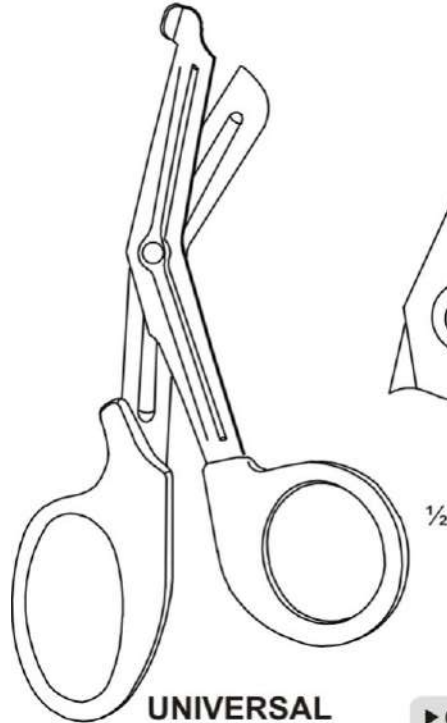

**UNIVERSAL**  
One blade serrated

- ▶ 04-3110      18.0 cm

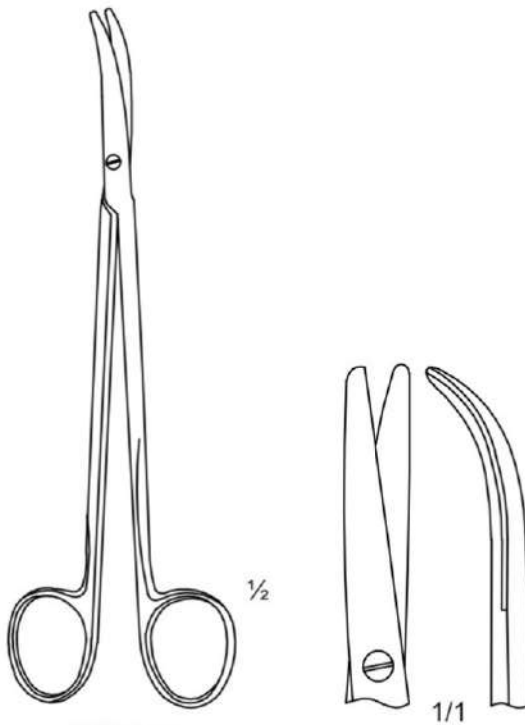

**HALLE**  
Nasal Scissors

- ▶ 04-3200      19.0 cm

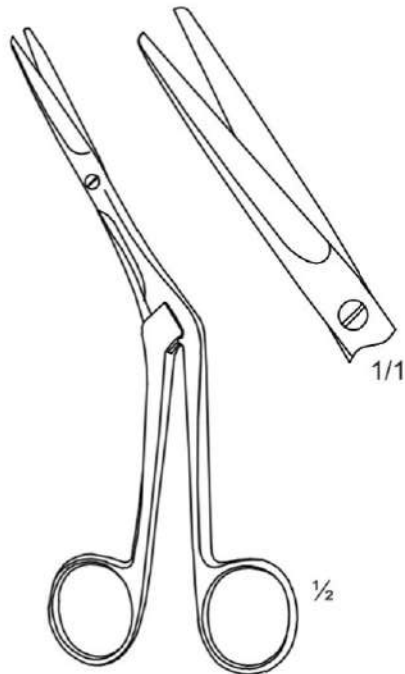

**HEYMANN-KNIGHT**  
Nasal Scissors

▶ 04-3201 18.0 cm Blunt

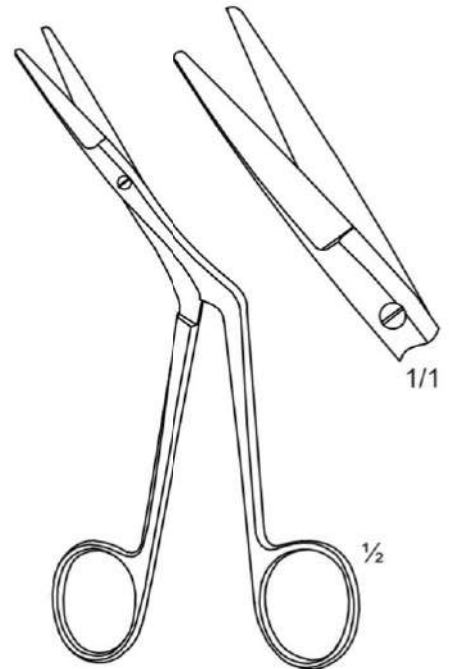

**HEYMANN**  
Nasal Scissors

▶ 04-3202 18.0 cm Blunt

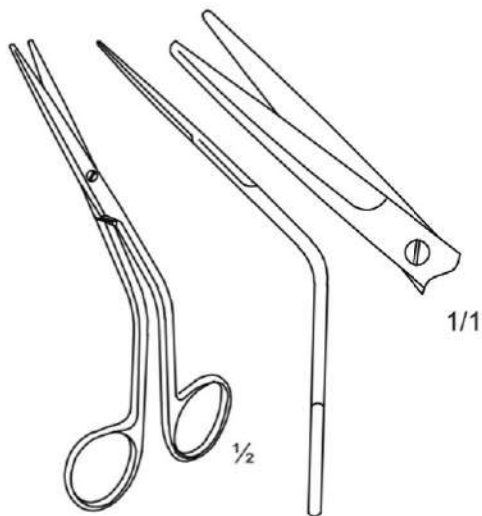

**FOMON**  
Nasal Scissors

▶ 04-3203 14.0 cm Blunt

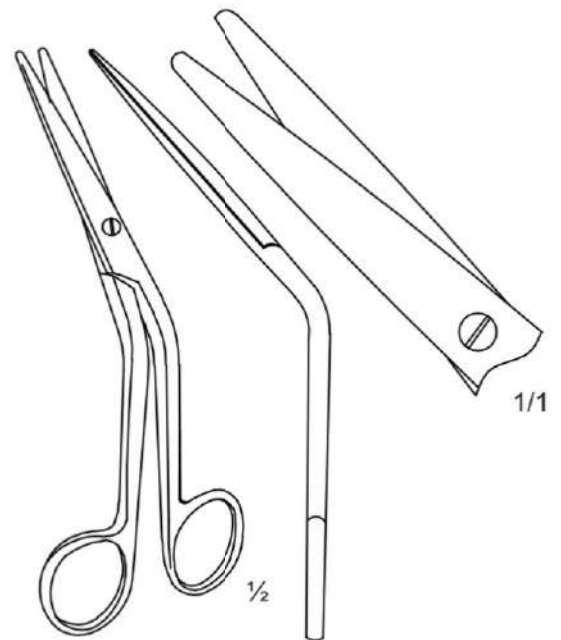

**COTTLE**  
Nasal Scissors

▶ 04-3204 16.0 cm Blunt

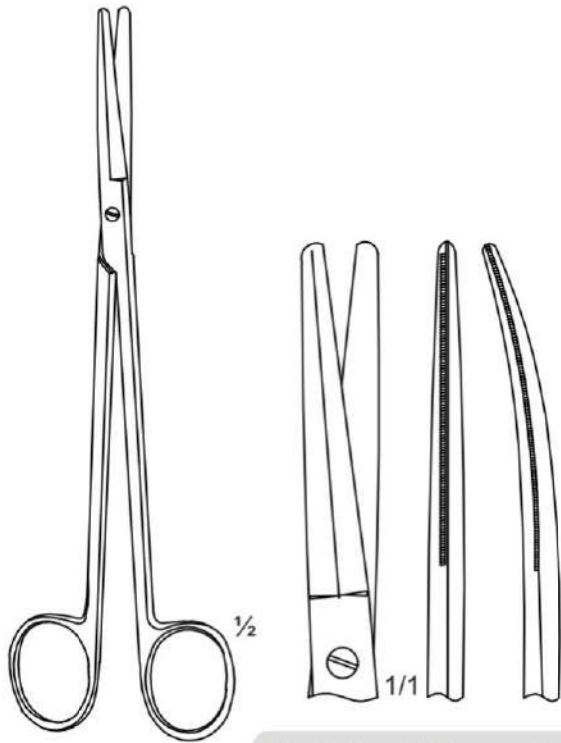

**GORNEY**  
Dissecting Scissors

04-3301	19.0 cm	Straight
04-3311	19.0 cm	Curved

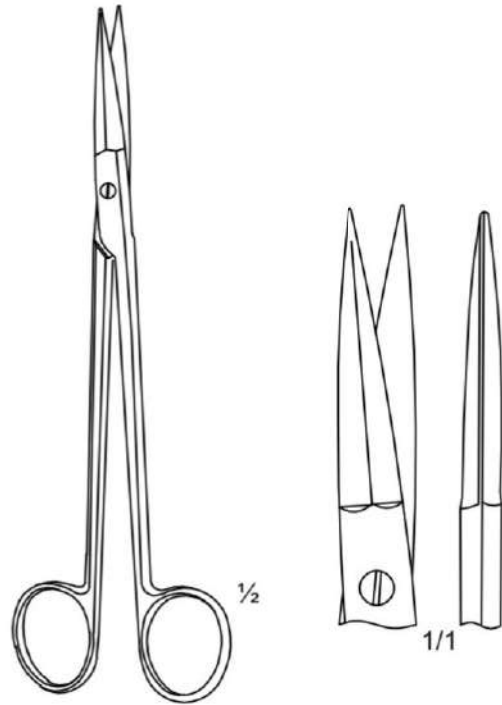

**MC INDOE**

04-3400	19.0 cm	Straight
---------	---------	----------

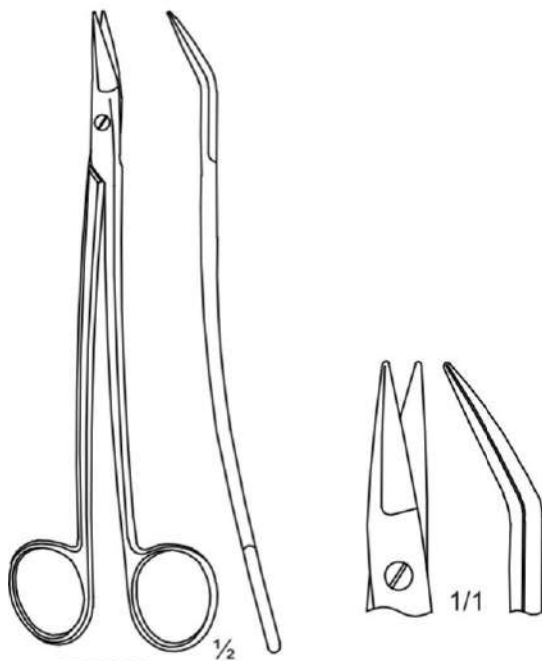

**DEAN**  
Curved on flat

04-3501	15.0 cm
04-3502	17.0 cm

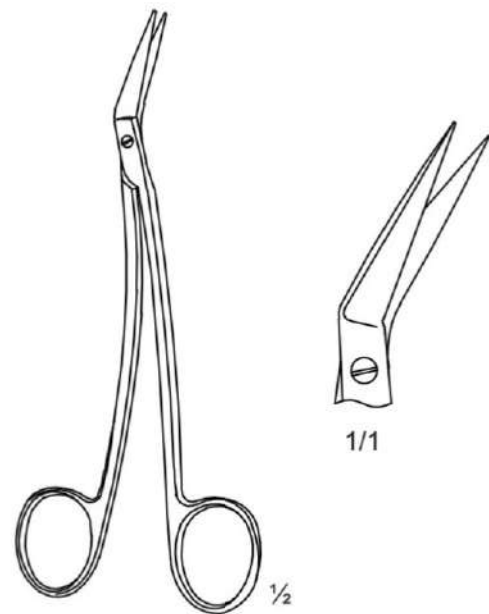

**LOCKLIN**  
Curved to side

04-3600	16.5 cm
---------	---------





25°

1/1

04-3701

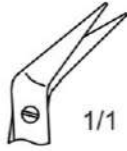

45°

1/1

04-3702



60°

1/1

04-3703

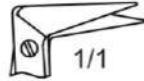

90°

1/1

04-3704



125°

1/1

04-3705

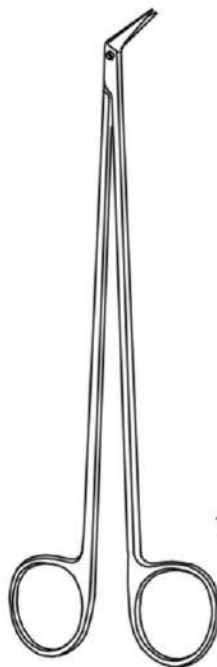

1/2

**HEGEMANN**  
Curved to side



25°

1/1

04-3801



45°

1/1

04-3802



60°

1/1

04-3803

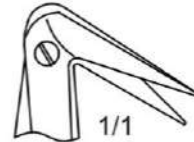

125°

1/1

04-3804

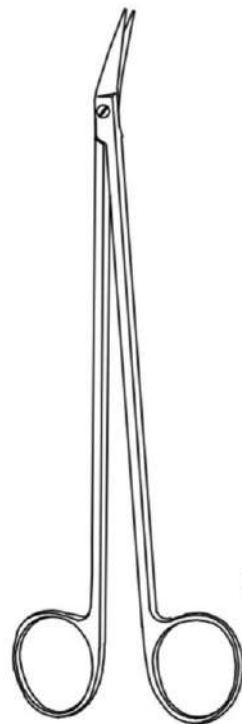

1/2

**POTTS-SMITH**  
Curved to side

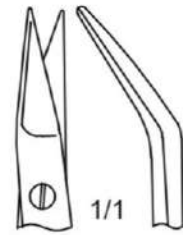

1/1

04-3901	17.0 cm
04-3902	19.5 cm

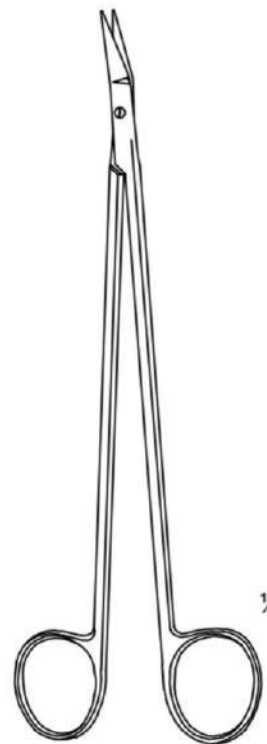

1/2

**POTTS-SMITH**  
Curved on flat

**Surgical Scissors SC**

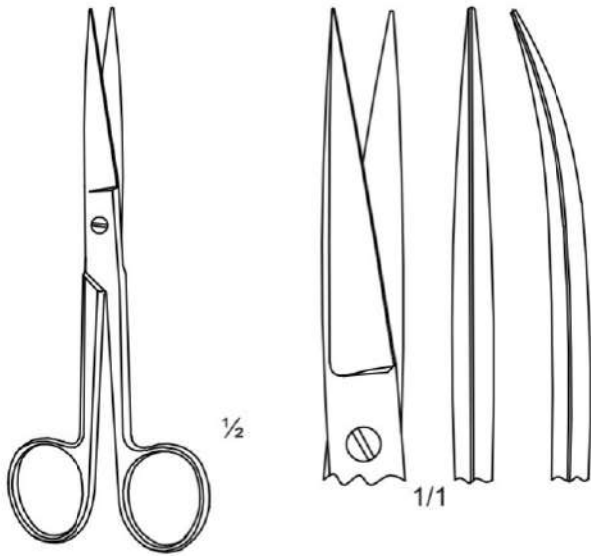

**OPERATING**

05-0101	14.0 cm	Straight	Sharp/Sharp
05-0102	17.0 cm	Straight	Sharp/Sharp
05-0111	14.0 cm	Curved	Sharp/Sharp
05-0112	17.0 cm	Curved	Sharp/Sharp

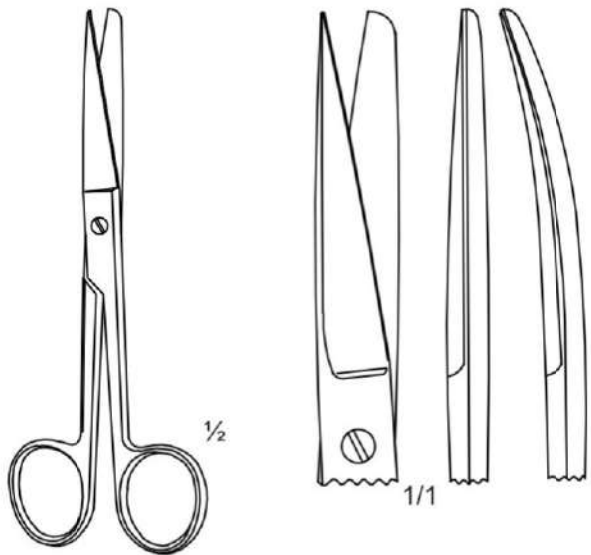

**OPERATING**

05-0201	14.0 cm	Straight	Sharp/Blunt
05-0202	17.0 cm	Straight	Sharp/Blunt
05-0211	14.0 cm	Curved	Sharp/Blunt
05-0212	17.0 cm	Curved	Sharp/Blunt

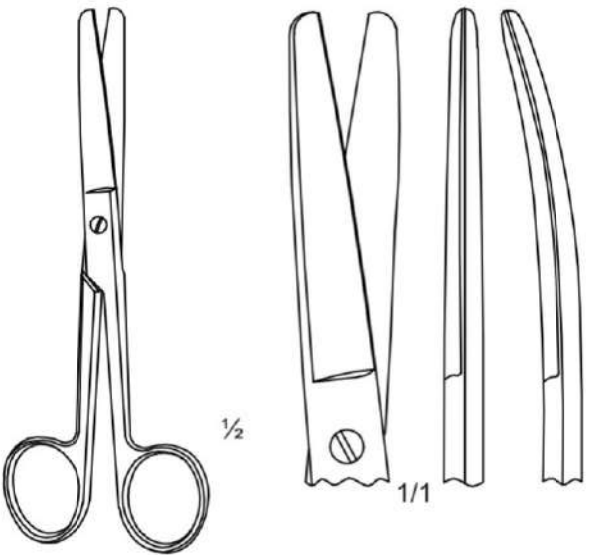

**OPERATING**

05-0301	14.0 cm	Straight	Blunt/Blunt
05-0302	17.0 cm	Straight	Blunt/Blunt
05-0311	14.0 cm	Curved	Blunt/Blunt
05-0312	17.0 cm	Curved	Blunt/Blunt

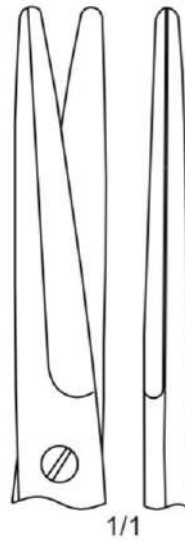
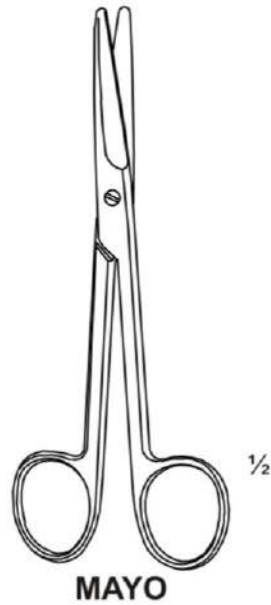

05-0401	14.5 cm	Straight
05-0402	17.0 cm	Straight
05-0403	20.0 cm	Straight
05-0404	23.0 cm	Straight
05-0405	28.0 cm	Straight



05-0411	14.5 cm	Curved
05-0412	17.0 cm	Curved
05-0413	20.0 cm	Curved
05-0414	23.0 cm	Curved
05-0415	28.0 cm	Curved

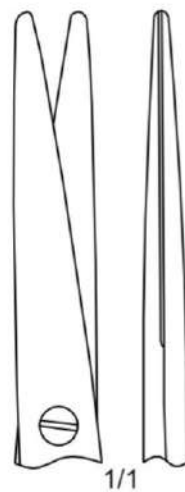
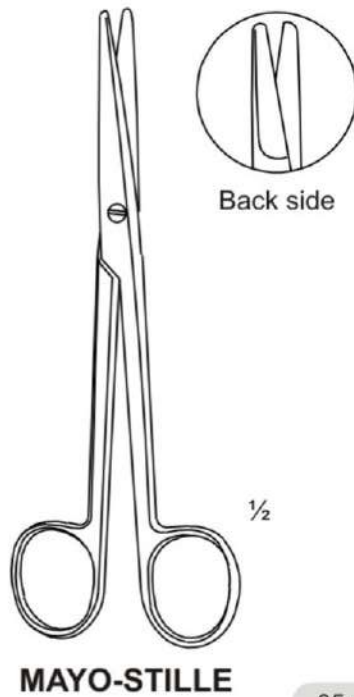

05-0501	15.0 cm	Straight
05-0502	17.0 cm	Straight
05-0503	19.0 cm	Straight
05-0504	21.0 cm	Straight
05-0505	23.0 cm	Straight

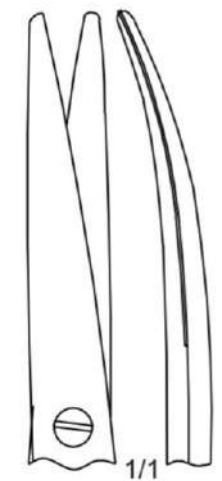

05-0511	15.0 cm	Curved
05-0512	17.0 cm	Curved
05-0513	19.0 cm	Curved
05-0514	21.0 cm	Curved
05-0515	23.0 cm	Curved

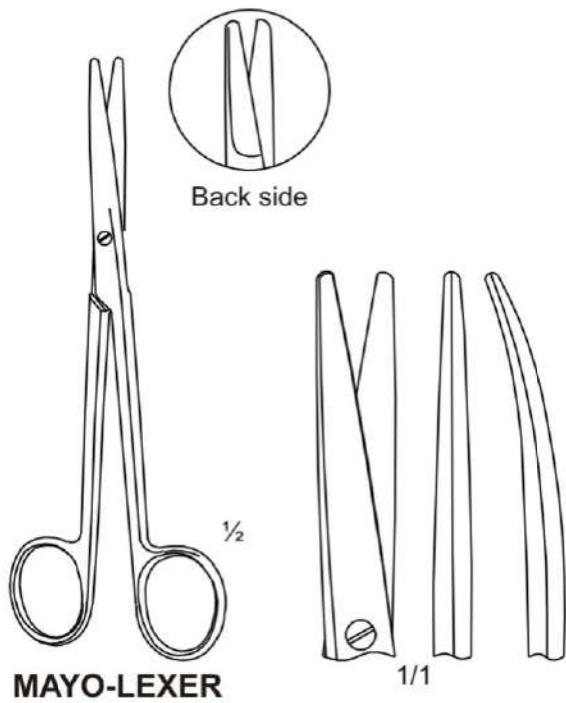

05-0601	16.0 cm	Straight
05-0602	21.0 cm	Straight

05-0611	16.0 cm	Curved
05-0612	21.0 cm	Curved

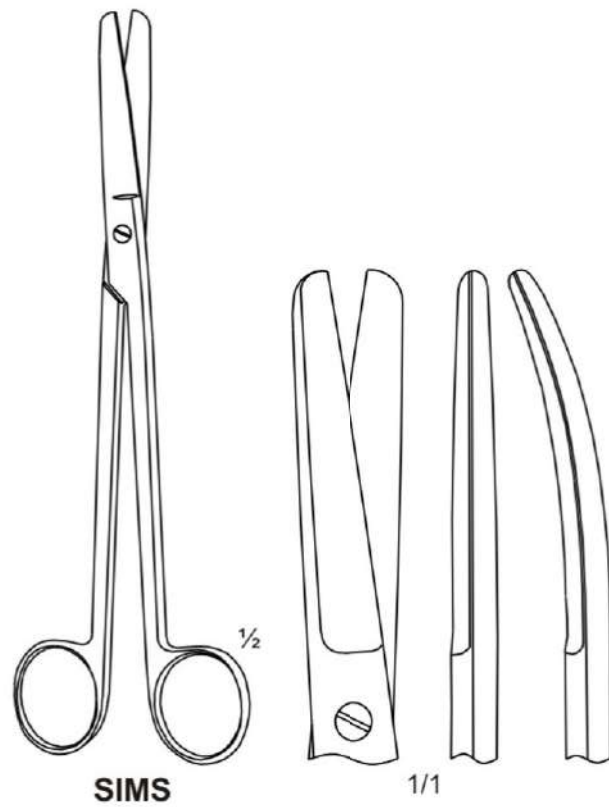

05-0701	20.0 cm	Straight
05-0702	23.0 cm	Straight

05-0711	20.0 cm	Curved
05-0712	23.0 cm	Curved

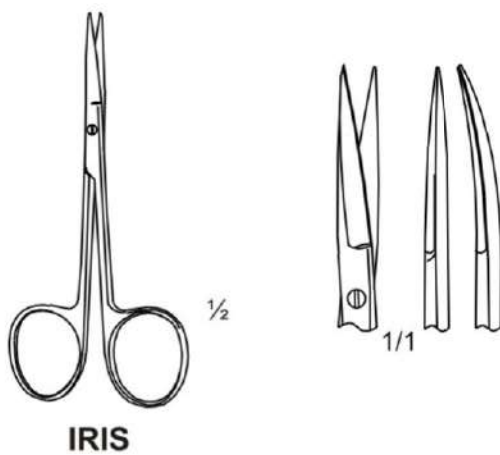

05-0801	10.0 cm	Straight
05-0802	11.0 cm	Straight

05-0811	10.0 cm	Curved
05-0812	11.0 cm	Curved

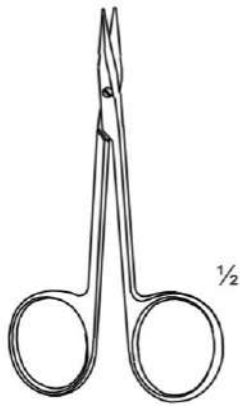

**STEVENS**  
Vessel and tendon  
scissors

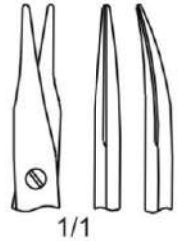
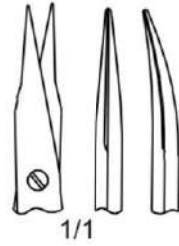

05-0901	10.5 cm	Straight	Sharp
05-0911	10.5 cm	Curved	Sharp

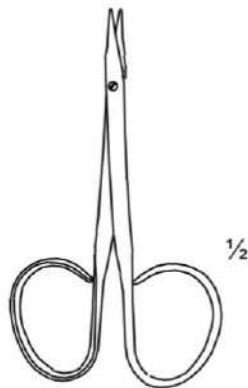

**STEVENS**  
Flat shanks and  
large ergonomical rings

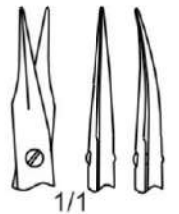
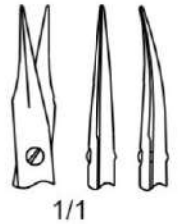

05-0902	10.5 cm	Straight	Sharp
05-0912	10.5 cm	Curved	Sharp

05-1002	10.5 cm	Straight	Blunt
05-1012	10.5 cm	Curved	Blunt



**FINE**

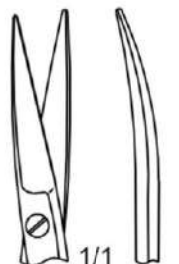
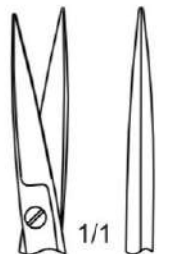

05-1301	9.0 cm	Straight	Sharp/Sharp
05-1302	10.0 cm	Straight	Sharp/Sharp
05-1303	11.5 cm	Straight	Sharp/Sharp

05-1311	9.0 cm	Curved	Sharp/Sharp
05-1312	10.0 cm	Curved	Sharp/Sharp
05-1313	11.5 cm	Curved	Sharp/Sharp



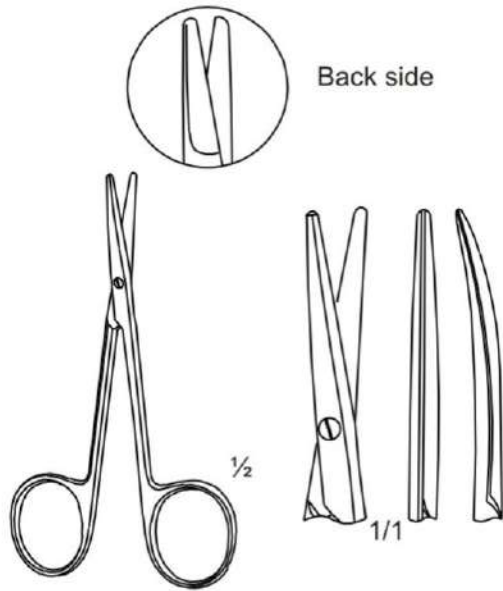

**STRABISMUS**

05-1401	11.0 cm	Straight
05-1411	11.0 cm	Curved

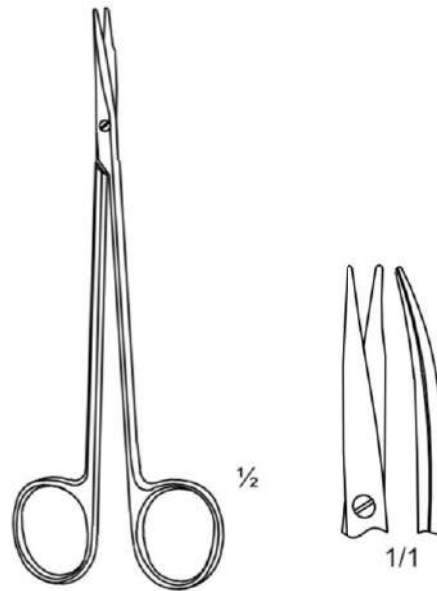

**JAMESON**

05-1501	14.5 cm	
05-1502	14.5 cm	Fine tips

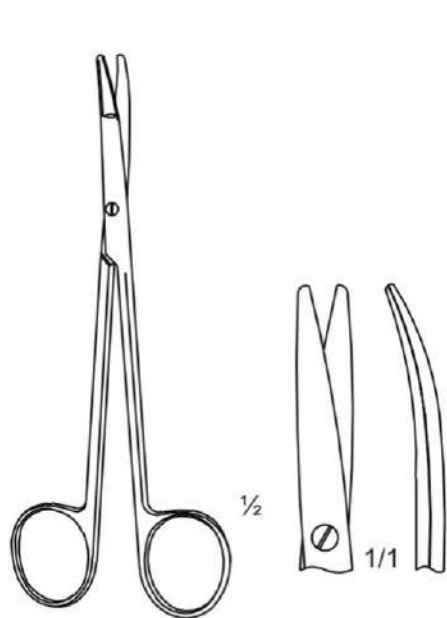

**KILNER**

Special flat points for dissecting and undermining skin

05-1601	12.0 cm	Curved
05-1602	13.0 cm	Curved
05-1603	15.0 cm	Curved

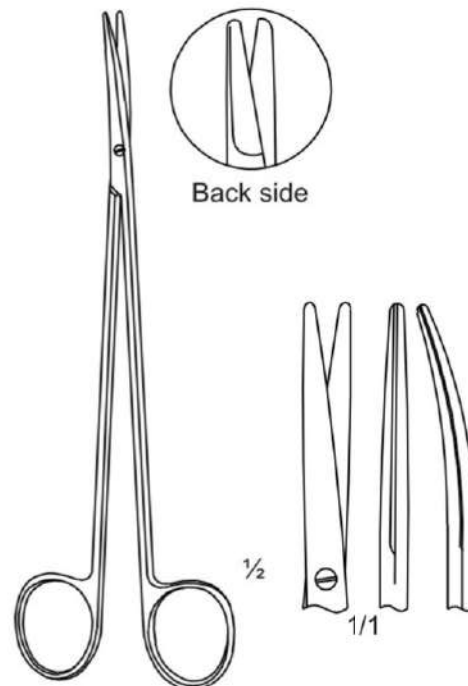

**TOENNIS-ADSON**  
Very delicate pattern

05-1810	18.0 cm	Straight
05-1820	18.0 cm	Curved

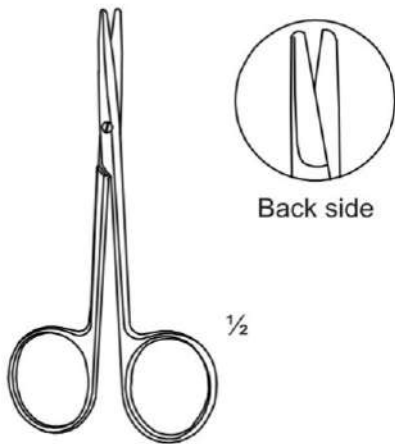

Back side

1/2

**METZERNBAUM-BABY**

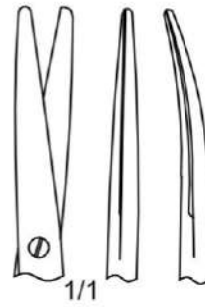

1/1

05-1901	11.0 cm	Straight
05-1911	11.0 cm	Curved

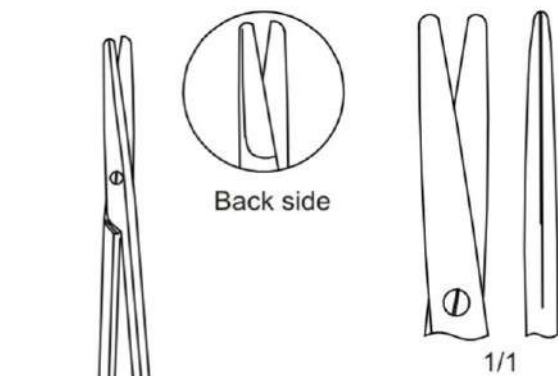

Back side

1/2

**METZERNBAUM**  
Standard pattern

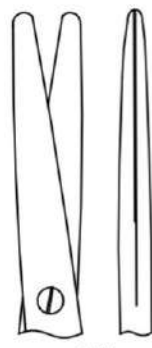

1/1

05-1902	14.0 cm	Straight	Blunt/Blunt
05-1903	18.0 cm	Straight	Blunt/Blunt
05-1904	20.0 cm	Straight	Blunt/Blunt
05-1905	23.0 cm	Straight	Blunt/Blunt
05-1906	25.0 cm	Straight	Blunt/Blunt
05-1907	28.0 cm	Straight	Blunt/Blunt
05-1908	30.5 cm	Straight	Blunt/Blunt

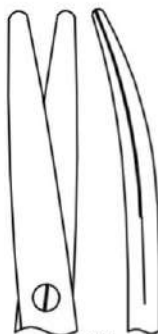

1/1

05-1912	14.0 cm	Curved	Blunt/Blunt
05-1913	18.0 cm	Curved	Blunt/Blunt
05-1914	20.0 cm	Curved	Blunt/Blunt
05-1915	23.0 cm	Curved	Blunt/Blunt
05-1916	25.0 cm	Curved	Blunt/Blunt
05-1917	28.0 cm	Curved	Blunt/Blunt
05-1918	30.5 cm	Curved	Blunt/Blunt

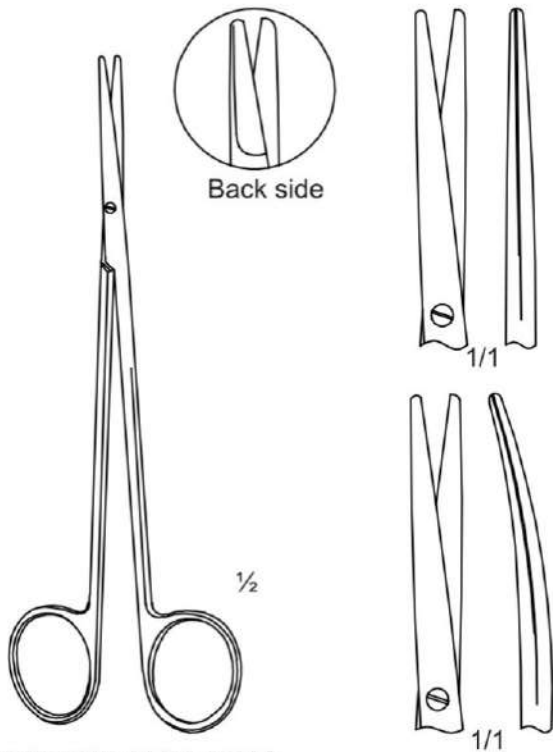

**METZENBAUM-FINO**  
Delicate pattern

05-2001	14.0 cm	Straight	Blunt/Blunt
05-2002	18.0 cm	Straight	Blunt/Blunt
05-2003	20.0 cm	Straight	Blunt/Blunt
05-2004	23.0 cm	Straight	Blunt/Blunt
05-2005	25.0 cm	Straight	Blunt/Blunt
05-2006	28.0 cm	Straight	Blunt/Blunt

05-2011	14.0 cm	Curved	Blunt/Blunt
05-2012	18.0 cm	Curved	Blunt/Blunt
05-2013	20.0 cm	Curved	Blunt/Blunt
05-2014	23.0 cm	Curved	Blunt/Blunt
05-2015	25.0 cm	Curved	Blunt/Blunt
05-2016	28.0 cm	Curved	Blunt/Blunt

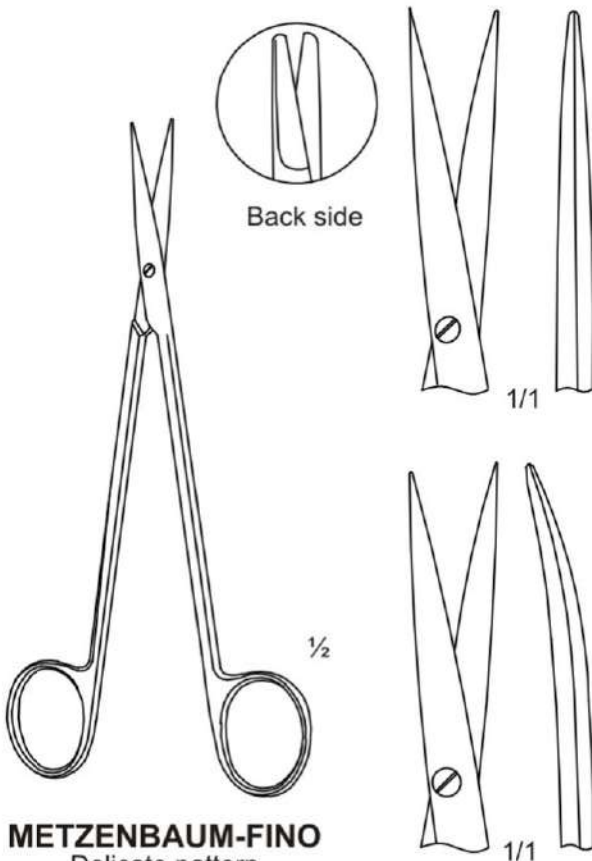

**METZENBAUM-FINO**  
Delicate pattern

05-2101	14.0 cm	Straight	Sharp/Sharp
05-2102	18.0 cm	Straight	Sharp/Sharp
05-2103	20.0 cm	Straight	Sharp/Sharp
05-2104	23.0 cm	Straight	Sharp/Sharp
05-2105	25.0 cm	Straight	Sharp/Sharp
05-2106	28.0 cm	Straight	Sharp/Sharp

05-2111	14.0 cm	Curved	Sharp/Sharp
05-2112	18.0 cm	Curved	Sharp/Sharp
05-2113	20.0 cm	Curved	Sharp/Sharp
05-2114	23.0 cm	Curved	Sharp/Sharp
05-2115	25.0 cm	Curved	Sharp/Sharp
05-2116	28.0 cm	Curved	Sharp/Sharp



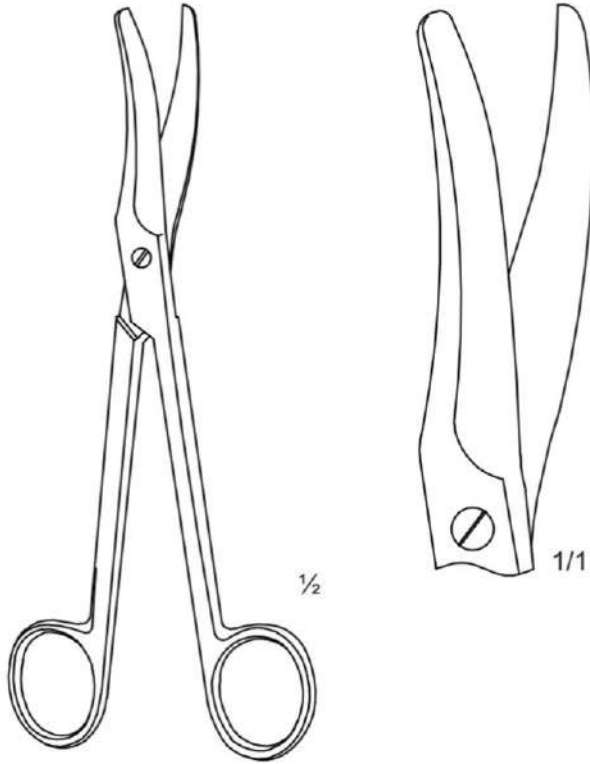

**EPISIOTOMY**

05-2300 | 19.0 cm

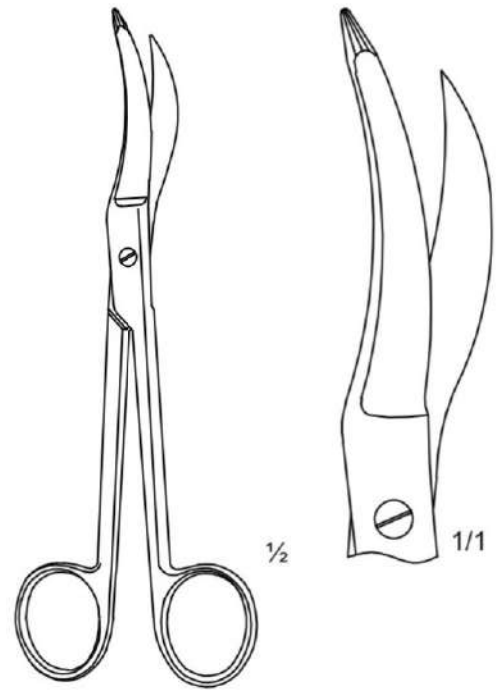

**WALDMANN**

05-2400 | 19.0 cm

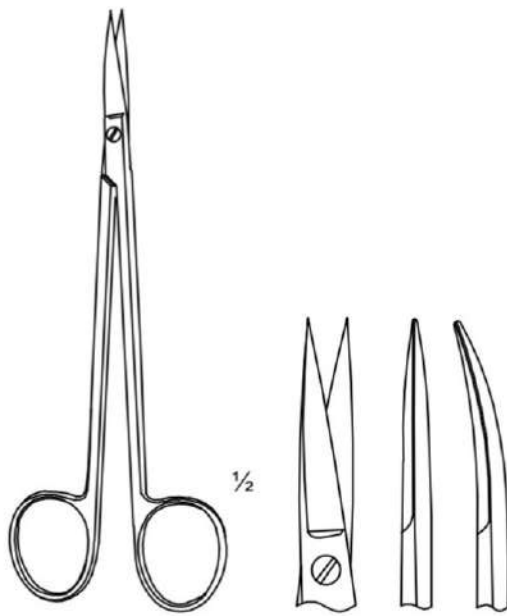

**KELLY**

05-2701 | 16.0 cm | Straight  
05-2711 | 16.0 cm | Curved

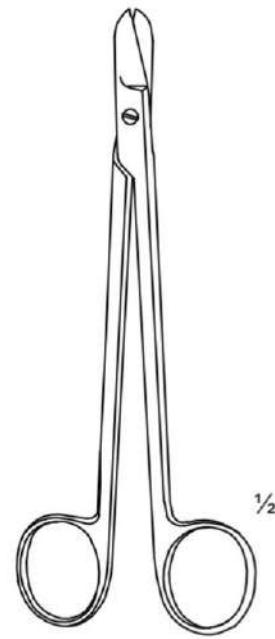

**SMITH**

Wire Cutting

05-3001 | 16.0 cm

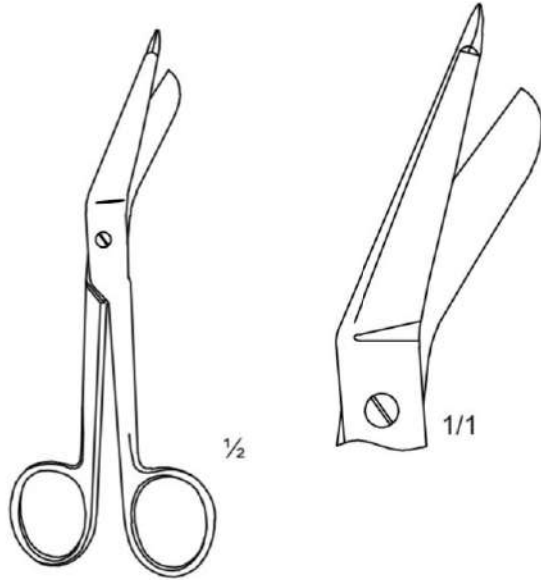

**LISTER**

05-3101	14.0 cm
05-3102	18.0 cm
05-3103	20.0 cm

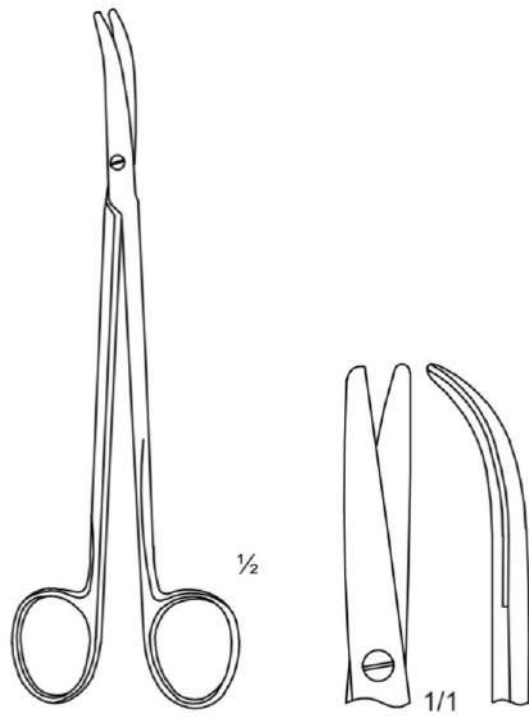

**HALLE**  
Nasal Scissors

05-3200	19.0 cm
---------	---------

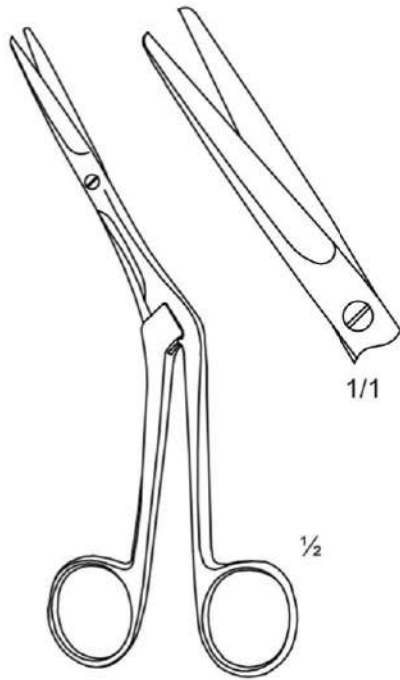

**HEYMANN-KNIGHT**  
Nasal Scissors

05-3201 | 18.0 cm | Blunt

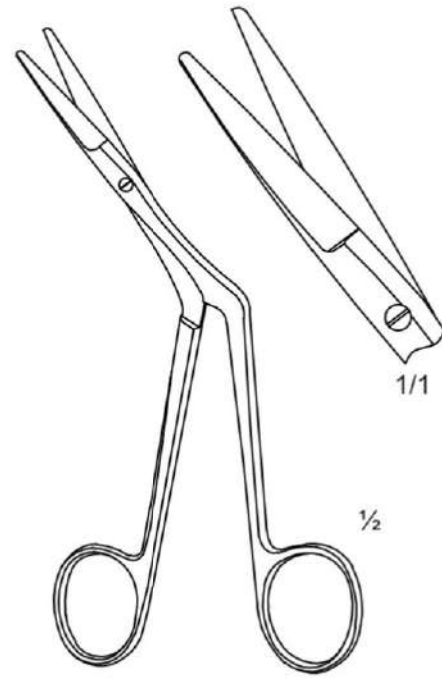

**HEYMANN**  
Nasal Scissors

05-3202 | 18.0 cm | Blunt

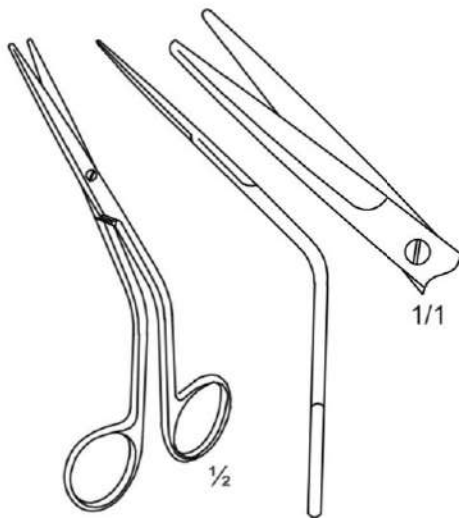

**FOMON**  
Nasal Scissors

05-3203 | 14.0 cm | Blunt

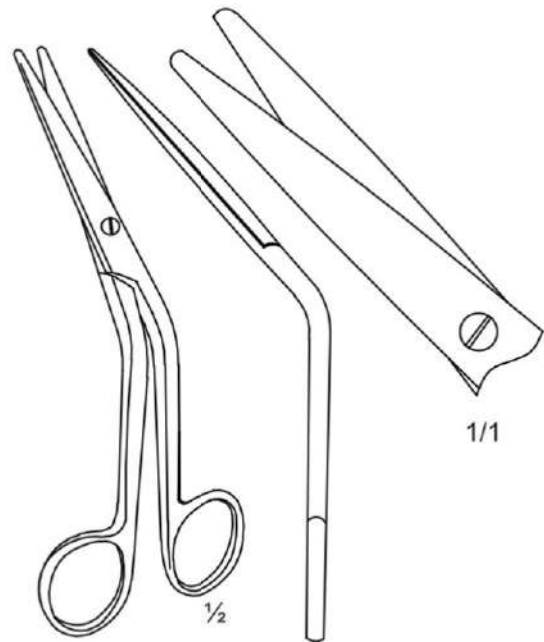

**COTTLE**  
Nasal Scissors

05-3204 | 16.0 cm | Blunt

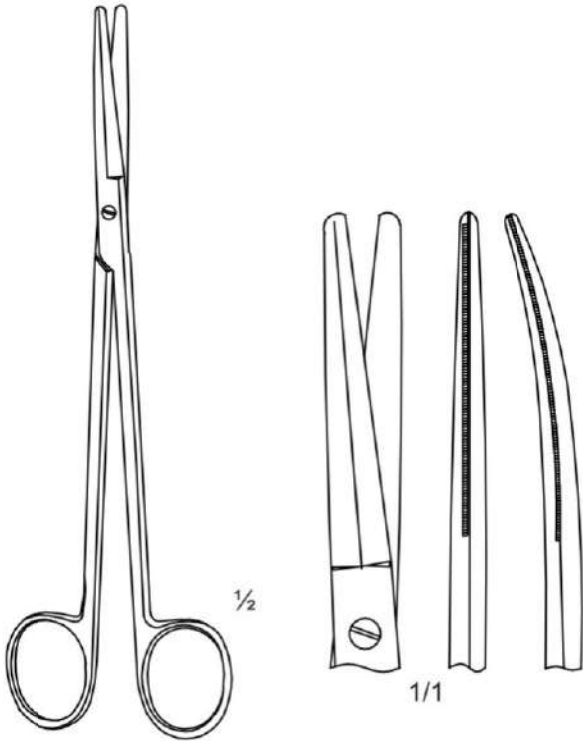

**GORNEY**  
Dissecting Scissors

05-3301	19.0 cm	Straight
05-3311	19.0 cm	Curved

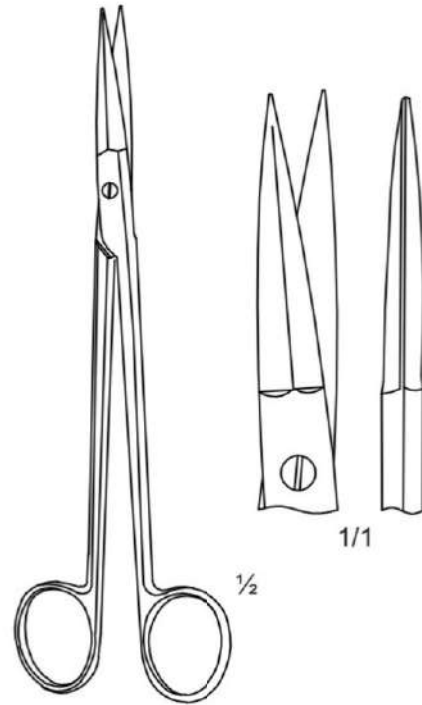

**MC INDOE**

05-3400	19.0 cm	Straight
---------	---------	----------

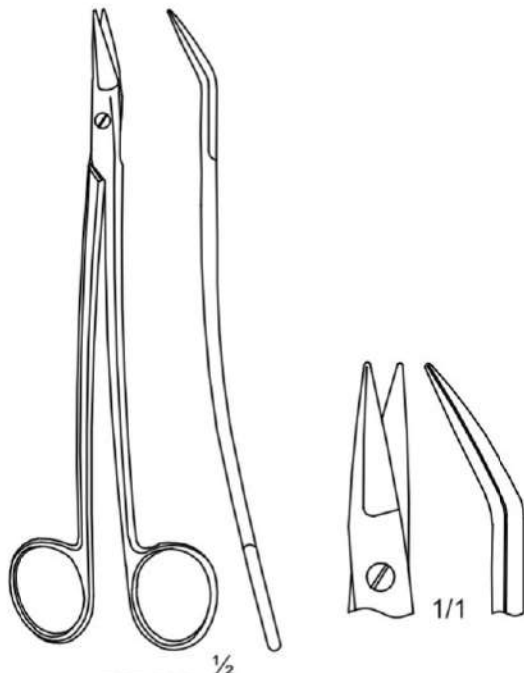

**DEAN**  
Curved on flat

05-3501	15.0 cm
05-3502	17.0 cm

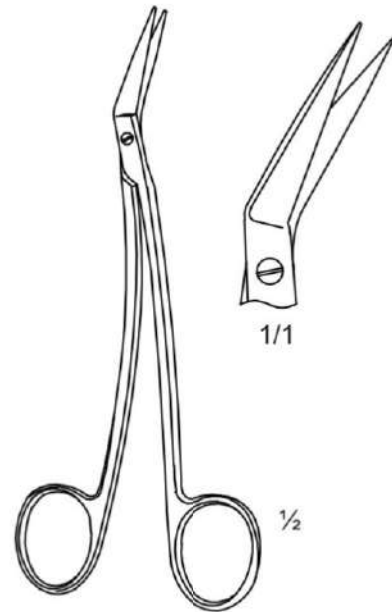

**LOCKLIN**  
Curved to side

05-3600	16.5 cm
---------	---------



25°

1/1

05-3701



45°

1/1

05-3702



60°

1/1

05-3703



90°

1/1

05-3704



125°

1/1

05-3705

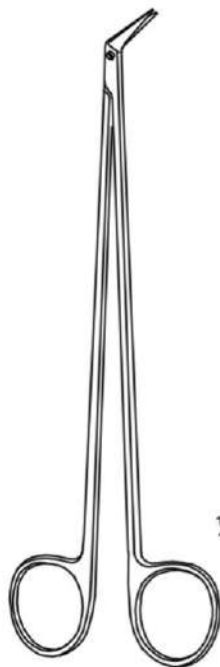

1/2

**HEGEMANN**  
Curved to side



25°

1/1

05-3801



45°

1/1

05-3802



60°

1/1

05-3803



125°

1/1

05-3804

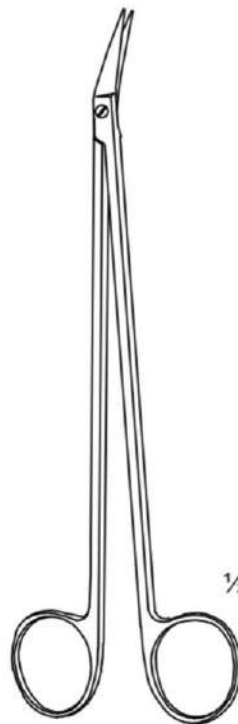

1/2

**POTTS-SMITH**  
Curved to side



1/1

05-3901

17.0 cm

05-3902

19.5 cm

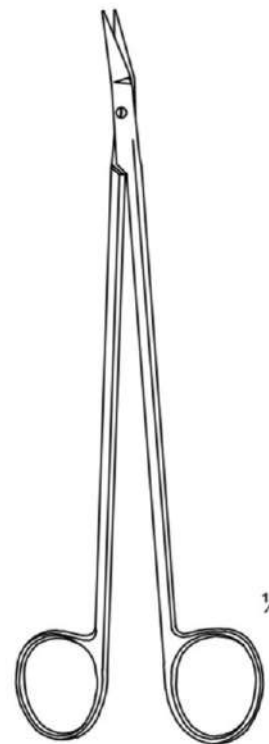

1/2

**POTTS-SMITH**  
Curved on flat

# Surgical Scissors TC

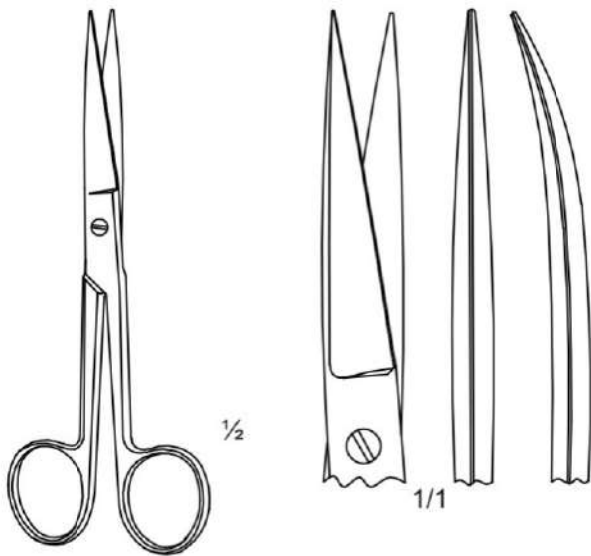

**OPERATING**

06-0101	14.0 cm	Straight	Sharp/Sharp
06-0102	17.0 cm	Straight	Sharp/Sharp
06-0111	14.0 cm	Curved	Sharp/Sharp
06-0112	17.0 cm	Curved	Sharp/Sharp

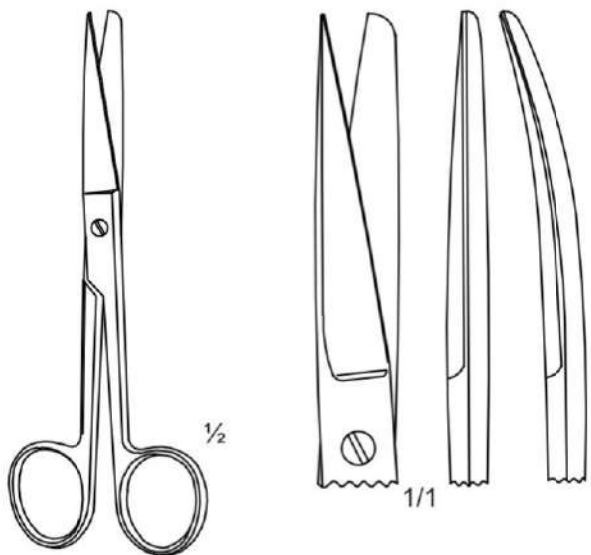

**OPERATING**

06-0201	14.0 cm	Straight	Sharp/Blunt
06-0202	17.0 cm	Straight	Sharp/Blunt
06-0211	14.0 cm	Curved	Sharp/Blunt
06-0212	17.0 cm	Curved	Sharp/Blunt

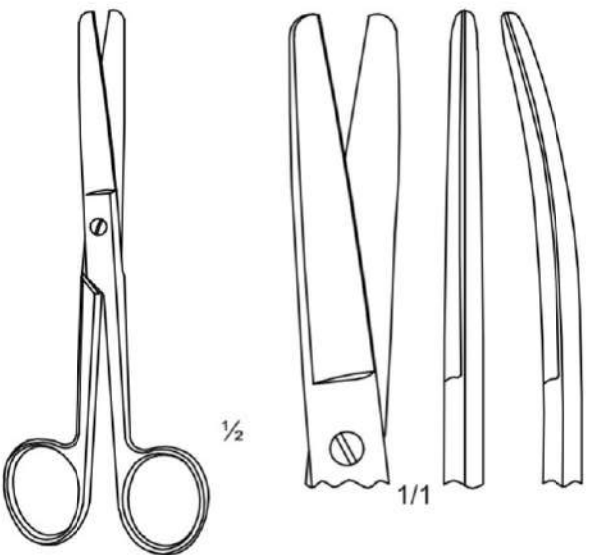

**OPERATING**

06-0301	14.0 cm	Straight	Blunt/Blunt
06-0302	17.0 cm	Straight	Blunt/Blunt
06-0311	14.0 cm	Curved	Blunt/Blunt
06-0312	17.0 cm	Curved	Blunt/Blunt



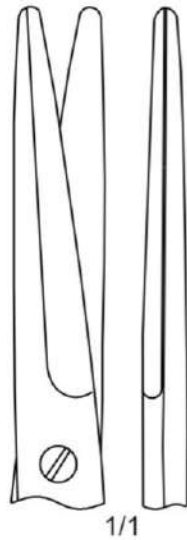
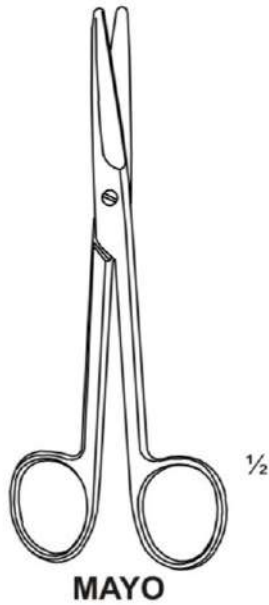

06-0401	14.5 cm	Straight
06-0402	17.0 cm	Straight
06-0403	20.0 cm	Straight
06-0404	23.0 cm	Straight
06-0405	28.0 cm	Straight



06-0411	14.5 cm	Curved
06-0412	17.0 cm	Curved
06-0413	20.0 cm	Curved
06-0414	23.0 cm	Curved
06-0415	28.0 cm	Curved

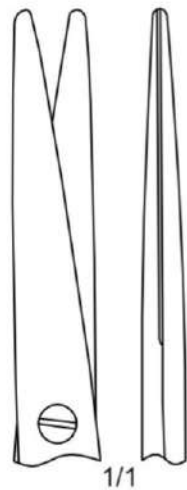
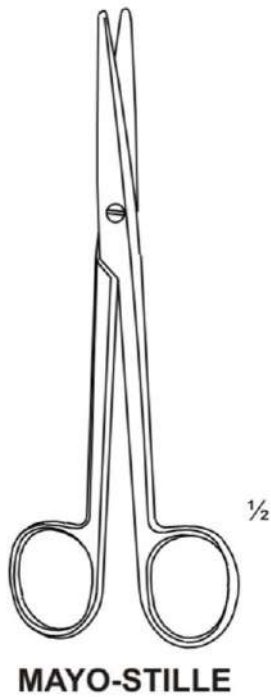

06-0501	15.0 cm	Straight
06-0502	17.0 cm	Straight
06-0503	19.0 cm	Straight
06-0504	21.0 cm	Straight
06-0505	23.0 cm	Straight



06-0511	15.0 cm	Curved
06-0512	17.0 cm	Curved
06-0513	19.0 cm	Curved
06-0514	21.0 cm	Curved
06-0515	23.0 cm	Curved

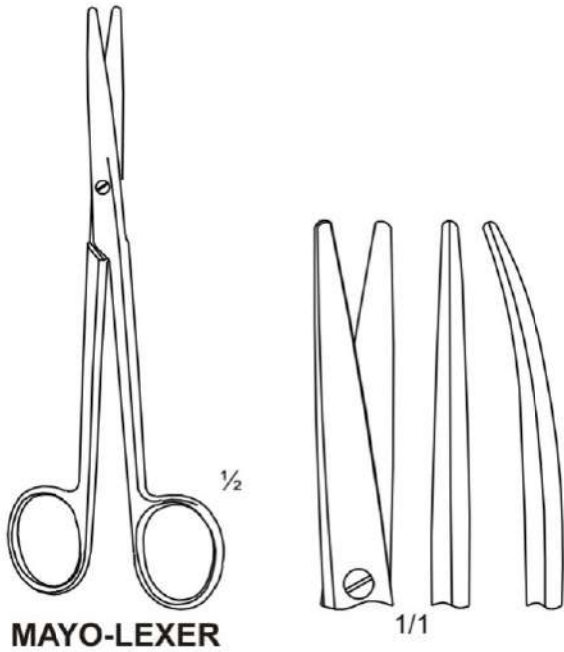

06-0601	16.0 cm	Straight
06-0602	21.0 cm	Straight
06-0611	16.0 cm	Curved
06-0612	21.0 cm	Curved

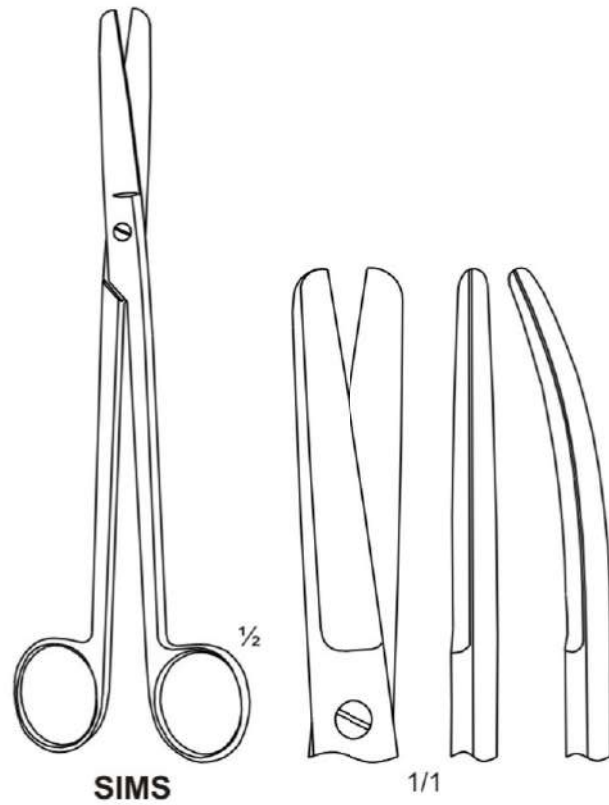

06-0701	20.0 cm	Straight
06-0702	23.0 cm	Straight
06-0711	20.0 cm	Curved
06-0712	23.0 cm	Curved

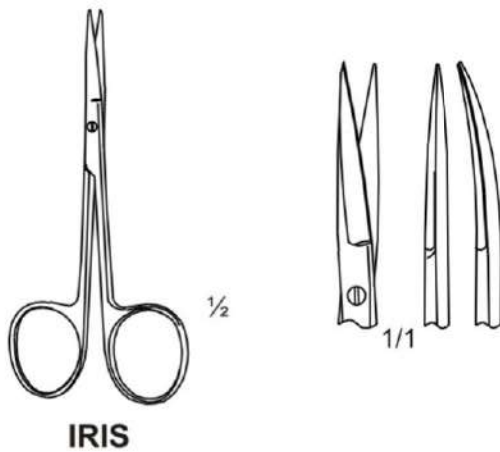

06-0801	10.0 cm	Straight
06-0802	11.0 cm	Straight
06-0811	10.0 cm	Curved
06-0812	11.0 cm	Curved



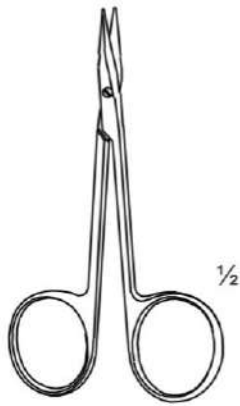

**STEVENS**  
Vessel-and tendon  
scissors

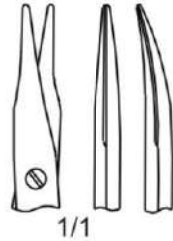
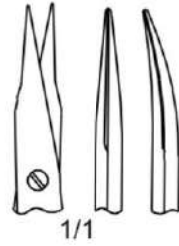

06-0901	10.5 cm	Straight	Sharp
06-0911	10.5 cm	Curved	Sharp

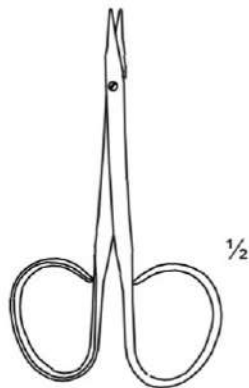

**STEVENS**  
Flat shanks and  
large ergonomic rings

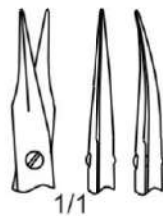
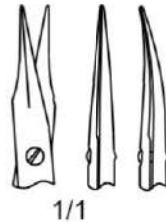

06-0902	10.5 cm	Straight	Sharp
06-0912	10.5 cm	Curved	Sharp

06-1002	10.5 cm	Straight	Blunt
06-1012	10.5 cm	Curved	Blunt

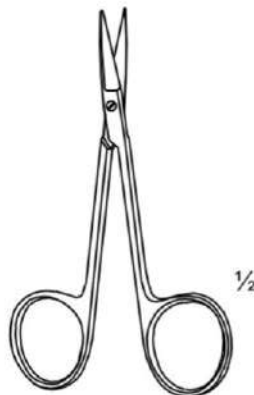

**FINE**



06-1301	9.0 cm	Straight	Sharp/Sharp
06-1302	10.0 cm	Straight	Sharp/Sharp
06-1303	11.5 cm	Straight	Sharp/Sharp

06-1311	9.0 cm	Curved	Sharp/Sharp
06-1312	10.0 cm	Curved	Sharp/Sharp
06-1313	11.5 cm	Curved	Sharp/Sharp

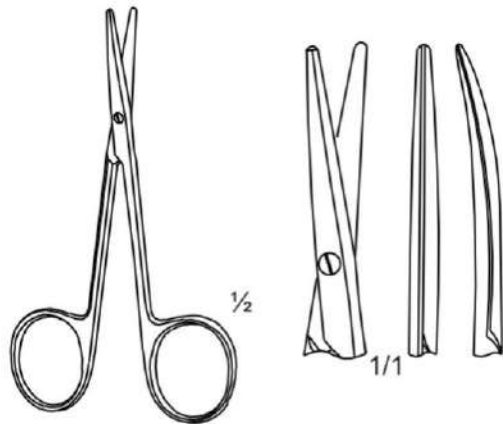

**STRABISMUS**

06-1401	11.0 cm	Straight
06-1411	11.0 cm	Curved

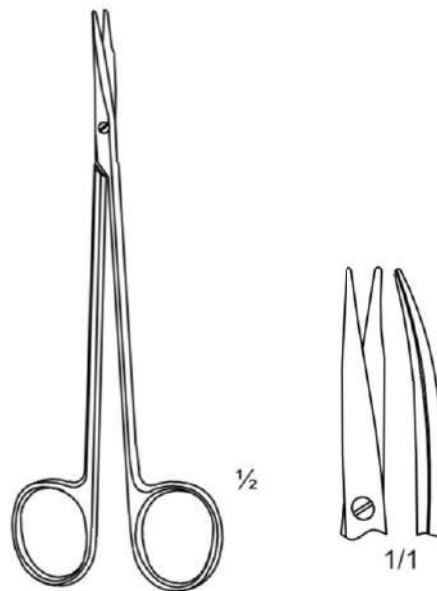

**JAMESON**

06-1501	14.5 cm	
06-1502	14.5 cm	Fine tips

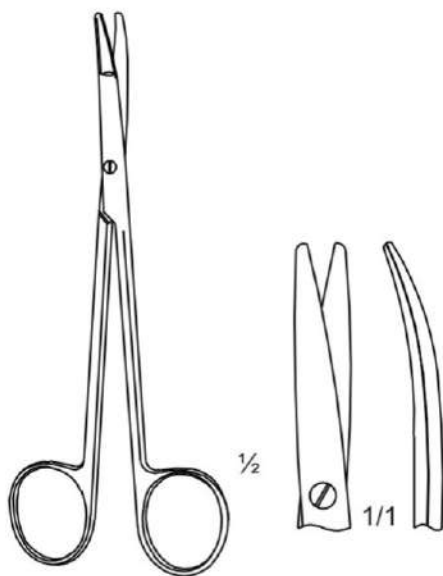

**KILNER**

Special flat points for dissecting and undermining skin

06-1601	12.0 cm	Curved
06-1602	13.0 cm	Curved
06-1603	15.0 cm	Curved

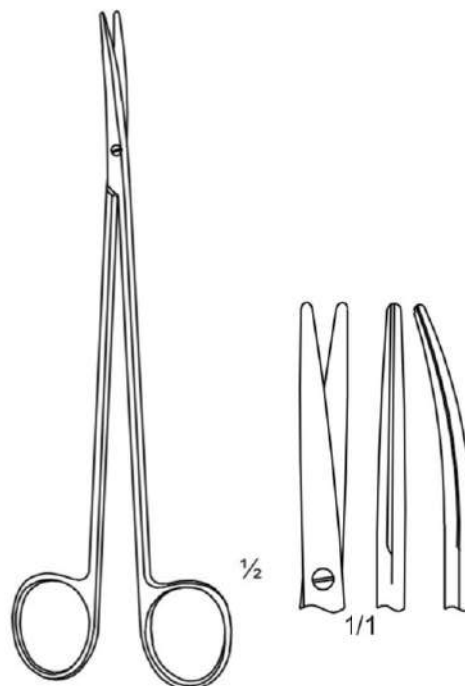

**TOENNIS-ADSON**

Very delicate pattern

06-1810	18.0 cm	Straight
06-1820	18.0 cm	Curved

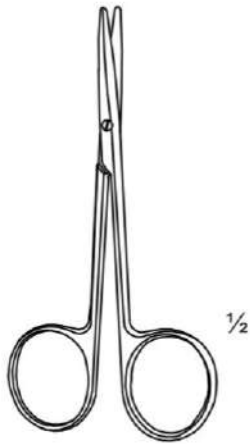

**METZEBNBAUM-BABY**

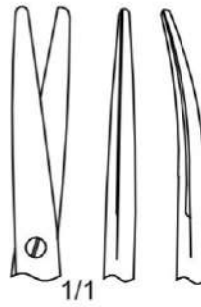

06-1901	11.0 cm	Straight
06-1911	11.0 cm	Curved

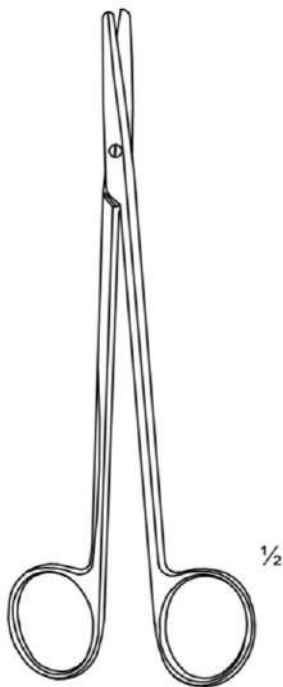

**METZENBAUM**  
Standard pattern

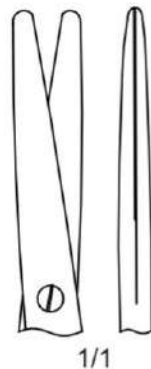

06-1902	14.0 cm	Straight	Blunt/Blunt
06-1903	18.0 cm	Straight	Blunt/Blunt
06-1904	20.0 cm	Straight	Blunt/Blunt
06-1905	23.0 cm	Straight	Blunt/Blunt
06-1906	25.0 cm	Straight	Blunt/Blunt
06-1907	28.0 cm	Straight	Blunt/Blunt
06-1908	30.5 cm	Straight	Blunt/Blunt

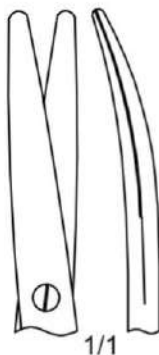

06-1912	14.0 cm	Curved	Blunt/Blunt
06-1913	18.0 cm	Curved	Blunt/Blunt
06-1914	20.0 cm	Curved	Blunt/Blunt
06-1915	23.0 cm	Curved	Blunt/Blunt
06-1916	25.0 cm	Curved	Blunt/Blunt
06-1917	28.0 cm	Curved	Blunt/Blunt
06-1918	30.5 cm	Curved	Blunt/Blunt

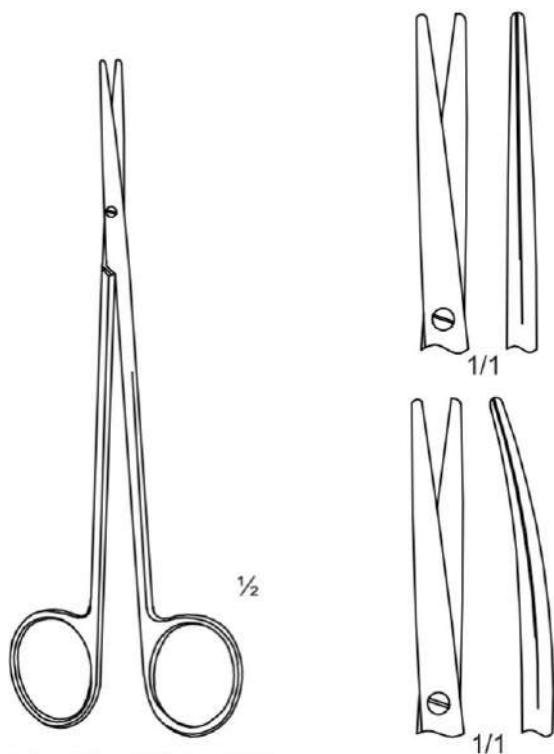

**METZENBAUM-FINO**  
Delicate pattern

06-2001	14.0 cm	Straight	Blunt/Blunt
06-2002	18.0 cm	Straight	Blunt/Blunt
06-2003	20.0 cm	Straight	Blunt/Blunt
06-2004	23.0 cm	Straight	Blunt/Blunt
06-2005	25.0 cm	Straight	Blunt/Blunt
06-2006	28.0 cm	Straight	Blunt/Blunt

06-2011	14.0 cm	Curved	Blunt/Blunt
06-2012	18.0 cm	Curved	Blunt/Blunt
06-2013	20.0 cm	Curved	Blunt/Blunt
06-2014	23.0 cm	Curved	Blunt/Blunt
06-2015	25.0 cm	Curved	Blunt/Blunt
06-2016	28.0 cm	Curved	Blunt/Blunt

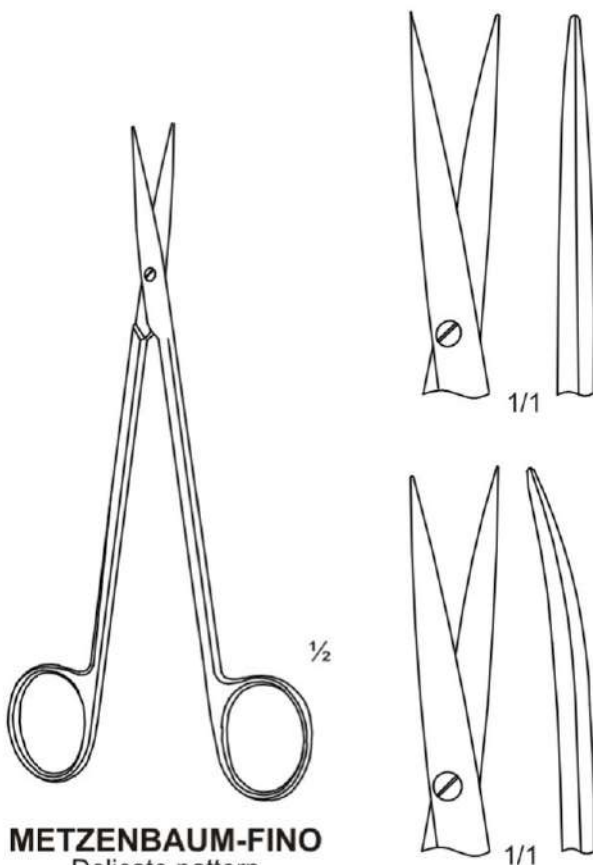

**METZENBAUM-FINO**  
Delicate pattern

06-2101	14.0 cm	Straight	Sharp/Sharp
06-2102	18.0 cm	Straight	Sharp/Sharp
06-2103	20.0 cm	Straight	Sharp/Sharp
06-2104	23.0 cm	Straight	Sharp/Sharp
06-2105	25.0 cm	Straight	Sharp/Sharp
06-2106	28.0 cm	Straight	Sharp/Sharp

06-2111	14.0 cm	Curved	Sharp/Sharp
06-2112	18.0 cm	Curved	Sharp/Sharp
06-2113	20.0 cm	Curved	Sharp/Sharp
06-2114	23.0 cm	Curved	Sharp/Sharp
06-2115	25.0 cm	Curved	Sharp/Sharp
06-2116	28.0 cm	Curved	Sharp/Sharp

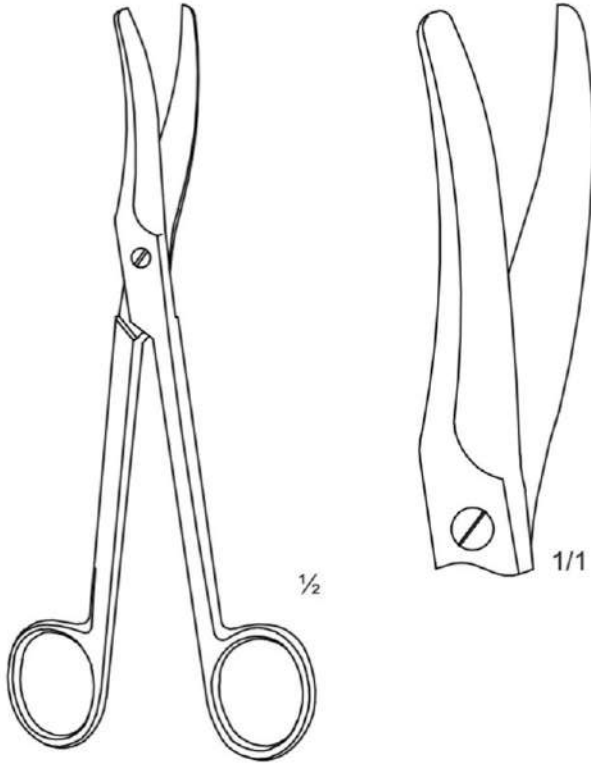

**EPISIOTOMY**

06-2300 | 19.0 cm

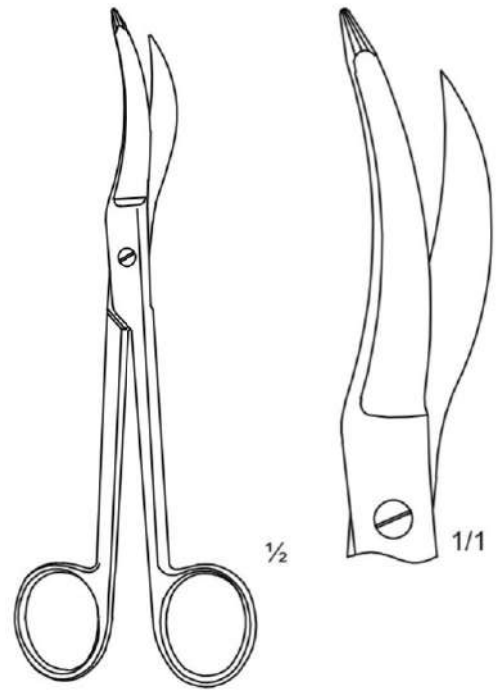

**WALDMANN**

06-2400 | 19.0 cm

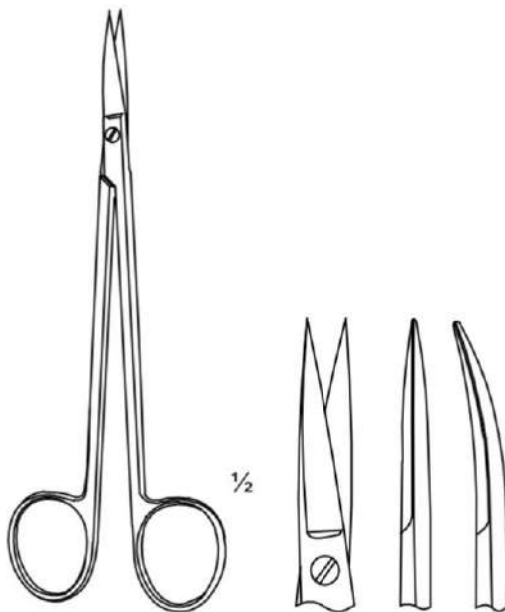

**KELLY**

06-2701	16.0 cm	Straight
06-2711	16.0 cm	Curved



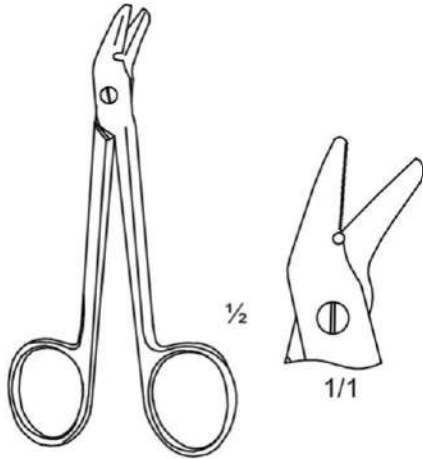

**UNIVERSAL**  
Wire Cutting

06-3000 12.0 cm Curved

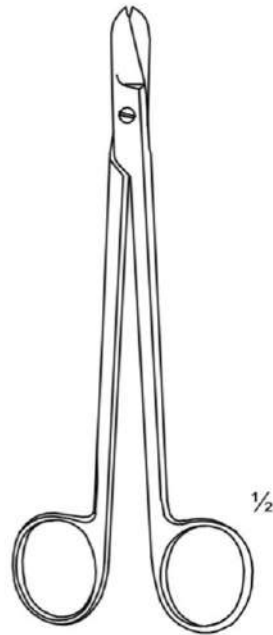

**SMITH**  
Wire Cutting

06-3001 16.0 cm

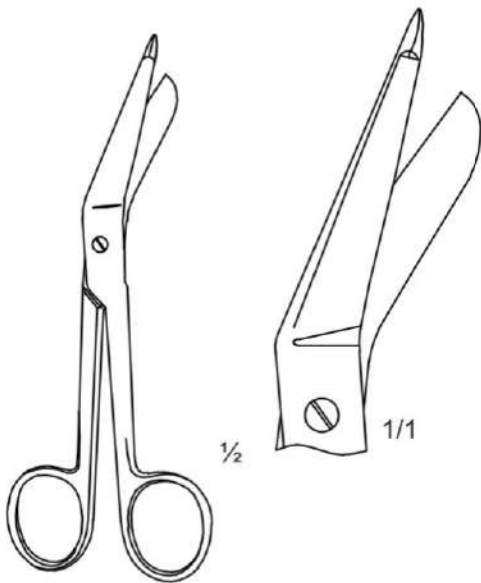

**LISTER**

06-3101 14.0 cm  
06-3102 18.0 cm  
06-3103 20.0 cm

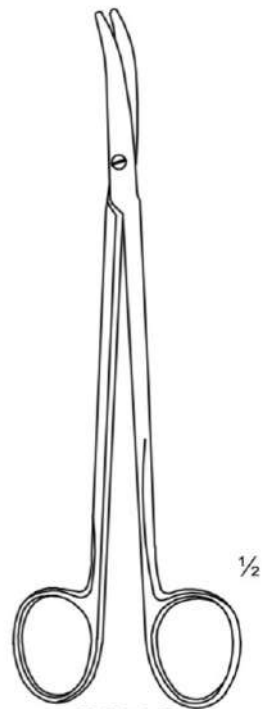

**HALLE**  
Nasal Scissors

06-3200 19.0 cm

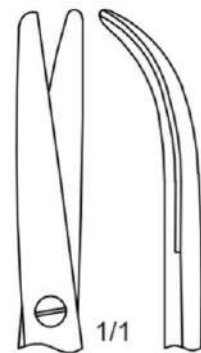

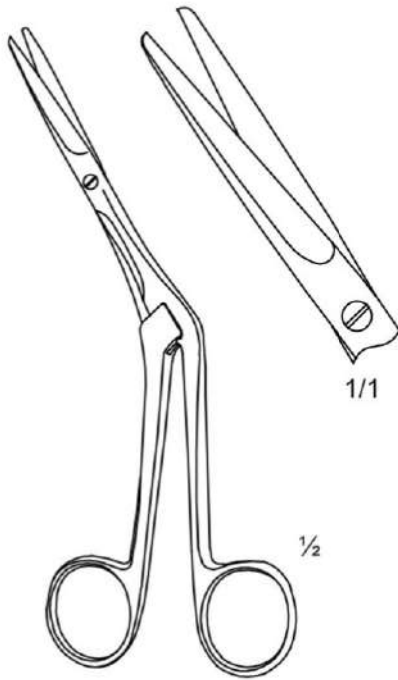

**HEYMANN-KNIGHT**  
Nasal Scissors

06-3201 | 18.0 cm | Blunt

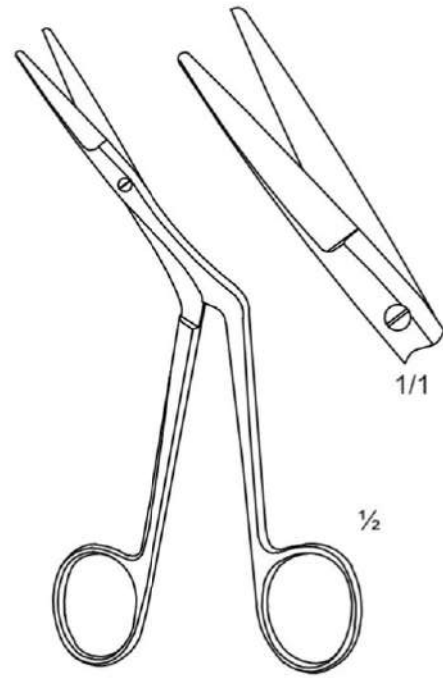

**HEYMANN**  
Nasal Scissors

06-3202 | 18.0 cm | Blunt

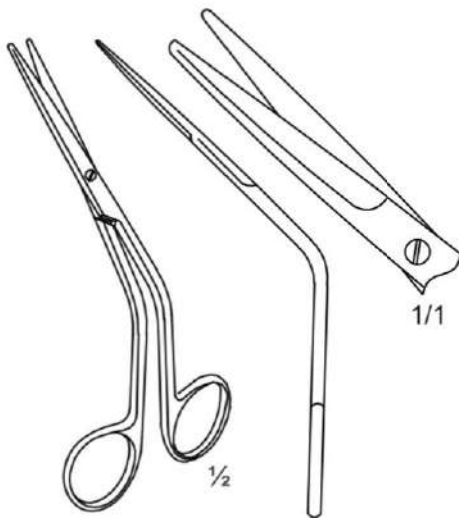

**FOMON**  
Nasal Scissors

06-3203 | 14.0 cm | Blunt

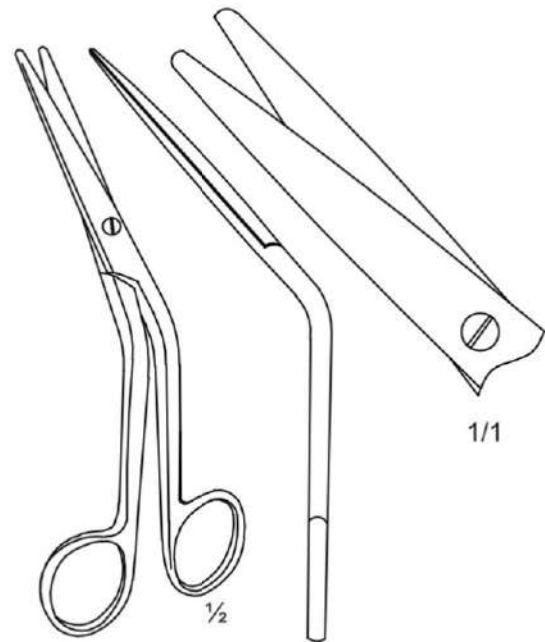

**COTTLE**  
Nasal Scissors

06-3204 | 16.0 cm | Blunt

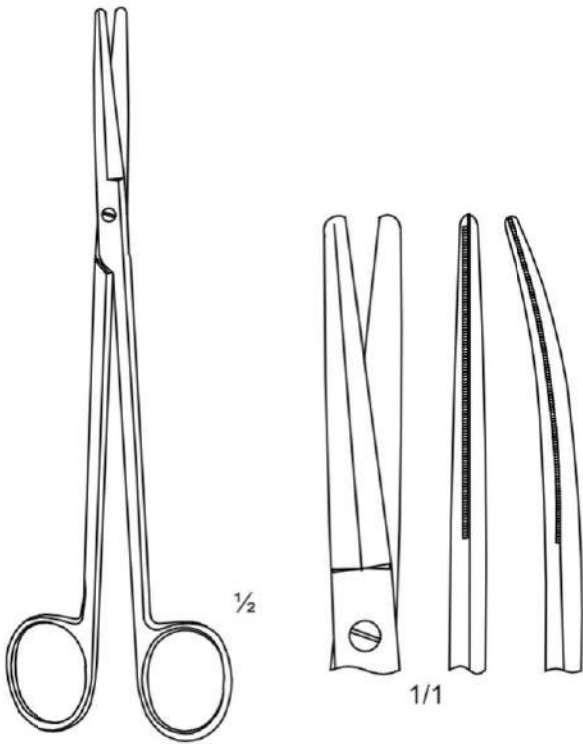

**GORNEY**  
Dissecting Scissors

06-3301	19.0 cm	Straight
06-3311	19.0 cm	Curved

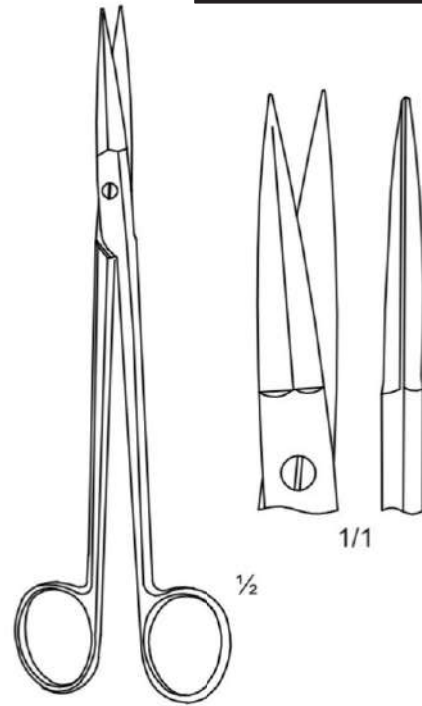

**MC INDOE**

06-3400	19.0 cm	Straight
---------	---------	----------

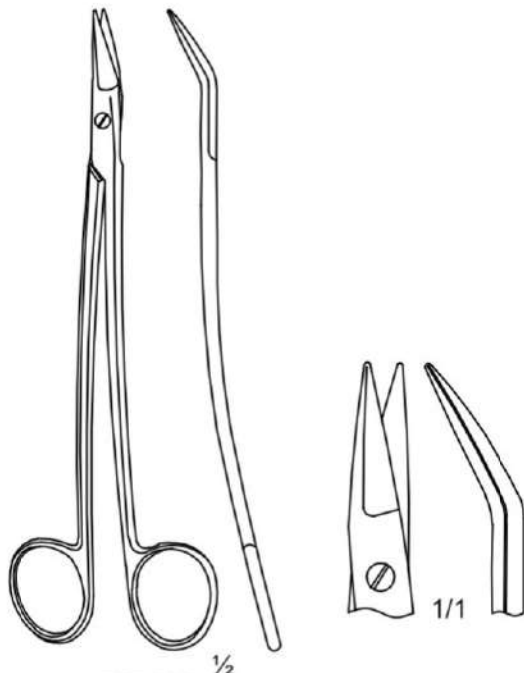

**DEAN**  
Curved on flat

06-3501	15.0 cm
06-3502	17.0 cm

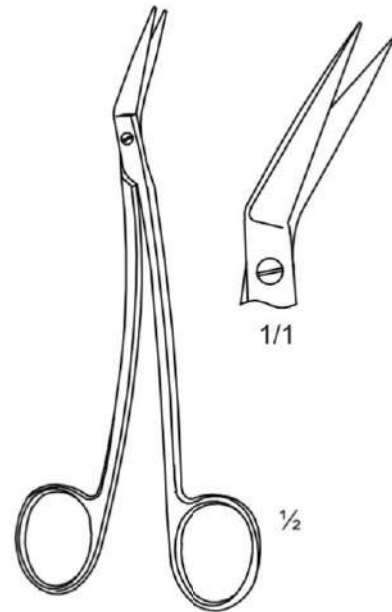

**LOCKLIN**  
Curved to side

06-3600	16.5 cm
---------	---------





25°

1/1

06-3701



45°

1/1

06-3702



60°

1/1

06-3703

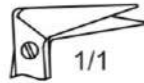

90°

1/1

06-3704



125°

1/1

06-3705

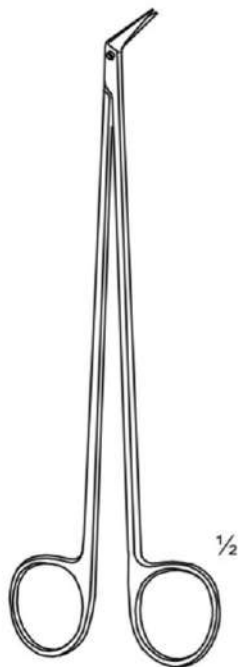

1/2

**HEGEMANN**  
Curved to side



25°

1/1

06-3801



45°

1/1

06-3802



60°

1/1

06-3803

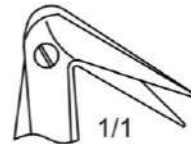

1/1

06-3804

125°

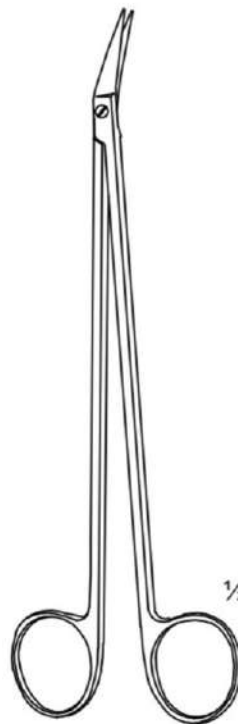

1/2

**POTTS-SMITH**  
Curved to side



1/1

06-3901

17.0 cm

06-3902

19.5 cm

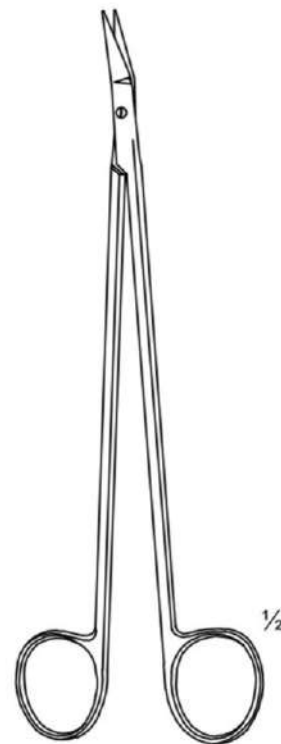

1/2

**POTTS-SMITH**  
Curved on flat

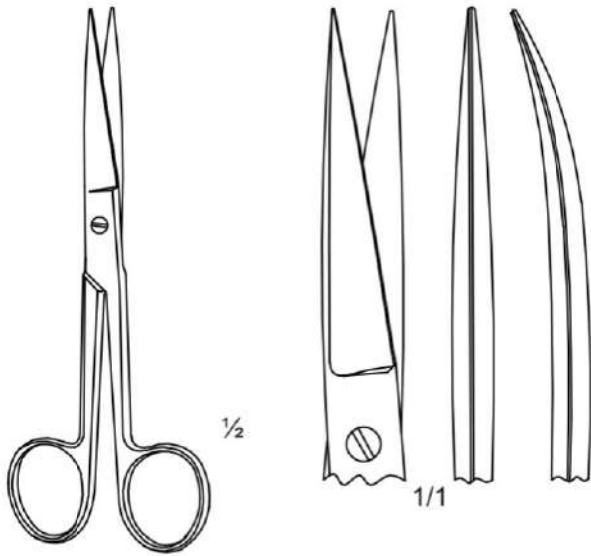

OPERATING

07-0101	14.0 cm	Straight	Sharp/Sharp
07-0102	17.0 cm	Straight	Sharp/Sharp
07-0111	14.0 cm	Curved	Sharp/Sharp
07-0112	17.0 cm	Curved	Sharp/Sharp

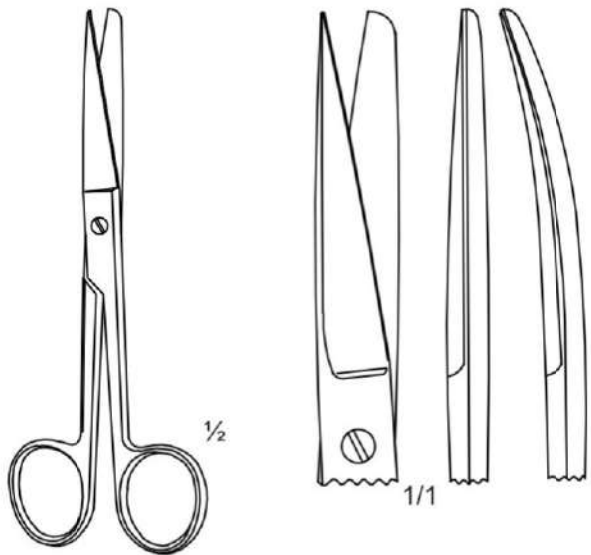

OPERATING

07-0201	14.0 cm	Straight	Sharp/Blunt
07-0202	17.0 cm	Straight	Sharp/Blunt
07-0211	14.0 cm	Curved	Sharp/Blunt
07-0212	17.0 cm	Curved	Sharp/Blunt

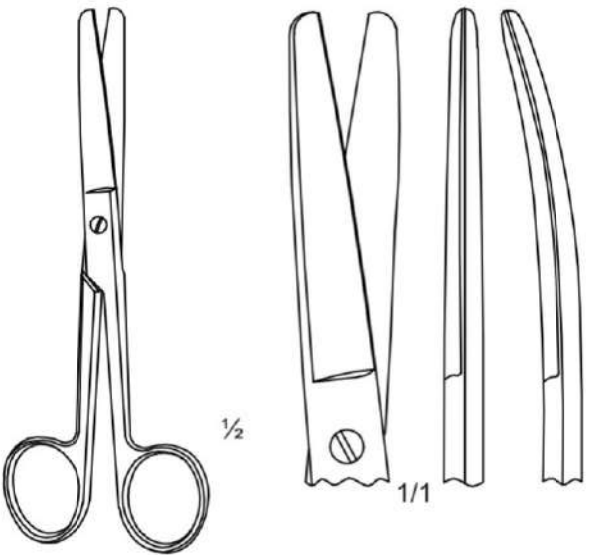

OPERATING

07-0301	14.0 cm	Straight	Blunt/Blunt
07-0302	17.0 cm	Straight	Blunt/Blunt
07-0311	14.0 cm	Curved	Blunt/Blunt
07-0312	17.0 cm	Curved	Blunt/Blunt

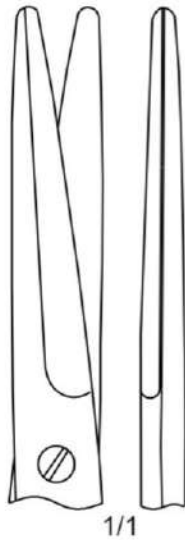
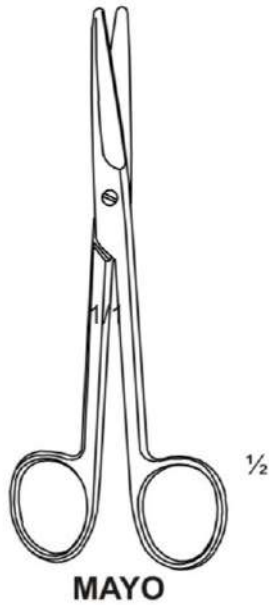

07-0401	14.5 cm	Straight
07-0402	17.0 cm	Straight
07-0403	20.0 cm	Straight
07-0404	23.0 cm	Straight
07-0405	28.0 cm	Straight



07-0411	14.5 cm	Curved
07-0412	17.0 cm	Curved
07-0413	20.0 cm	Curved
07-0414	23.0 cm	Curved
07-0415	28.0 cm	Curved

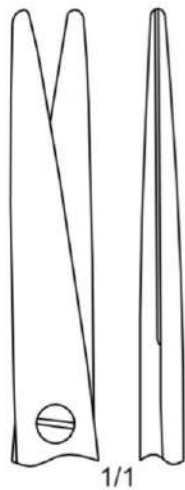
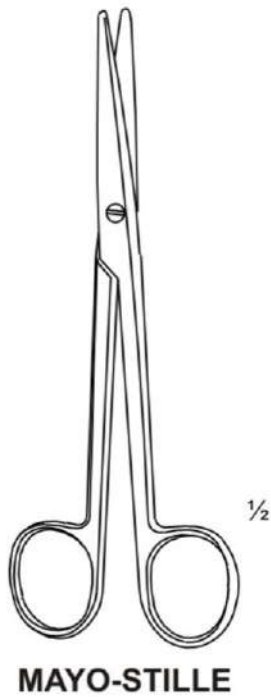

07-0501	15.0 cm	Straight
07-0502	17.0 cm	Straight
07-0503	19.0 cm	Straight
07-0504	21.0 cm	Straight
07-0505	23.0 cm	Straight

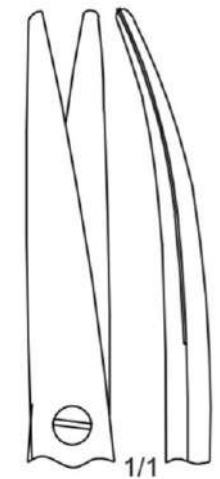

07-0511	15.0 cm	Curved
07-0512	17.0 cm	Curved
07-0513	19.0 cm	Curved
07-0514	21.0 cm	Curved
07-0515	23.0 cm	Curved

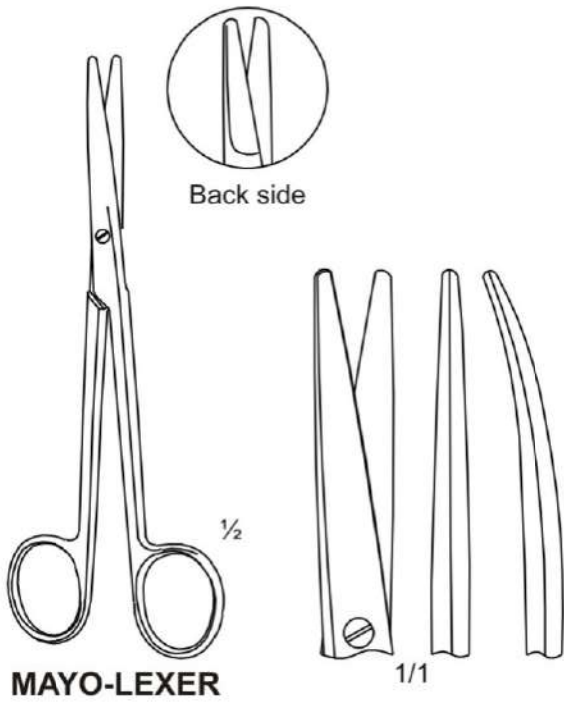

07-0601	16.0 cm	Straight
07-0602	21.0 cm	Straight
07-0611	16.0 cm	Curved
07-0612	21.0 cm	Curved

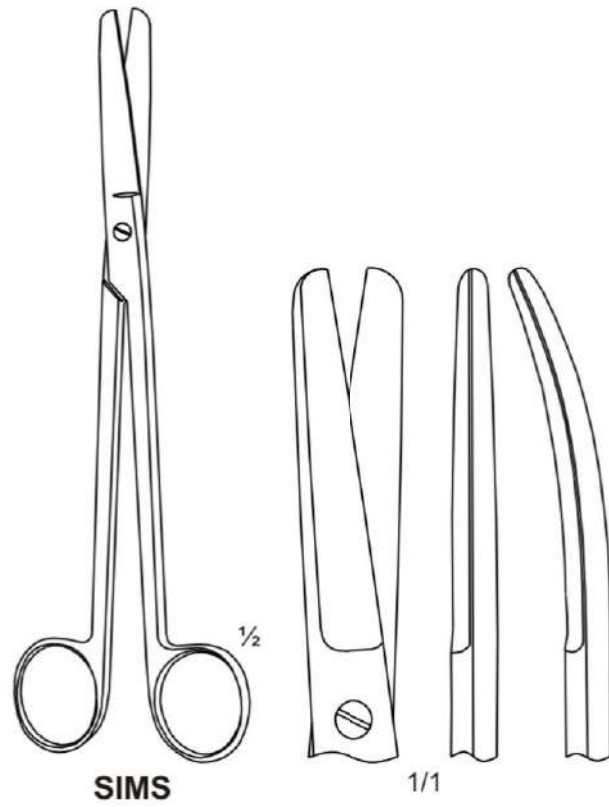

07-0701	20.0 cm	Straight
07-0702	23.0 cm	Straight
07-0711	20.0 cm	Curved
07-0712	23.0 cm	Curved

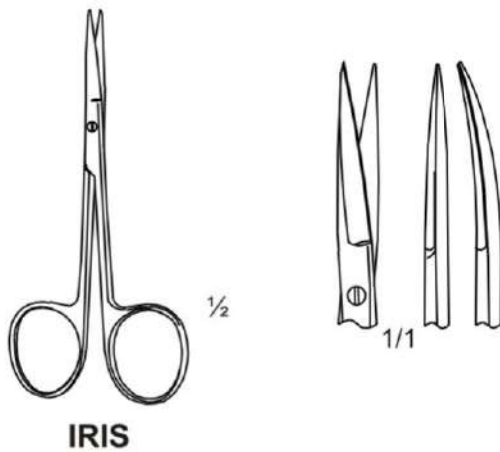

07-0801	10.0 cm	Straight
07-0802	11.0 cm	Straight
07-0811	10.0 cm	Curved
07-0812	11.0 cm	Curved

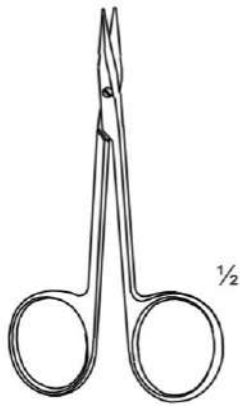

**STEVENS**  
Vessel-and tendon  
scissors

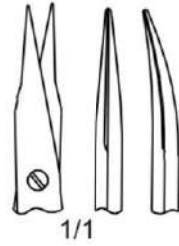

1/1

07-0901	10.5 cm	Straight	Sharp
07-0911	10.5 cm	Curved	Sharp

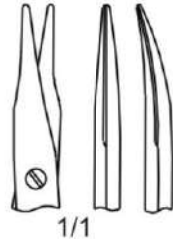

1/1

07-1001	10.5 cm	Straight	Blunt
07-1011	10.5 cm	Curved	Blunt

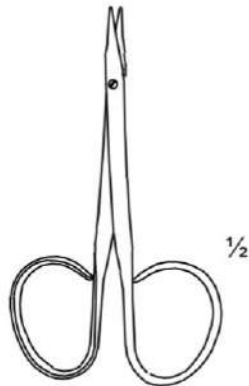

**STEVENS**  
Flat shanks and  
large ergonomic rings

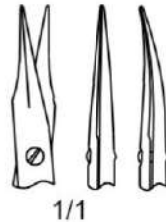

1/1

07-0902	10.5 cm	Straight	Sharp
07-0912	10.5 cm	Curved	Sharp

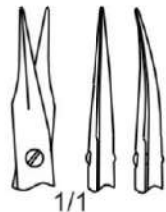

1/1

07-1002	10.5 cm	Straight	Blunt
07-1012	10.5 cm	Curved	Blunt



**FINE**



1/1

07-1301	9.0 cm	Straight	Sharp/Sharp
07-1302	10.0 cm	Straight	Sharp/Sharp
07-1303	11.5 cm	Straight	Sharp/Sharp



1/1

07-1311	9.0 cm	Curved	Sharp/Sharp
07-1312	10.0 cm	Curved	Sharp/Sharp
07-1313	11.5 cm	Curved	Sharp/Sharp



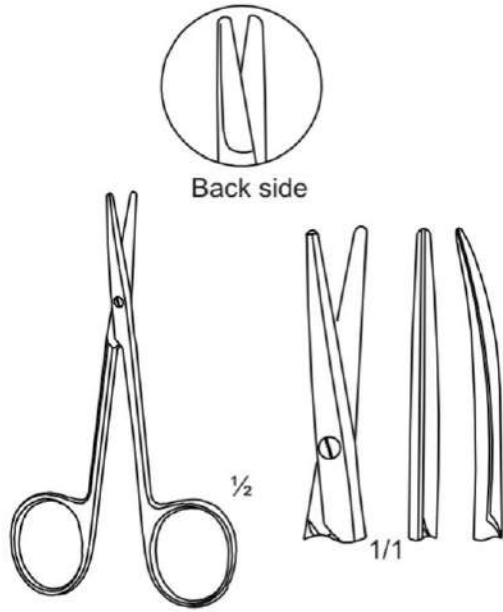

**STRABISMUS**

07-1401	11.0 cm	Straight
07-1411	11.0 cm	Curved

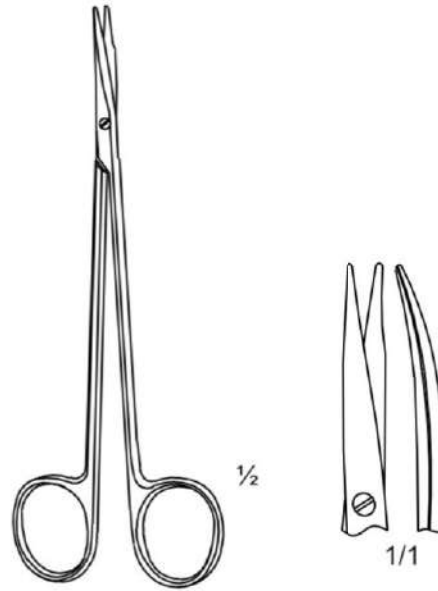

**JAMESON**

07-1501	14.5 cm	
07-1502	14.5 cm	Fine tips

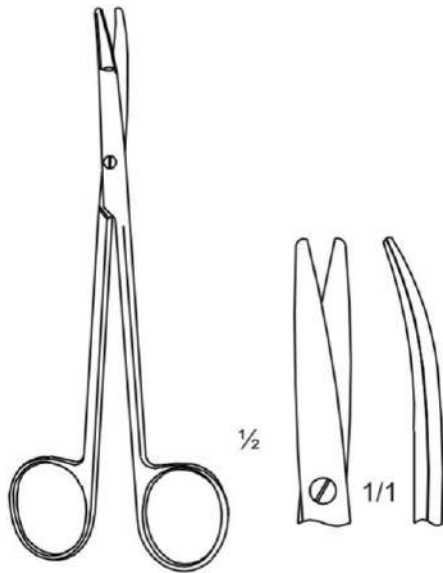

**KILNER**

Special flat points for dissecting and undermining skin

07-1601	12.0 cm	Curved
07-1602	13.0 cm	Curved
07-1603	15.0 cm	Curved

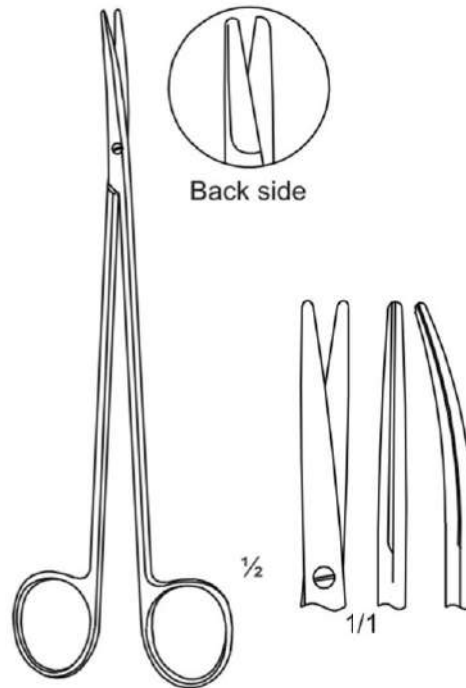

**TOENNIS-ADSON**

Very delicate pattern

07-1810	18.0 cm	Straight
07-1820	18.0 cm	Curved

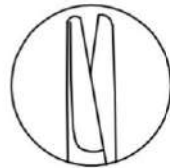
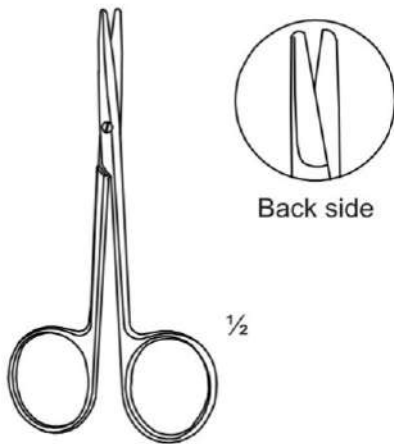

Back side

1/2



1/1

07-1901	11.0 cm	Straight
07-1911	11.0 cm	Curved

**METZEBNBAUM-BABY**

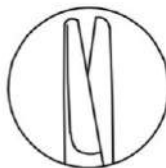
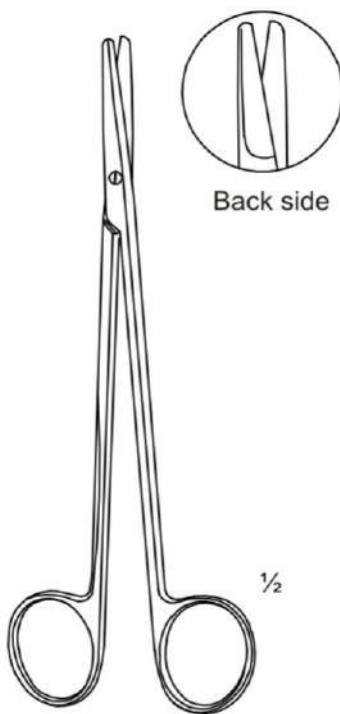

Back side

1/2

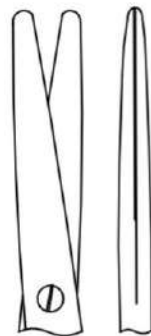

1/1

07-1902	14.0 cm	Straight	Blunt/Blunt
07-1903	18.0 cm	Straight	Blunt/Blunt
07-1904	20.0 cm	Straight	Blunt/Blunt
07-1905	23.0 cm	Straight	Blunt/Blunt
07-1906	25.0 cm	Straight	Blunt/Blunt
07-1907	28.0 cm	Straight	Blunt/Blunt
07-1908	30.5 cm	Straight	Blunt/Blunt

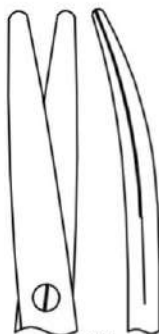

1/1

07-1912	14.0 cm	Curved	Blunt/Blunt
07-1913	18.0 cm	Curved	Blunt/Blunt
07-1914	20.0 cm	Curved	Blunt/Blunt
07-1915	23.0 cm	Curved	Blunt/Blunt
07-1916	25.0 cm	Curved	Blunt/Blunt
07-1917	28.0 cm	Curved	Blunt/Blunt
07-1918	30.5 cm	Curved	Blunt/Blunt

**METZENBAUM**  
Standard pattern



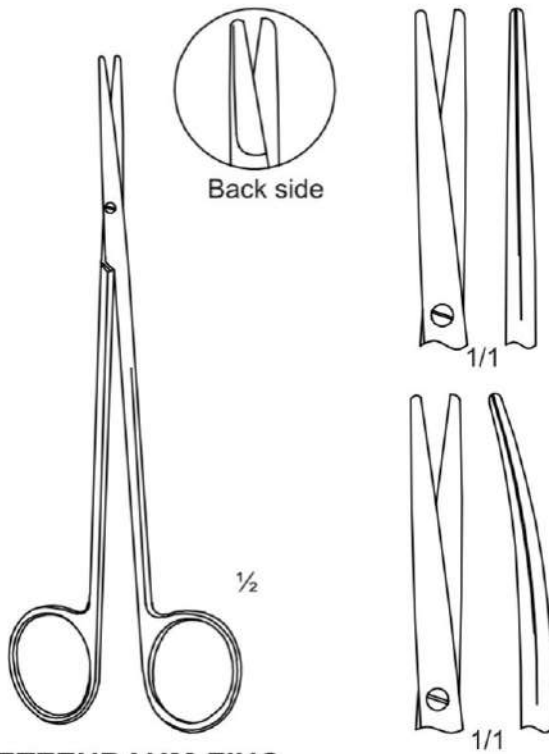

**METZENBAUM-FINO**  
Delicate pattern

07-2001	14.0 cm	Straight	Blunt/Blunt
07-2002	18.0 cm	Straight	Blunt/Blunt
07-2003	20.0 cm	Straight	Blunt/Blunt
07-2004	23.0 cm	Straight	Blunt/Blunt
07-2005	25.0 cm	Straight	Blunt/Blunt
07-2006	28.0 cm	Straight	Blunt/Blunt

07-2011	14.0 cm	Curved	Blunt/Blunt
07-2012	18.0 cm	Curved	Blunt/Blunt
07-2013	20.0 cm	Curved	Blunt/Blunt
07-2014	23.0 cm	Curved	Blunt/Blunt
07-2015	25.0 cm	Curved	Blunt/Blunt
07-2016	28.0 cm	Curved	Blunt/Blunt

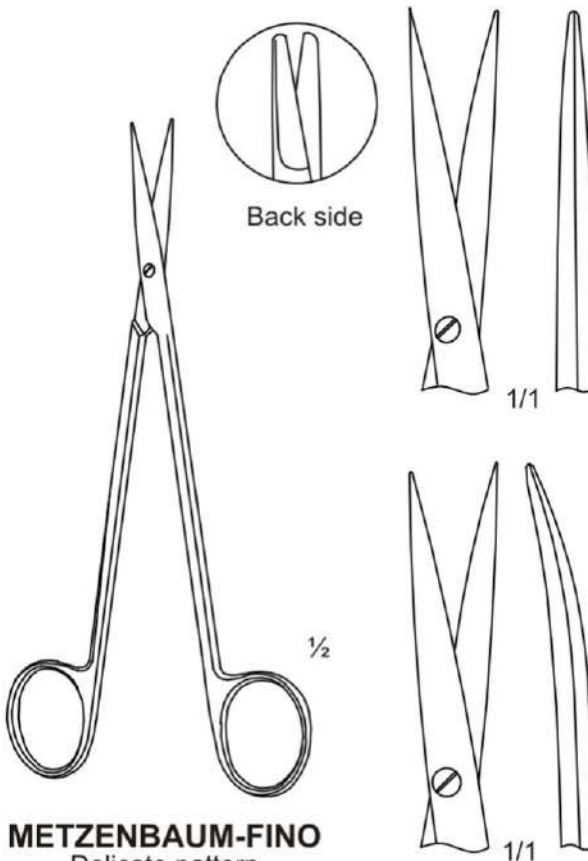

**METZENBAUM-FINO**  
Delicate pattern

07-2101	14.0 cm	Straight	Sharp/Sharp
07-2102	18.0 cm	Straight	Sharp/Sharp
07-2103	20.0 cm	Straight	Sharp/Sharp
07-2104	23.0 cm	Straight	Sharp/Sharp
07-2105	25.0 cm	Straight	Sharp/Sharp
07-2106	28.0 cm	Straight	Sharp/Sharp

07-2111	14.0 cm	Curved	Sharp/Sharp
07-2112	18.0 cm	Curved	Sharp/Sharp
07-2113	20.0 cm	Curved	Sharp/Sharp
07-2114	23.0 cm	Curved	Sharp/Sharp
07-2115	25.0 cm	Curved	Sharp/Sharp
07-2116	28.0 cm	Curved	Sharp/Sharp

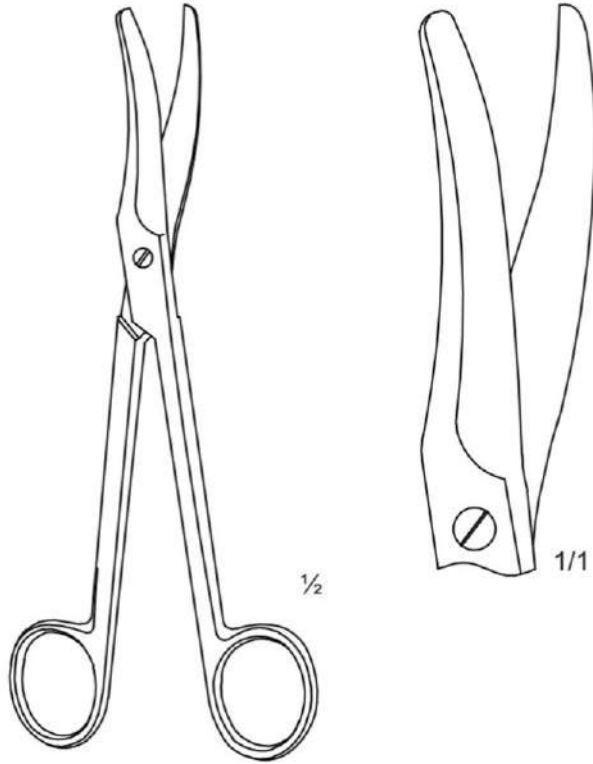

**EPISIOTOMY**

07-2300 | 19.0 cm

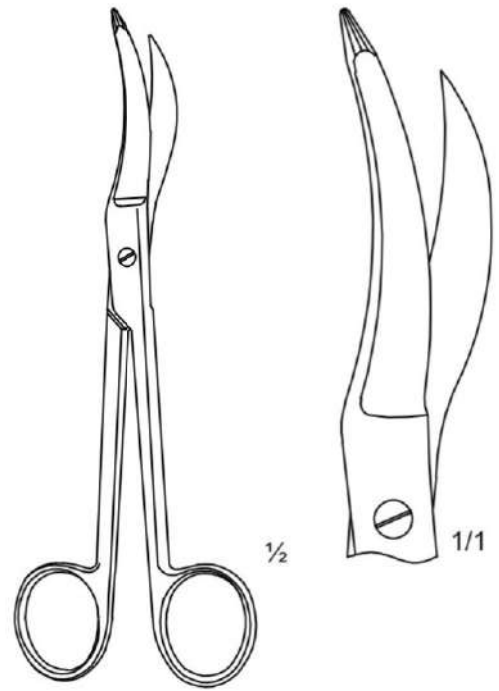

**WALDMANN**

07-2400 | 19.0 cm

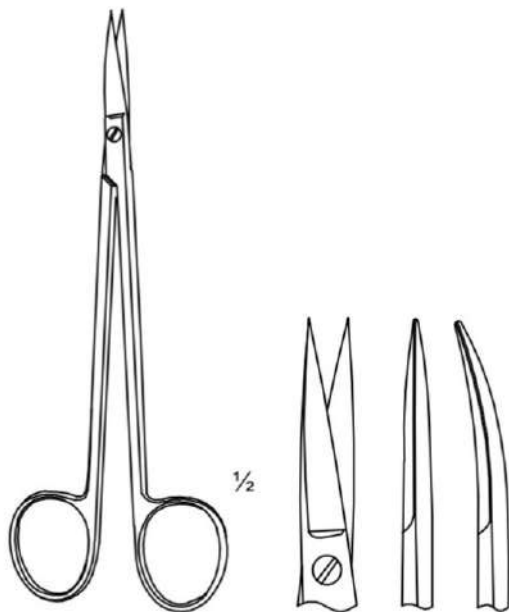

**KELLY**

07-2701 | 16.0 cm | Straight  
07-2711 | 16.0 cm | Curved

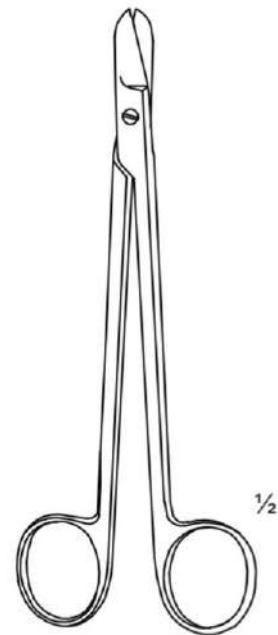

**SMITH**

Wire Cutting

07-3001 | 16.0 cm

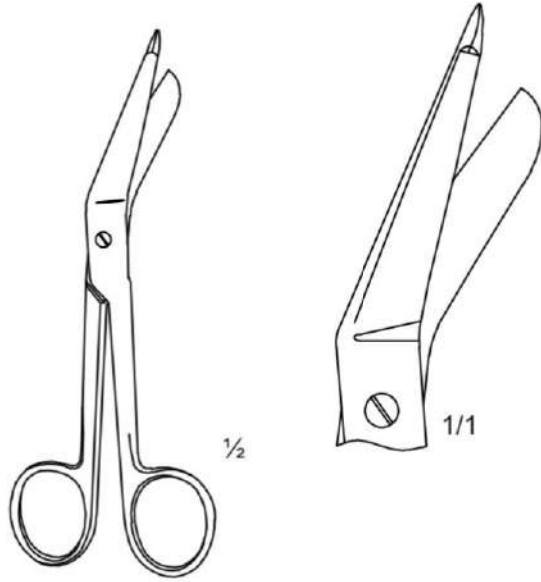

**LISTER**

07-3101	14.0 cm
07-3102	18.0 cm
07-3103	20.0 cm

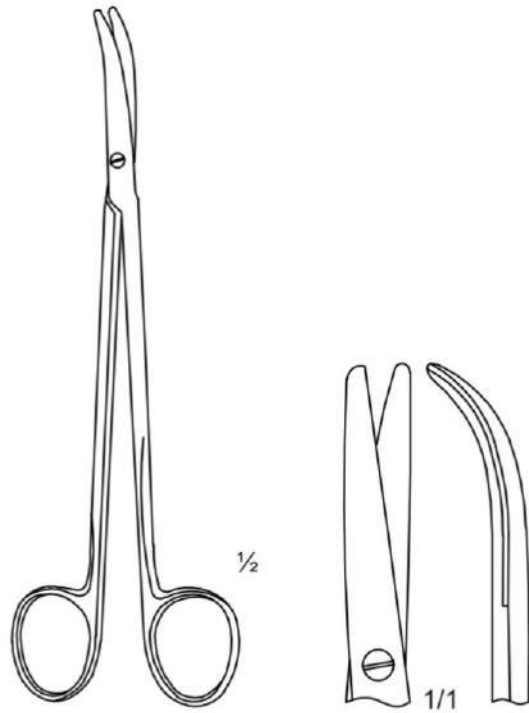

**HALLE**

Nasal Scissors

07-3200	19.0 cm
---------	---------

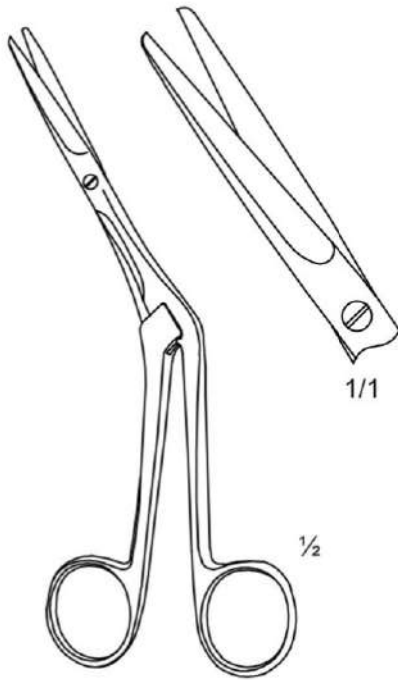

**HEYMANN-KNIGHT**  
Nasal Scissors

07-3201 | 18.0 cm | Blunt

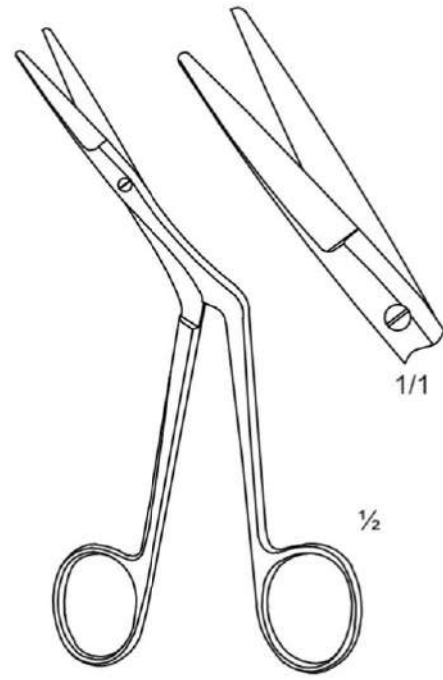

**HEYMANN**  
Nasal Scissors

07-3202 | 18.0 cm | Blunt

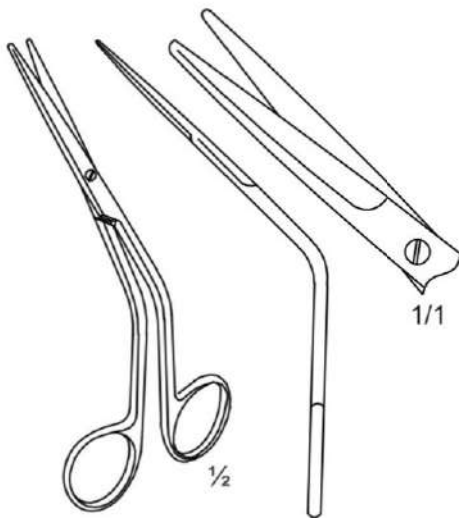

**FOMON**  
Nasal Scissors

07-3203 | 14.0 cm | Blunt

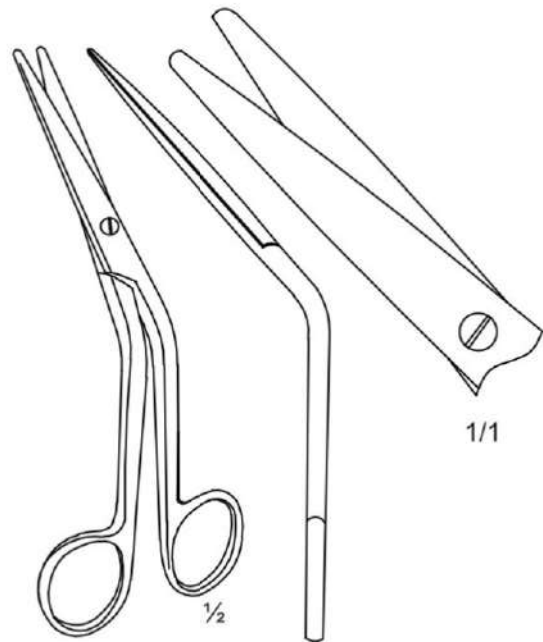

**COTTLE**  
Nasal Scissors

07-3204 | 16.0 cm | Blunt

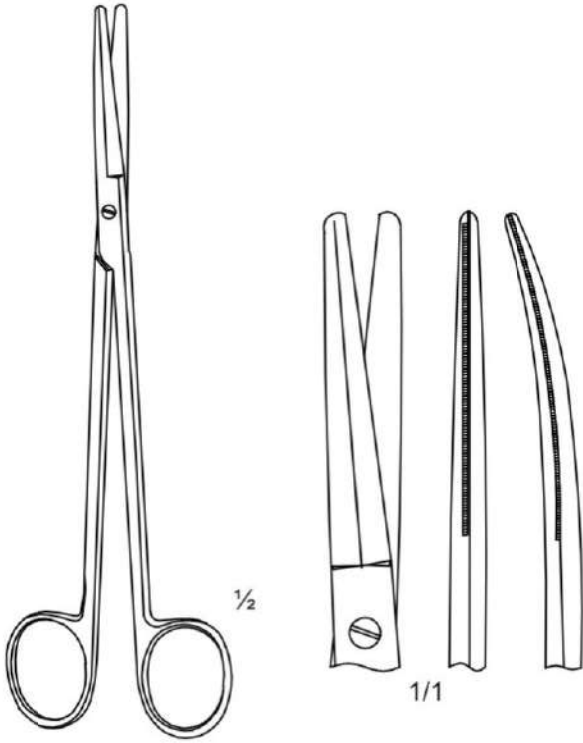

**GORNEY**  
Dissecting Scissors

07-3301	19.0 cm	Straight
07-3311	19.0 cm	Curved

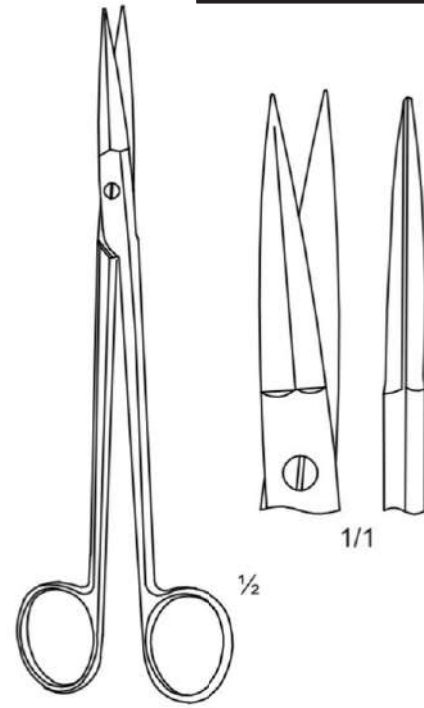

**MC INDOE**

07-3400	19.0 cm	Straight
---------	---------	----------

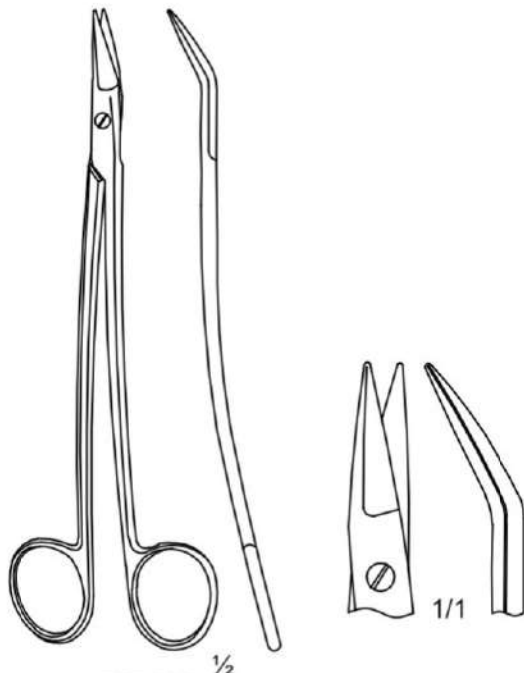

**DEAN**  
Curved on flat

07-3501	15.0 cm
07-3502	17.0 cm

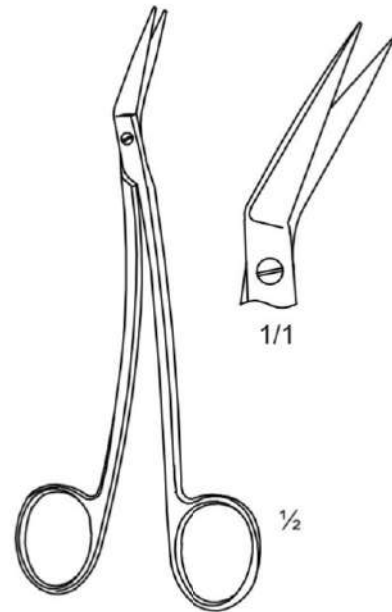

**LOCKLIN**  
Curved to side

07-3600	16.5 cm
---------	---------





25°

1/1

07-3701

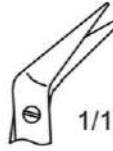

45°

1/1

07-3702



60°

1/1

07-3703



90°

1/1

07-3704



125°

1/1

07-3705

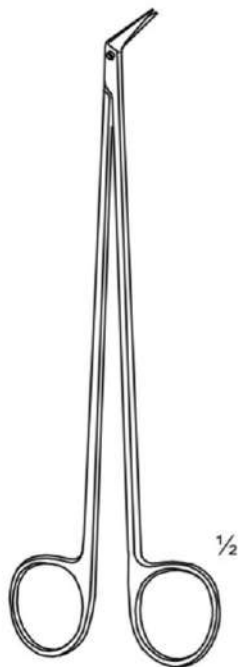

1/2

**HEGEMANN**  
Curved to side



25°

1/1

07-3801



45°

1/1

07-3802



60°

1/1

07-3803



125°

1/1

07-3804

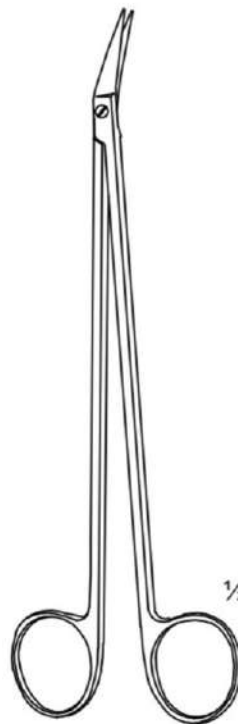

1/2

**POTTS-SMITH**  
Curved to side

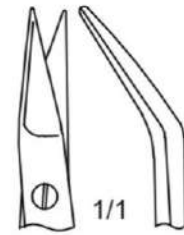

1/1

07-3901

17.0 cm

07-3902

19.5 cm

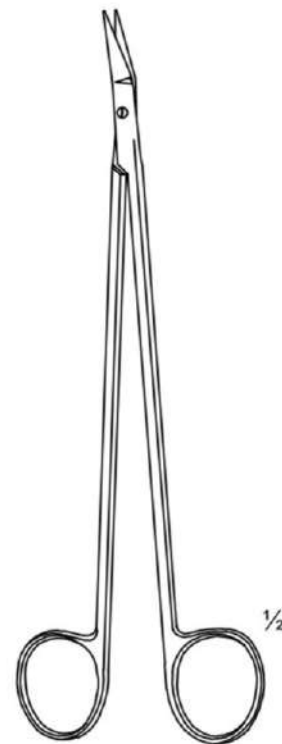

1/2

**POTTS-SMITH**  
Curved on flat



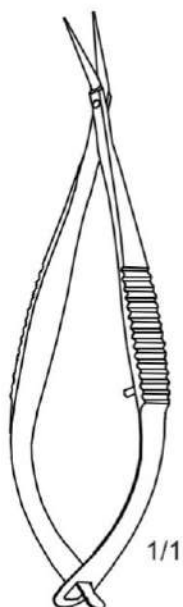

08-0101 8.0 cm

CAPSULOTOMY

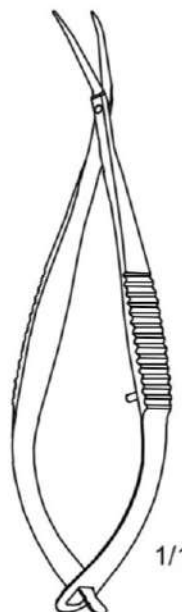

Angled blades with slightly curved point

08-0201 8.0 cm

ONG-TREUMER



slightly curved blades

08-0202 8.0 cm

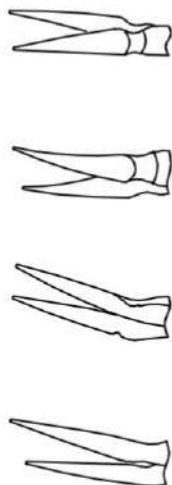
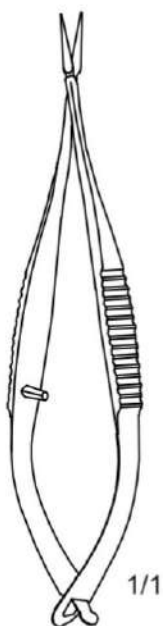

VANNAS



TRABECULAR

VANNAS-TUBINGEN  
After-Cataract Scissors

08-0301	Straight
08-0311	Curved

08-0401	Straight	Very delicate
08-0411	Curved	Very delicate
08-0402	Bent	Very delicate
08-0403	Angled on flat	Very delicate

08-0501	Straight
08-0511	Curved

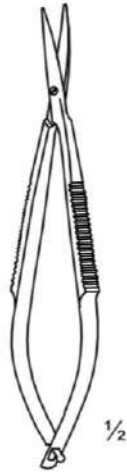

**WESTCOTT**  
Tenotomy Scissors

08-0601	Straight	Blunt
08-0602	Straight	Sharp
08-0611	Curved	Blunt
08-0612	Curved	Sharp



**WESTCOTT**  
Micro-Tenotomy Scissors

08-0701	Straight	Blunt
08-0702	Straight	Sharp
08-0711	Curved	Blunt
08-0712	Curved	Sharp



**WECKER**  
11 mm Blade

08-0801	Sharp - Sharp
08-0802	Sharp - Blunt, Left
08-0811	Sharp - Blunt, Right
08-0812	Blunt - Blunt

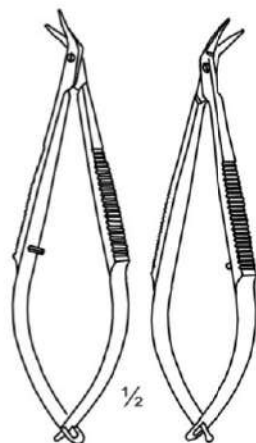

**CASTROVIEJO**  
Corneal Scissors

08-0901	Medium blades	Right
08-0902	Medium blades	Left
08-0903	Small blades	Right
08-0904	Small blades	Left

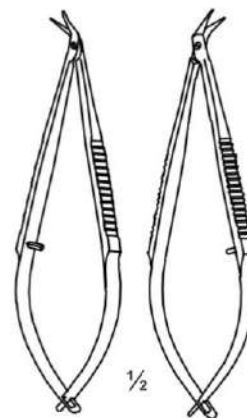

**TROUTMAN**  
Corneal Scissors

08-1001	Right
08-1002	Left

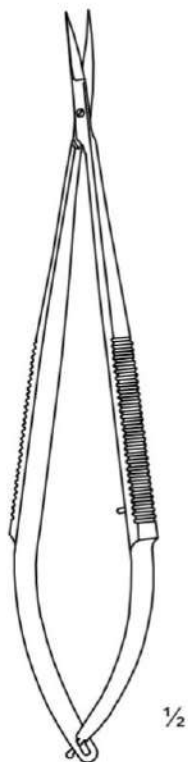

**MICRO SPRING**  
With flat handle



08-1101	15.0 cm	Straight	Blade 14mm
08-1102	18.0 cm	Straight	Blade 14mm
08-1103	15.0 cm	Straight	Blade 9mm
08-1104	18.0 cm	Straight	Blade 9mm



08-1111	15.0 cm	Curved	Blade 14mm
08-1112	18.0 cm	Curved	Blade 14mm
08-1113	15.0 cm	Curved	Blade 9mm
08-1114	18.0 cm	Curved	Blade 9mm



**MICRO SPRING**  
With round handle



08-1101R	15.0 cm	Straight	Blade 14mm
08-1102R	18.0 cm	Straight	Blade 14mm
08-1103R	15.0 cm	Straight	Blade 9mm
08-1104R	18.0 cm	Straight	Blade 9mm

**BLADES  
TOOTHED**

08-1201R	15.0 cm	Straight	Blade 14mm
08-1202R	18.0 cm	Straight	Blade 14mm
08-1203R	15.0 cm	Straight	Blade 9mm
08-1204R	18.0 cm	Straight	Blade 9mm



08-1111R	15.0 cm	Curved	Blade 14mm
08-1112R	18.0 cm	Curved	Blade 14mm
08-1113R	15.0 cm	Curved	Blade 9mm
08-1114R	18.0 cm	Curved	Blade 9mm

**BLADES  
TOOTHED**

08-1211R	15.0 cm	Curved	Blade 14mm
08-1212R	18.0 cm	Curved	Blade 14mm
08-1213R	15.0 cm	Curved	Blade 9mm
08-1214R	18.0 cm	Curved	Blade 9mm



08-1301 25° side way angled

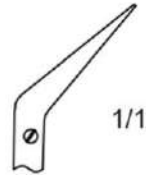

08-1302 45° side way angled

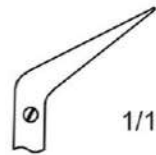

08-1303 60° side way angled



08-1304 90° side way angled

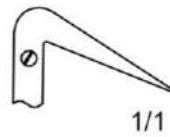

08-1305 125° side way angled



**MICRO SPRING**  
With flat handle

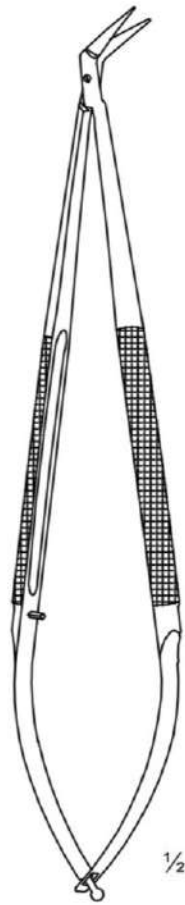

**MICRO SPRING**  
With round handle



08-1301R 25° side way angled

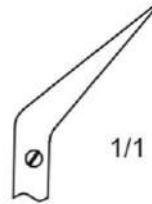

08-1302R 45° side way angled

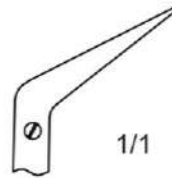

08-1303R 60° side way angled

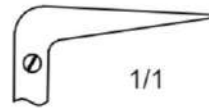

08-1304R 90° side way angled

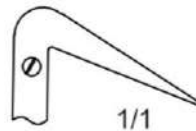

08-1305R 125° side way angled

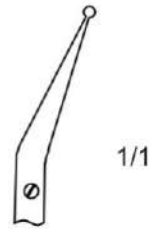

08-1401 25° side way angled

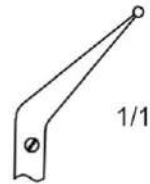

08-1402 45° side way angled

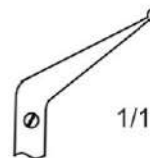

08-1403 60° side way angled

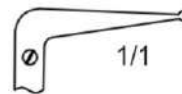

08-1404 90° side way angled

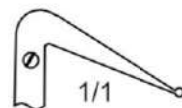

08-1405 125° side way angled

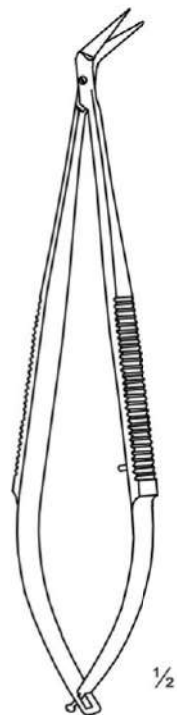

**MICRO SPRING**  
With flat handle / with ball point





08-1401R 25° side way angled

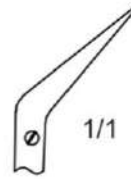

08-1402R 45° side way angled

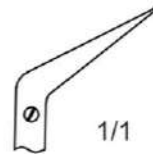

08-1403R 60° side way angled

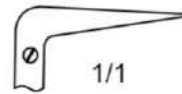

08-1404R 90° side way angled

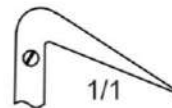

08-1405R 125° side way angled



**MICRO SPRING**

With round handle / with ball point



08-1501	12.0 cm	Straight
08-1502	16.0 cm	Straight

**VANNAS** 1/1



08-1511	12.0 cm	Curved
08-1512	16.0 cm	Curved

**VANNAS** 1/1



**BIEMER**  
Vein Scissors  
08-1601 13.0 cm



**VANNAS MICRO** 1/2



**VANNAS** 1/1  
08-1521 12.0 cm | angled on flat

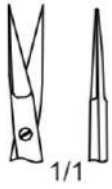

**YASARGIL**

08-1701 12.0 cm  
08-1702 16.0 cm  
08-1703 18.5 cm

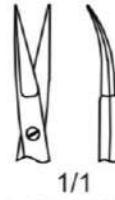

**YASARGIL**

08-1711 12.0 cm  
08-1712 16.0 cm  
08-1713 18.5 cm

**MILLESİ**  
Toothed blades

08-1801 16.0 cm

**MILLESİ**  
Toothed blades

08-1811 16.0 cm

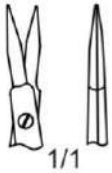

**VANNAS**

08-1503 12.0 cm  
08-1504 16.0 cm



**VANNAS**

08-1513 12.0 cm  
08-1514 16.0 cm



**BIEMER**  
Vein Scissors

08-1602 13.0 cm



**VANNAS**

08-1522 12.0 cm

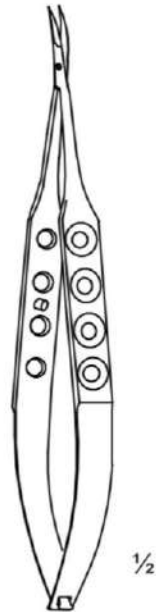

**YASARGIL**

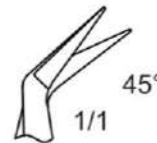

**POTTS-YASARGIL**

08-1901 18.5 cm



1/1

**YASARGIL**

08-1704	16.0 cm
08-1705	20.0 cm
08-1706	24.0 cm

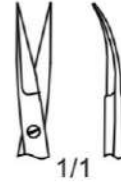

1/1

**YASARGIL**

08-1714	16.0 cm
08-1715	20.0 cm
08-1716	24.0 cm

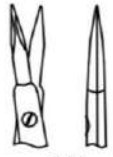

1/1

**VANNAS**

08-1505	16.0 cm
08-1506	20.0 cm
08-1507	24.0 cm

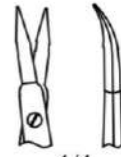

1/1

**VANNAS**

08-1515	16.0 cm
08-1516	20.0 cm
08-1517	24.0 cm

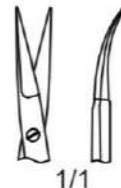

1/1

**YASARGIL**

08-1724	16.0 cm
08-1725	20.0 cm
08-1726	24.0 cm

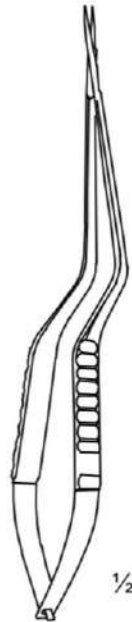

1/2

**VANNAS MICRO**



1/1

**YASARGIL**

08-2001	16.0 cm
08-2002	20.0 cm
08-2003	24.0 cm



1/1

**YASARGIL**

08-2011	16.0 cm
08-2012	20.0 cm
08-2013	24.0 cm



08-1707 22.5 cm  
08-2100 22.5 cm toothed blades



08-1717 22.5 cm

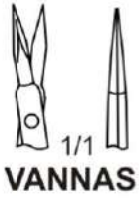

08-1508 22.5 cm



08-1518 22.5 cm

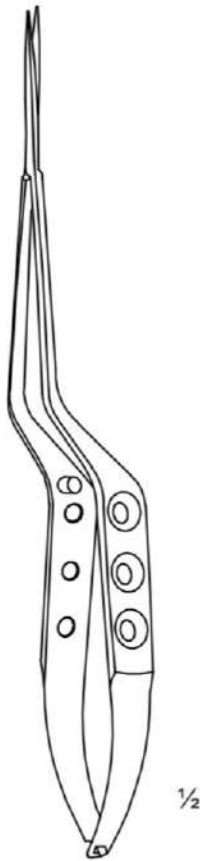

08-1727 22.5 cm



08-2004 22.5 cm



08-2014 22.5 cm

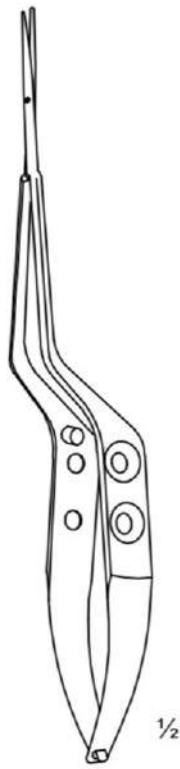

**YASARGIL**

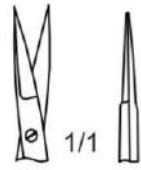

**YASARGIL**

08-1708 16.5 cm  
08-1709 20.0 cm



**YASARGIL**

08-1718 16.5 cm  
08-1719 20.0 cm

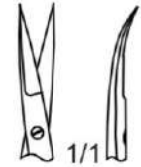

**YASARGIL**

08-1729 20.0 cm



**YASARGIL**

Dissecting Scissors

08-2005 20.0 cm



**YASARGIL**

Dissecting Scissors

08-2015 20.0 cm

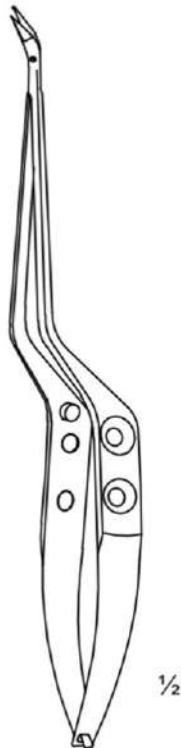

**NAGEL MICRO**



08-2201 20.0 cm



with probe-pointed blade

08-2202 20.0 cm



08-2203 20.0 cm





# Needle Holders

## Needle Holders

- *Needle Holders*
- *Needle Holders TC*
- *Micro Needle Holders*
- *Micro Needle Holders TC*

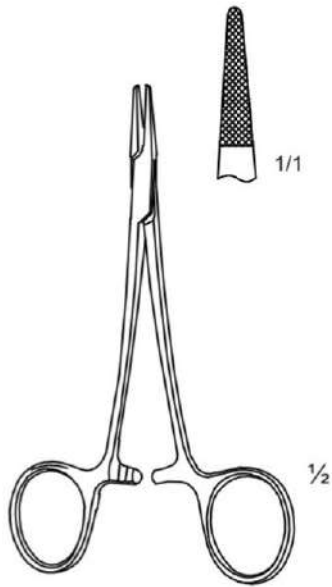

**HALSEY**

09-0100 | 13.0 cm | Serrated

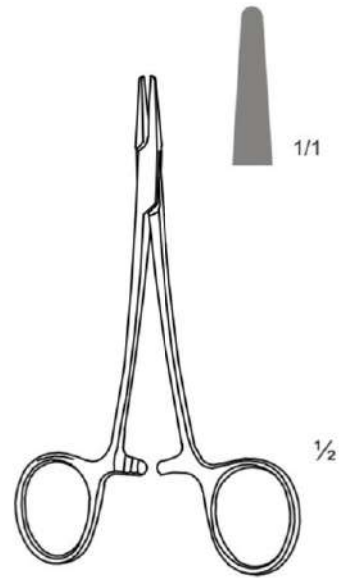

**WEBSTER**

09-0200 | 13.0 cm | Smooth

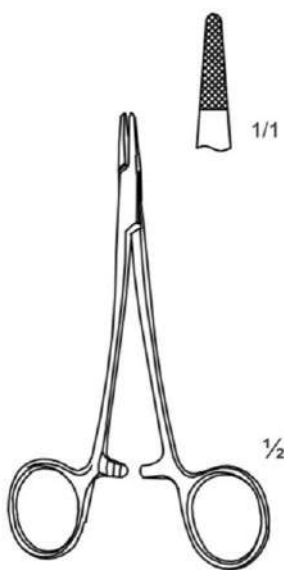

**DERF**

09-0300 | 12.0 cm

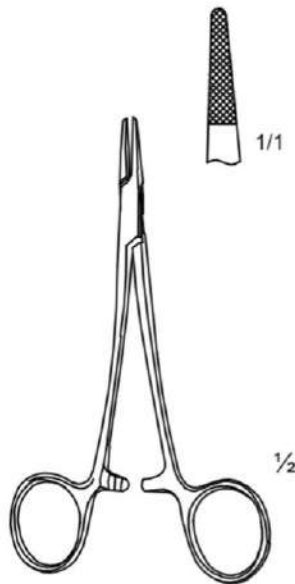

**CONVERSE**

09-0400 | 12.0 cm

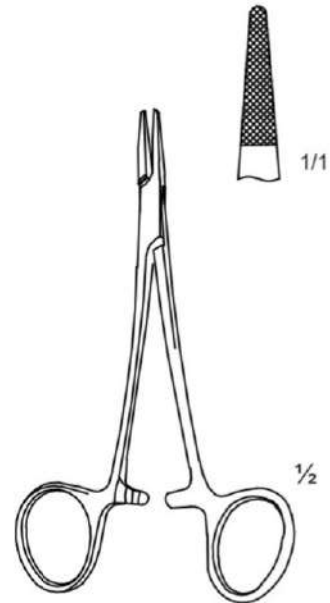

**NEIVERT**

09-0400 | 12.0 cm

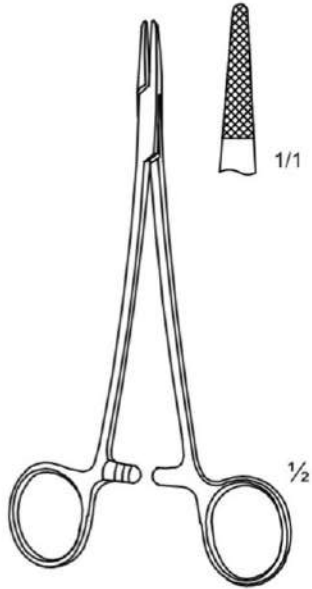

**BABY-CRILE-WOOD**  
Narrow Tips

09-0600 | 15.0 cm

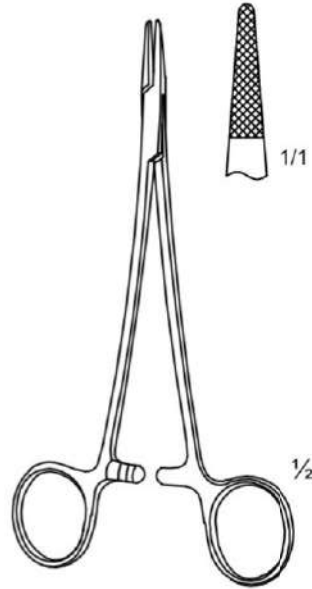

**CRILE-WOOD**

09-0700 | 15.0 cm

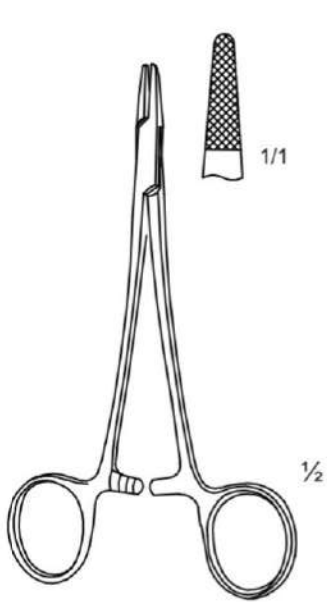

**BAUMGARTNER**

09-0800 | 14.0 cm

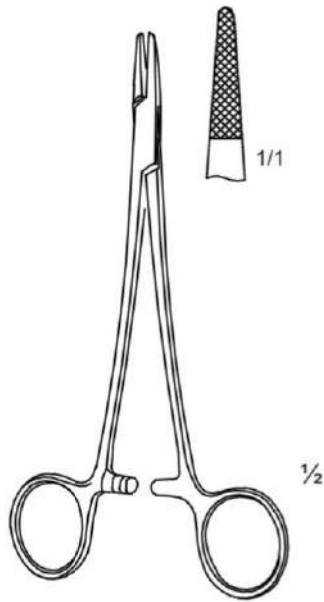

**CAROLL**

09-0900 | 15.0 cm

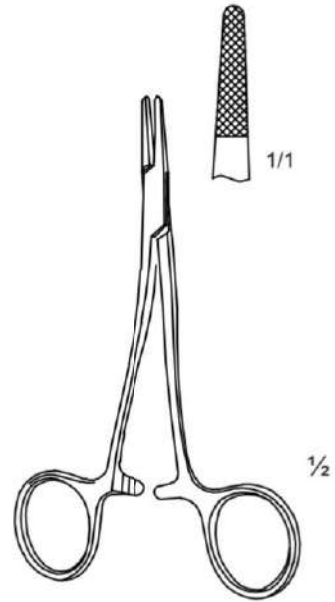

**KILNER**

09-1001 | 13.0 cm  
09-1002 | 15.0 cm

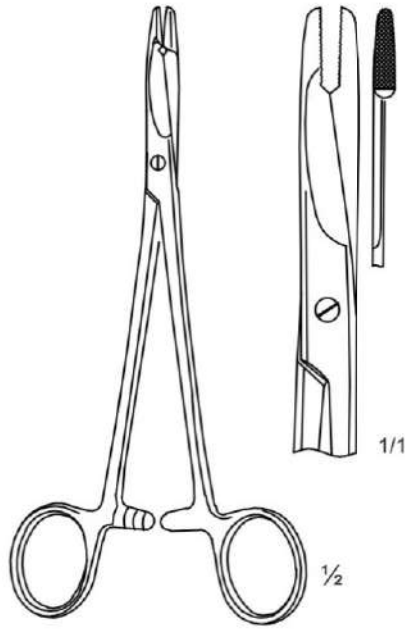

**OLSEN-HEGAR**

- ▶ 09-1101 14.5 cm
- ▶ 09-1102 16.5 cm
- ▶ 09-1103 18.5 cm

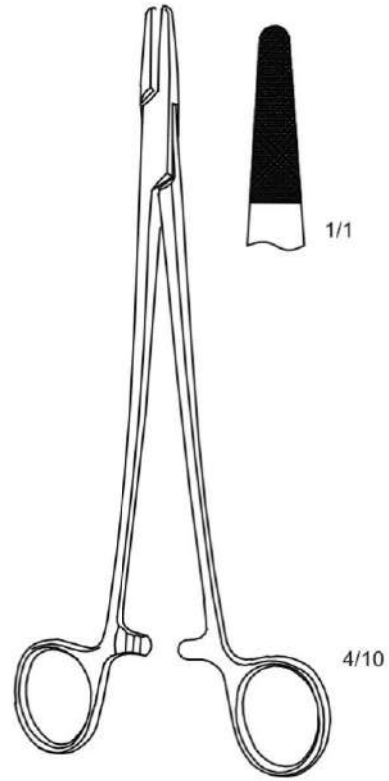

**HEGAR**

- 09-1201 20.0 cm
- 09-1202 24.0 cm

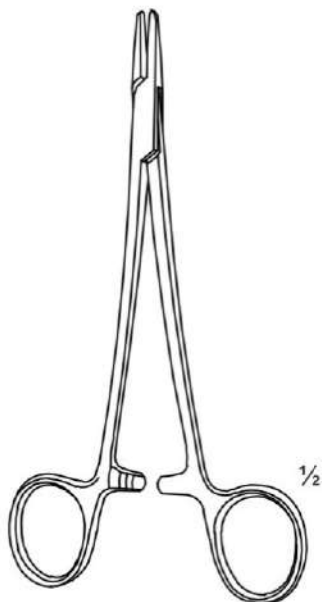

**MAYO-HEGAR**



1/1

- ▶ 09-1301 14.0 cm
- ▶ 09-1302 16.0 cm
- ▶ 09-1303 18.0 cm
- ▶ 09-1304 20.0 cm



1/1

- ▶ 09-1305 24.0 cm
- ▶ 09-1306 26.0 cm
- ▶ 09-1307 30.0 cm
- ▶ 09-1308 35.0 cm
- ▶ 09-1309 40.0 cm

**Needle Holders**

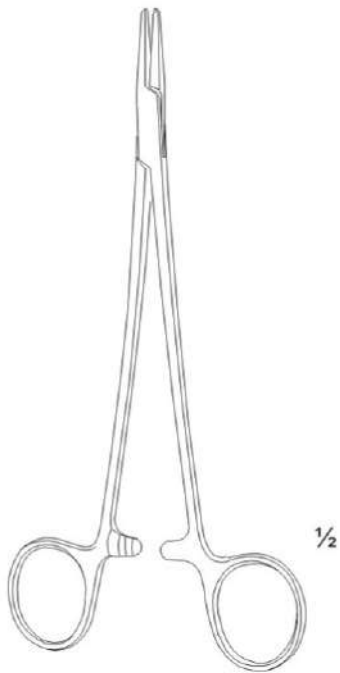

**DE BAKEY**



09-1401	18.0 cm
09-1402	20.0 cm
09-1403	23.0 cm



09-1404	26.0 cm
09-1405	30.0 cm
09-1406	37.0 cm

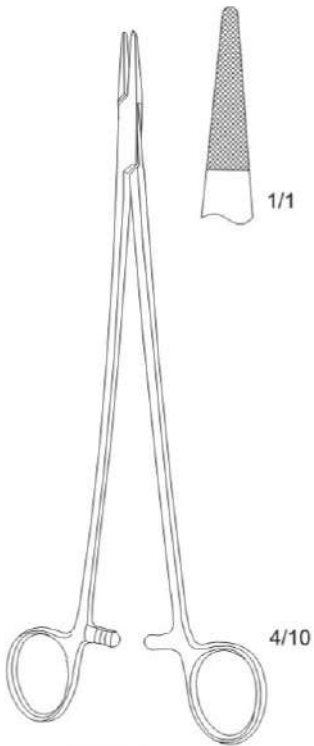

**JAMESON**

09-1500	23.5 cm
---------	---------

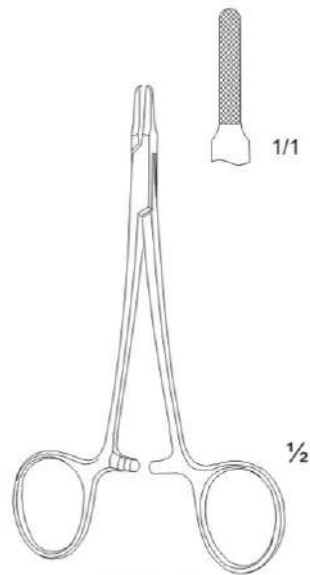

**RYDER**

09-1601	13.0 cm
09-1602	15.0 cm

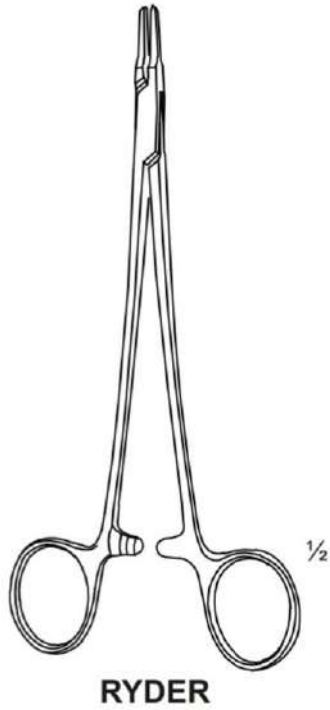

09-1603	18.0 cm
09-1604	20.0 cm
09-1605	23.0 cm
09-1606	26.0 cm

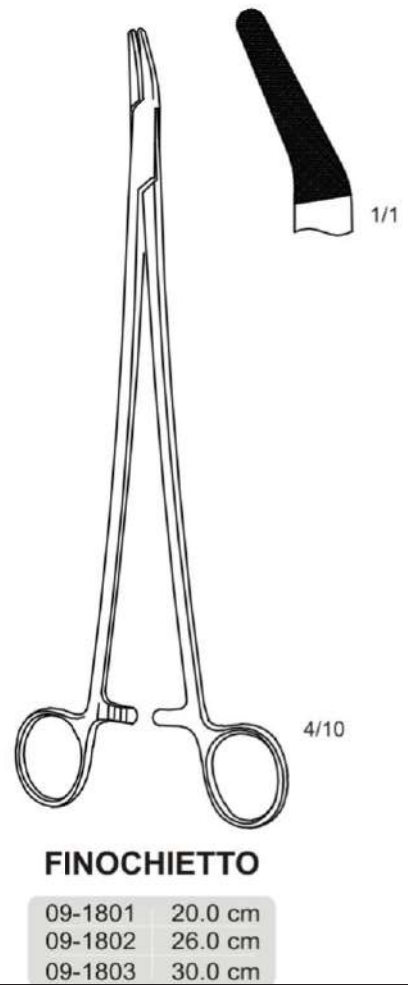
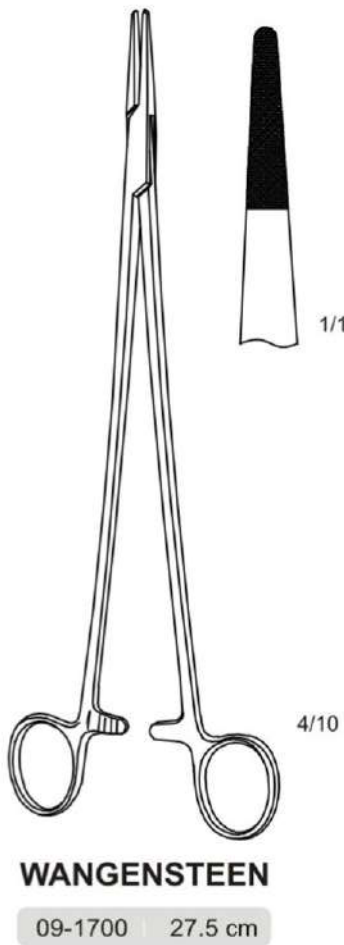



**Needle Holders**

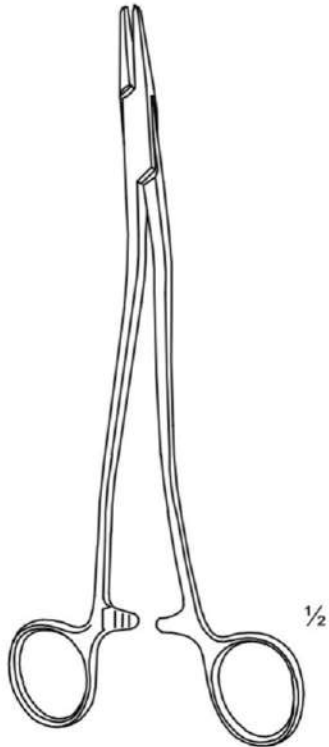

1/2

**BOZEMANN**



1/1

09-1901	20.0 cm
09-1902	24.0 cm
09-1903	26.0 cm

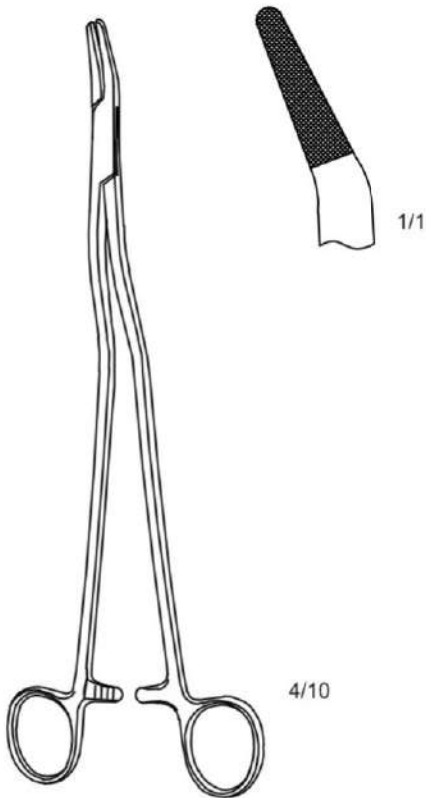

4/10

**FINOCHIETTO-BOZEMANN**

09-2001	20.0 cm
09-2002	26.0 cm

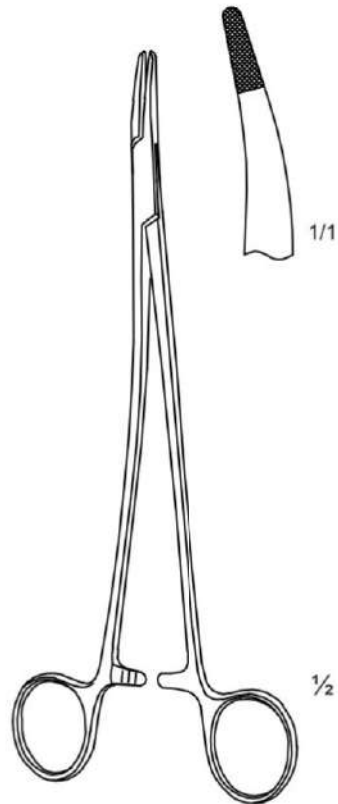

1/2

**STRATTE**

09-2101	20.0 cm
09-2102	23.0 cm

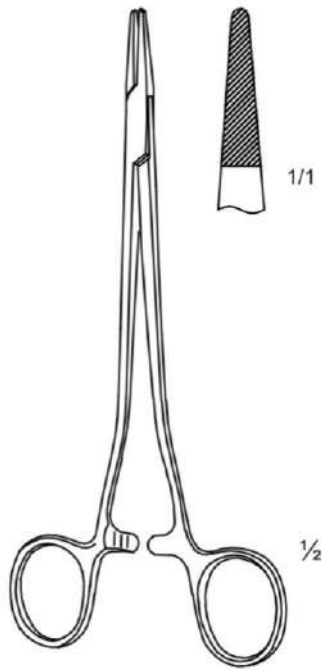

**SAROT**

09-2201	18.0 cm
09-2202	20.0 cm
09-2203	26.0 cm

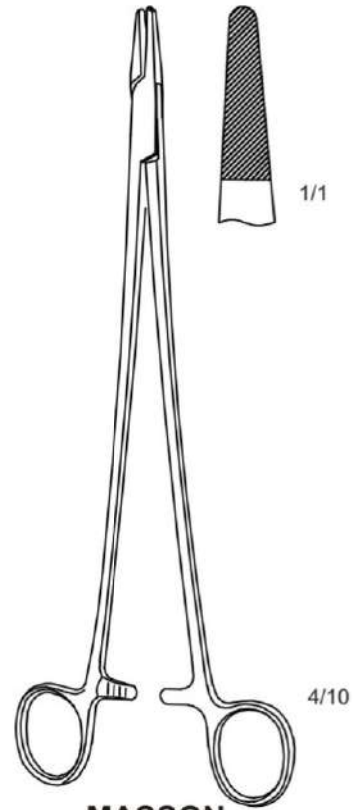

**MASSON**

09-2300	26.0 cm
---------	---------

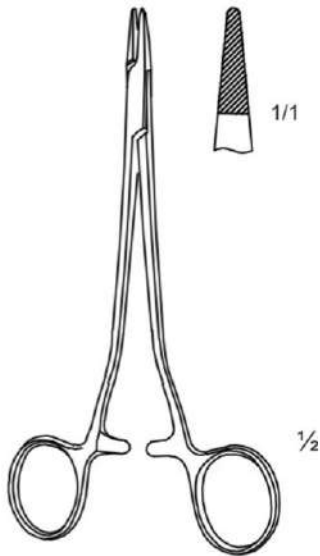

**SENNING**

09-2401	15.0 cm
09-2402	17.0 cm
09-2403	20.0 cm

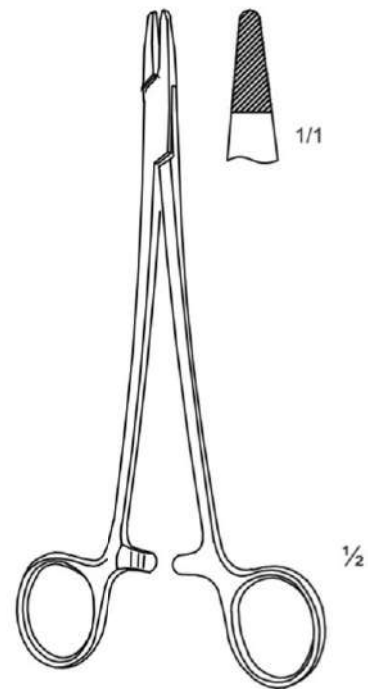

**NEW-ORLEANS**

09-2500	18.0 cm
---------	---------

## Micro Needle Holders

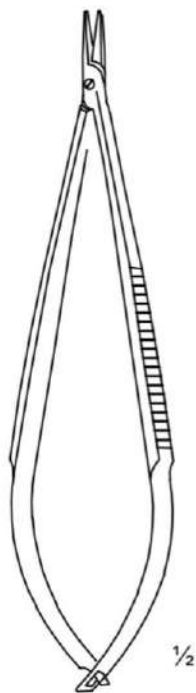

**CASTROVIEJO**  
Without lock



10-0101	14.0 cm	Straight/Smooth
10-0102	18.0 cm	Straight/Smooth
10-0103	21.0 cm	Straight/Smooth
10-0104	22.5 cm	Straight/Smooth
10-0201	14.0 cm	Straight/Serrated
10-0202	18.0 cm	Straight/Serrated
10-0203	21.0 cm	Straight/Serrated
10-0204	22.5 cm	Straight/Serrated

10-0111	14.0 cm	Curved/Smooth
10-0112	18.0 cm	Curved/Smooth
10-0113	21.0 cm	Curved/Smooth
10-0114	22.5 cm	Curved/Smooth
10-0211	14.0 cm	Curved/Serrated
10-0212	18.0 cm	Curved/Serrated
10-0213	21.0 cm	Curved/Serrated
10-0214	22.5 cm	Curved/Serrated

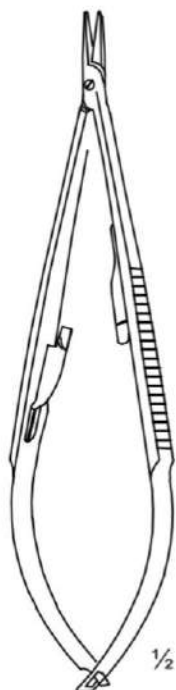

**CASTROVIEJO**  
With lock



10-0301	14.0 cm	Straight/Smooth
10-0302	18.0 cm	Straight/Smooth
10-0303	21.0 cm	Straight/Smooth
10-0304	22.5 cm	Straight/Smooth
10-0401	14.0 cm	Straight/Serrated
10-0402	18.0 cm	Straight/Serrated
10-0403	21.0 cm	Straight/Serrated
10-0404	22.5 cm	Straight/Serrated

10-0311	14.0 cm	Curved/Smooth
10-0312	18.0 cm	Curved/Smooth
10-0313	21.0 cm	Curved/Smooth
10-0314	22.5 cm	Curved/Smooth
10-0411	14.0 cm	Curved/Serrated
10-0412	18.0 cm	Curved/Serrated
10-0413	21.0 cm	Curved/Serrated
10-0414	22.5 cm	Curved/Serrated

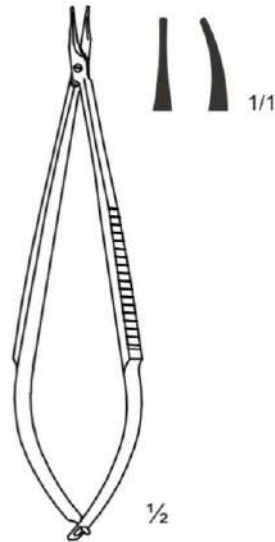

**MICRO-CASTROVIEJO**  
Without lock, with inserted jaws

10-0501	14.0 cm	Straight
10-0511	14.0 cm	Curved

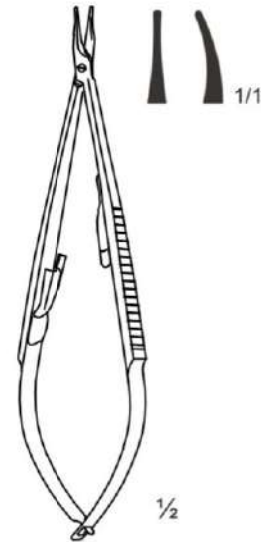

**MICRO-CASTROVIEJO**  
With lock, with inserted jaws

10-0502	14.0 cm	Straight
10-0512	14.0 cm	Curved

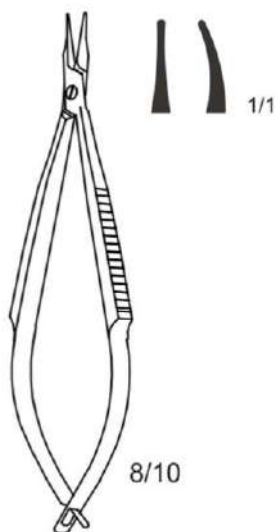

**MICRO-CASTROVIEJO**  
Without lock

10-0601	9.0 cm	Straight
10-0611	9.0 cm	Curved

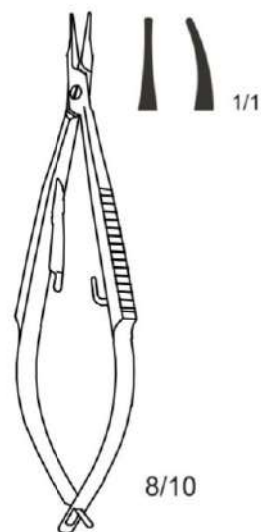

**MICRO-CASTROVIEJO**  
With lock

10-0602	9.0 cm	Straight
10-0612	9.0 cm	Curved

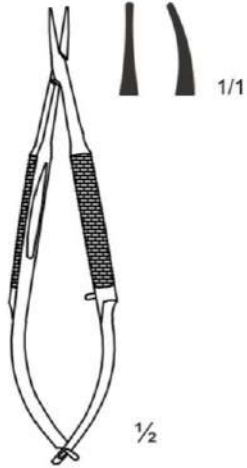

**BARRAQUER**  
Without lock

10-0701	12.0 cm	Straight
10-0711	12.0 cm	Curved

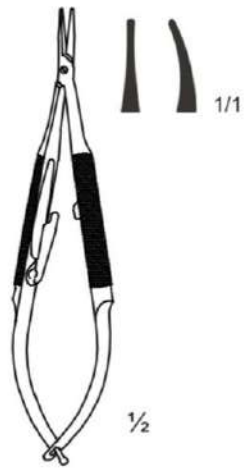

**BARRAQUER**  
With lock

10-0702	12.0 cm	Straight
10-0712	12.0 cm	Curved

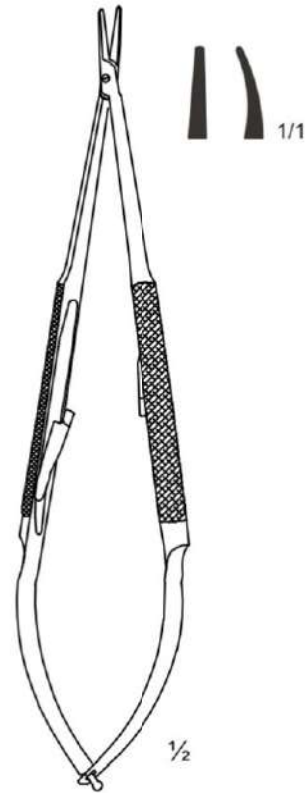

**BARRAQUER**  
With lock

10-0801	21.0 cm	Straight
10-0811	21.0 cm	Curved

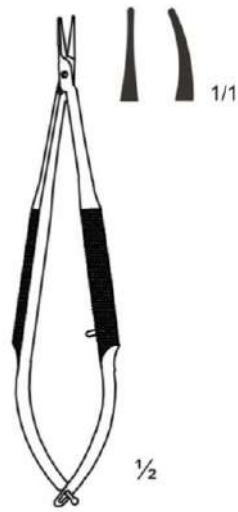

**BARRAQUER**  
Without lock

10-0901	13.0 cm	Straight
10-0911	13.0 cm	Curved

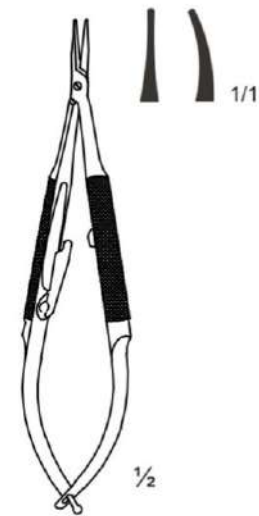

**BARRAQUER**  
With lock

10-0902	13.0 cm	Straight
10-0912	13.0 cm	Curved



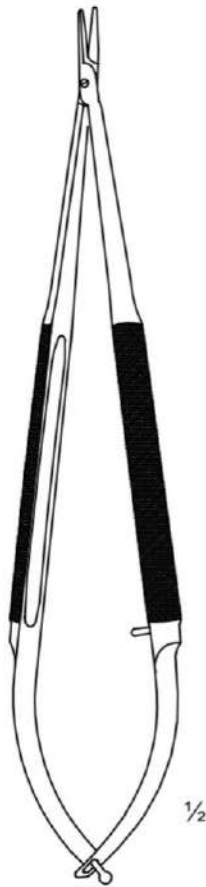

**BARRAQUER**  
Without lock



1001	14.0 cm	Straight
1002	15.0 cm	Straight
1003	18.0 cm	Straight
1004	21.0 cm	Straight
1005	23.0 cm	Straight
1011	14.5 cm	Curved
1012	15.0 cm	Curved
1013	18.0 cm	Curved
1014	21.0 cm	Curved
1015	23.5 cm	Curved



1101	14.0 cm	Straight
1102	15.0 cm	Straight
1103	18.0 cm	Straight
1104	21.0 cm	Straight
1105	23.0 cm	Straight
1111	14.5 cm	Curved
1112	15.0 cm	Curved
1113	18.0 cm	Curved
1114	21.0 cm	Curved
1115	23.5 cm	Curved



**BARRAQUER**  
With lock



Delicate

10-1201	14.0 cm	Straight
10-1202	15.0 cm	Straight
10-1203	18.0 cm	Straight
10-1204	21.0 cm	Straight
10-1205	23.0 cm	Straight
10-1211	14.5 cm	Curved
10-1212	15.0 cm	Curved
10-1213	18.0 cm	Curved
10-1214	21.0 cm	Curved
10-1215	23.5 cm	Curved



Micro

10-1301	14.0 cm	Straight
10-1302	15.0 cm	Straight
10-1303	18.0 cm	Straight
10-1304	21.0 cm	Straight
10-1305	23.0 cm	Straight
10-1311	14.5 cm	Curved
10-1312	15.0 cm	Curved
10-1313	18.0 cm	Curved
10-1314	21.0 cm	Curved
10-1315	23.5 cm	Curved



1/1

10-1401	14.0 cm	Straight/with big lock
10-1402	14.0 cm	Straight/with small lock
10-1411	14.0 cm	Curved/with big lock
10-1412	14.0 cm	Curved/with small lock

1/2

**ARRUGA**

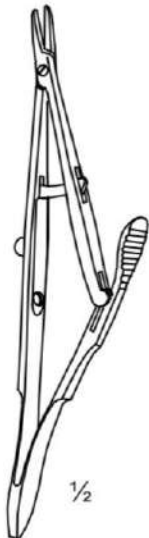

1/1

1/2

**KALT**

10-1601	14.0 cm	Straight
10-1611	14.0 cm	Curved



1/2

**CASTROVIEJO**  
Razor Blade Holder

10-1700	13.0 cm
---------	---------

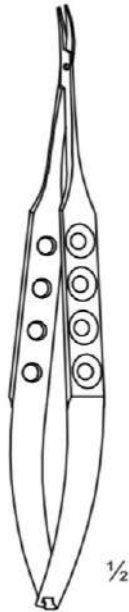

Without lock



10-1801	16.0 cm	Straight
10-1802	18.5 cm	Straight



10-1811	16.0 cm	Curved
10-1812	18.5 cm	Curved



**YASARGIL**  
Without lock



10-1902	20.0 cm	Straight
10-1903	22.5 cm	Straight



10-1911	16.5 cm	Curved
10-1912	20.0 cm	Curved
10-1913	22.5 cm	Curved
10-1914	24.5 cm	Curved

# Micro Needle Holders



Without lock



1/1

10-2001	16.0 cm	Straight
10-2002	20.0 cm	Straight
10-2003	24.0 cm	Straight



1/1

10-2011	16.0 cm	Straight
10-2012	20.0 cm	Straight
10-2013	24.0 cm	Straight

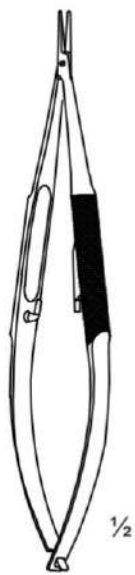

TITANIUM



1/1

10-2101	15.0 cm	with lock
10-2102	18.0 cm	with lock
10-2103	21.0 cm	with lock

10-2201	15.0 cm	without lock
10-2202	18.0 cm	without lock
10-2203	21.0 cm	without lock



1/1

10-2111	15.0 cm	with lock
10-2112	18.0 cm	with lock
10-2113	21.0 cm	with lock

10-2211	15.0 cm	without lock
10-2212	18.0 cm	without lock
10-2213	21.0 cm	without lock

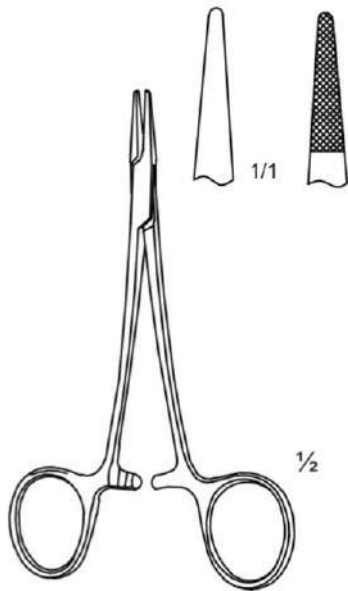

**HALSEY**

11-0100	13.0 cm	Smooth
11-0101	13.0 cm	Serrated

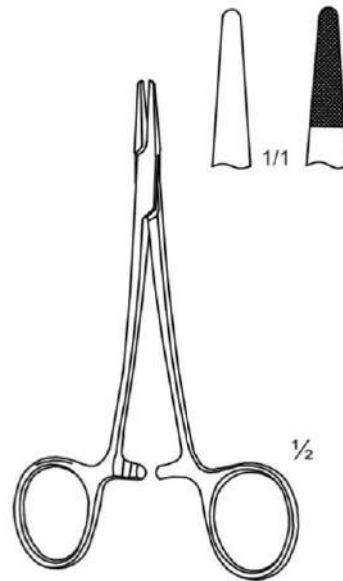

**WEBSTER**

11-0200	13.0 cm	Smooth
11-0201	13.0cm	Serrated

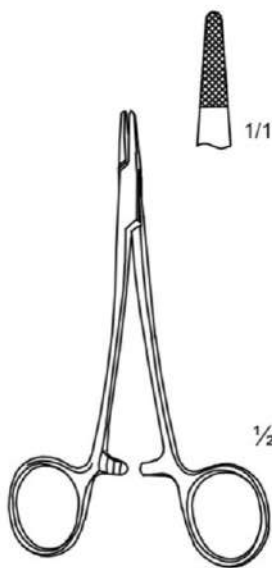

**DERF**

11-0300	12.0 cm
---------	---------

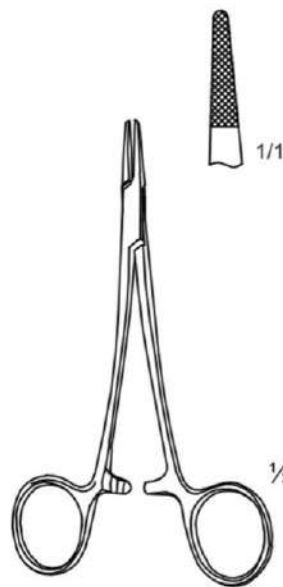

**CONVERSE**

11-0400	12.0 cm
---------	---------

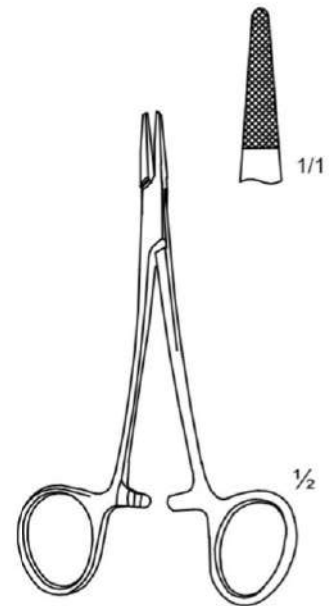

**NEIVERT**

11-0500	13.0 cm
---------	---------



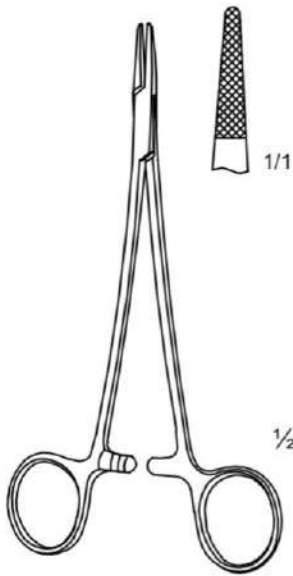

**BABY-CRILEWOOD**

11-0600 15.0 cm

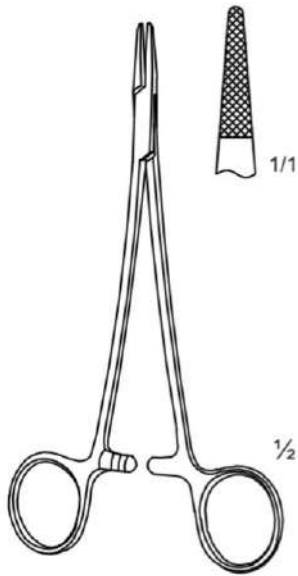

**CRILEWOOD**

11-0700 15.0 cm

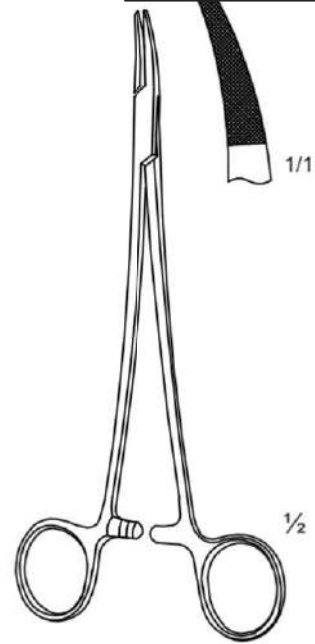

**CRILEWOOD**  
Curved jaw

- ▶ 11-0710 18.0 cm Curved
- ▶ 11-0711 23.0 cm Curved

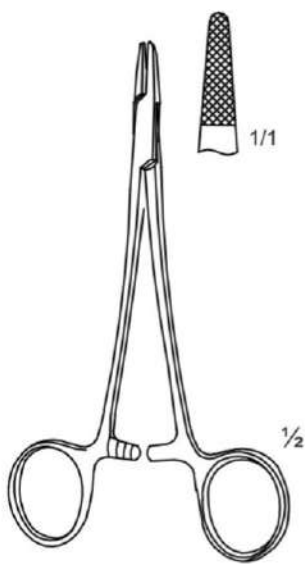

**BAUMGARTNER**

11-0800 14.0 cm

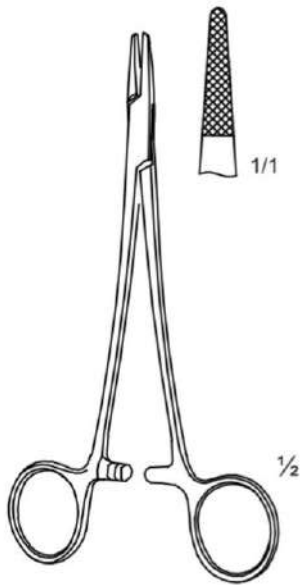

**CAROLL**

11-0900 15.0 cm

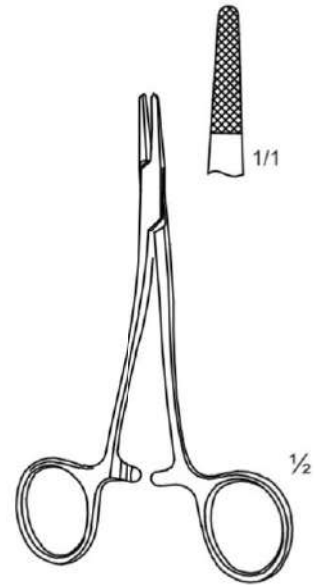

**KILNER**

- 11-1001 13.0 cm
- 11-1002 15.0 cm

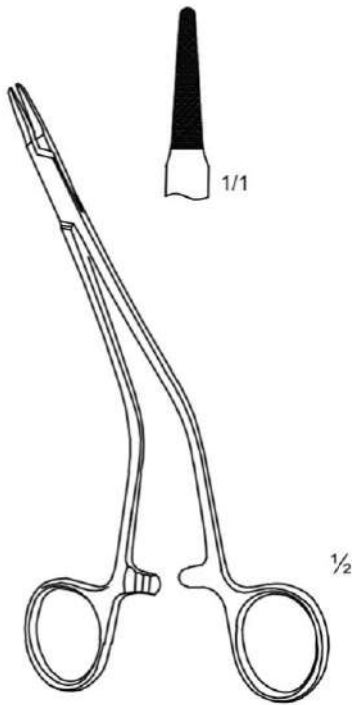

**PAREL**

11-1101	15.0 cm
11-1102	18.0 cm

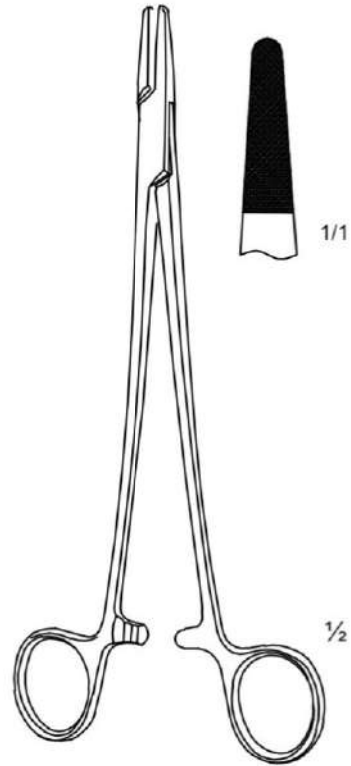

**HEGAR**

11-1201	20.0 cm
11-1202	24.0 cm

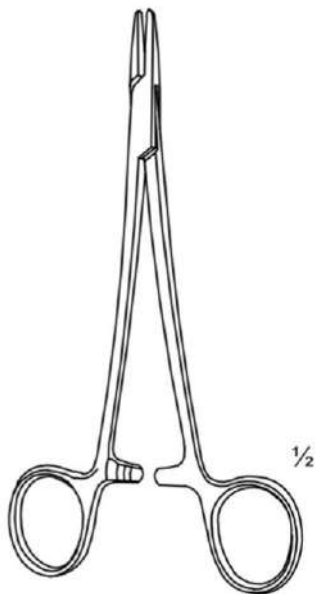

**MAYO-HEGAR**

▶ 11-1301	14.0 cm
▶ 11-1302	16.0 cm
▶ 11-1303	18.0 cm
▶ 11-1304	20.0 cm

▶ 11-1305	24.0 cm
▶ 11-1306	26.0 cm
▶ 11-1307	30.0 cm
▶ 11-1308	35.0 cm
▶ 11-1309	40.0 cm

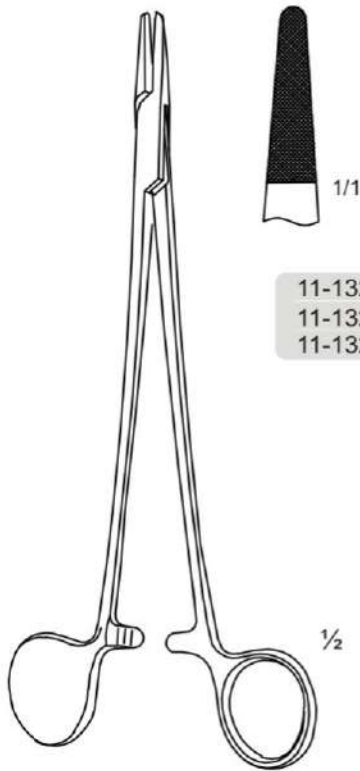

11-1321	14.0 cm
11-1322	16.0 cm
11-1323	20.0 cm

**MAYO-HEGAR**  
Very delicate

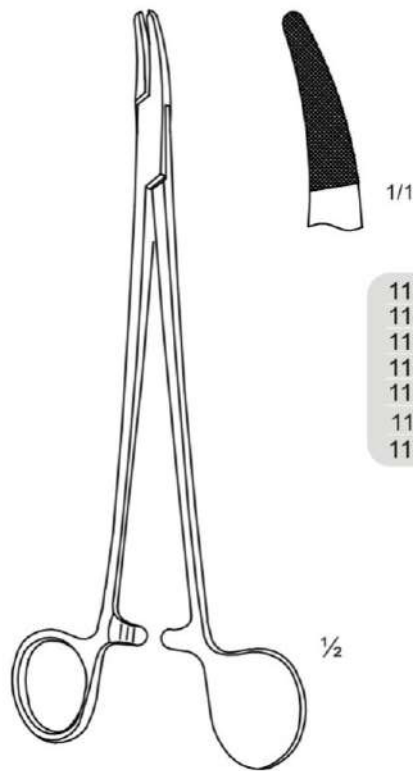

11-1311	14.0 cm
11-1312	16.0 cm
11-1313	18.0 cm
11-1314	20.0 cm
11-1315	24.0 cm
11-1316	26.0 cm
11-1317	30.0 cm

**HEANEY**  
Curved jaw

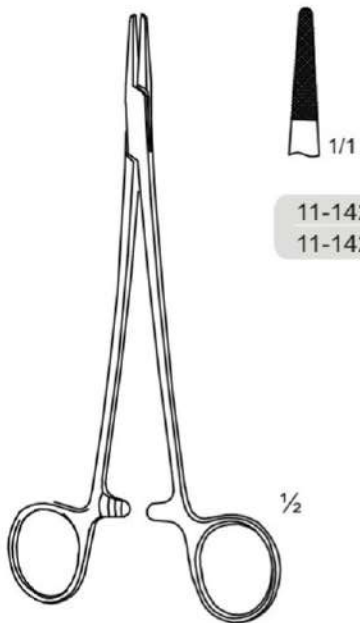

11-1421	16.5 cm
11-1422	21.0 cm

**DE BAKEY**  
Very delicate

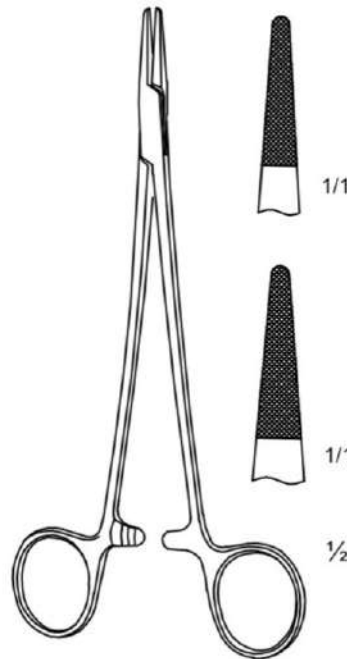

11-1401	18.0 cm
11-1402	20.0 cm
11-1403	23.0 cm

11-1404	26.0 cm
11-1405	30.0 cm
11-1406	37.0 cm

**DE BAKEY**

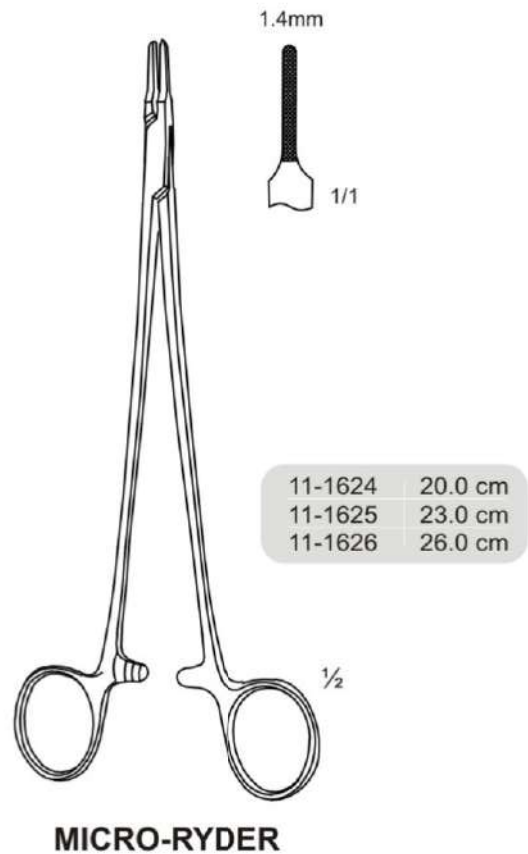
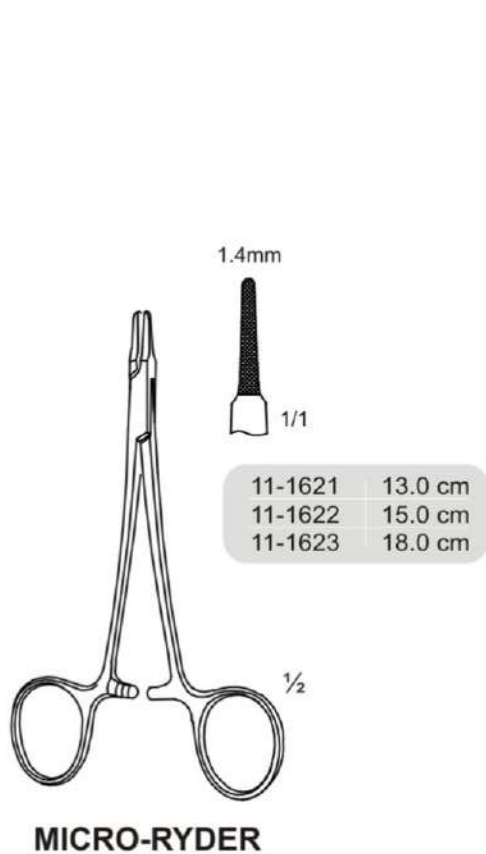
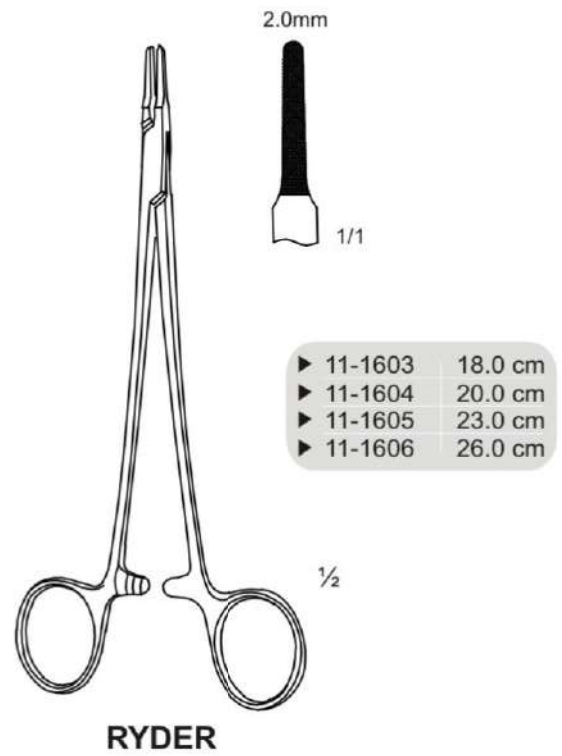
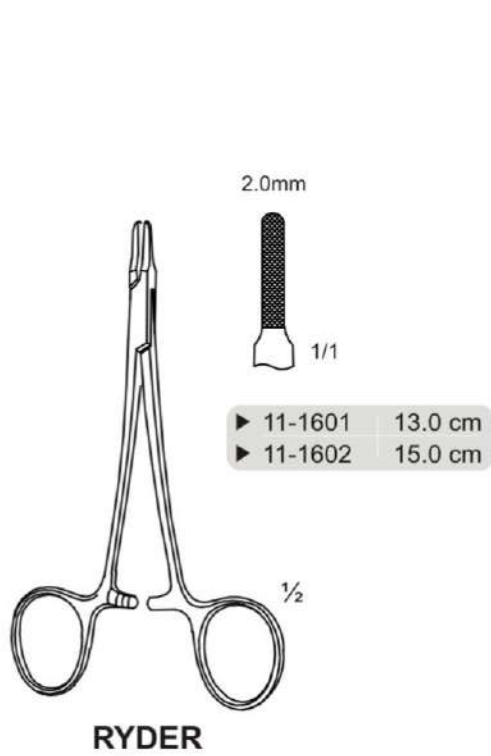

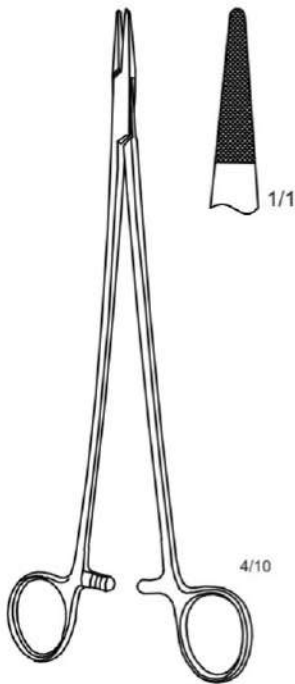

**JAMESON**

11-1500 23.5 cm

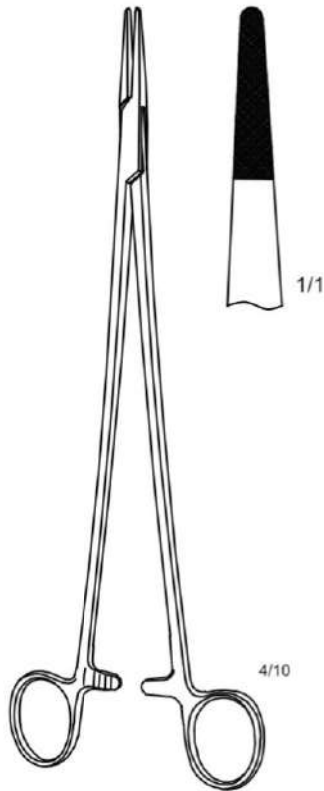

**WANGENSTEEN**

11-1700 27.5 cm

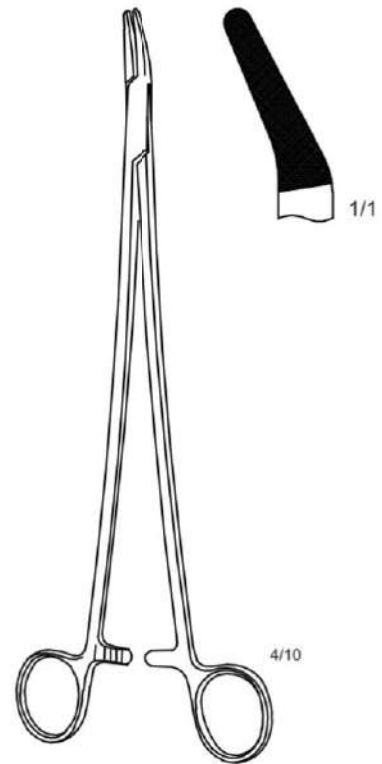

**FINOCHIETTO**  
angled jaw

11-1801	20.0 cm
11-1802	26.0 cm
11-1803	30.0 cm

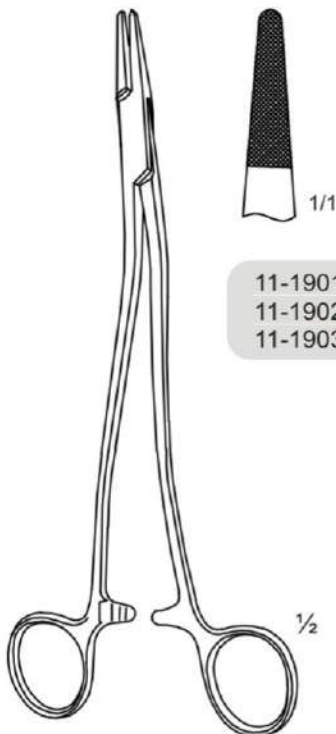

**BOZEMANN**

11-1901	20.0 cm
11-1902	24.0 cm
11-1903	26.0 cm

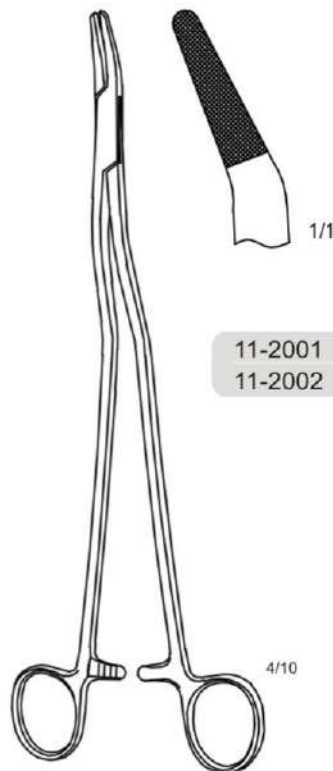

**FINOCHIETTO-BOZEMANN**  
angled jaw

11-2001	20.0 cm
11-2002	26.0 cm



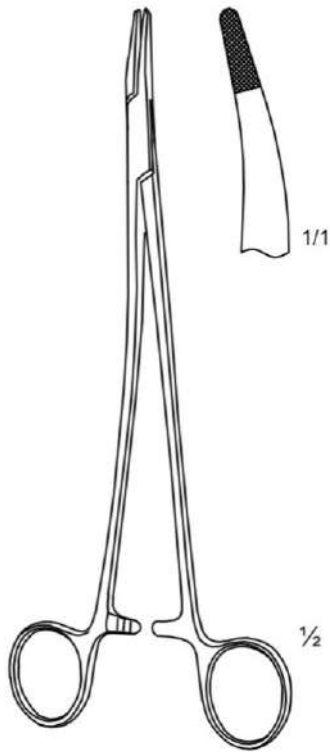

**STRATTE**

11-2101	20.0 cm
11-2102	23.0 cm

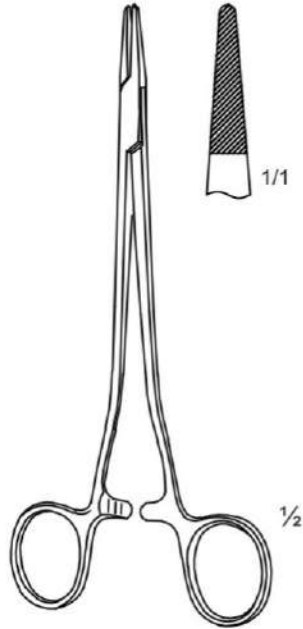

**SAROT**

11-2201	18.0 cm
11-2202	20.0 cm
11-2203	26.0 cm

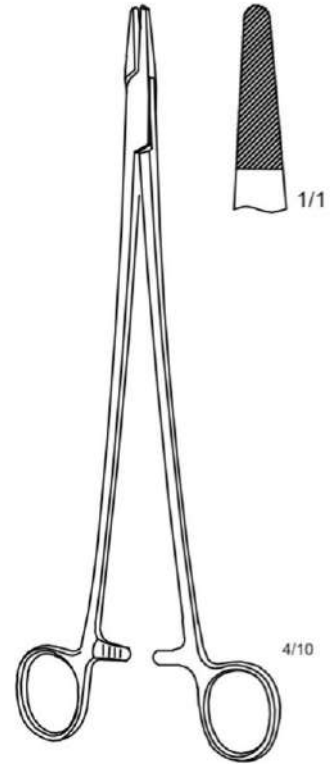

**MASSON**

11-2300	26.0 cm
---------	---------

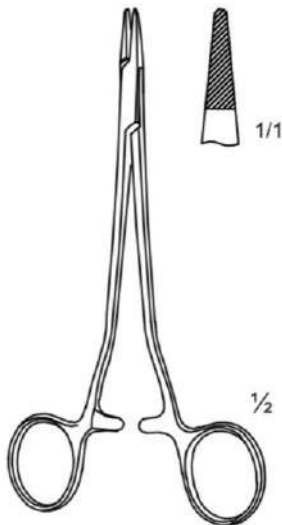

**SENNING**

11-2401	15.0 cm
11-2402	17.0 cm
11-2403	20.0 cm

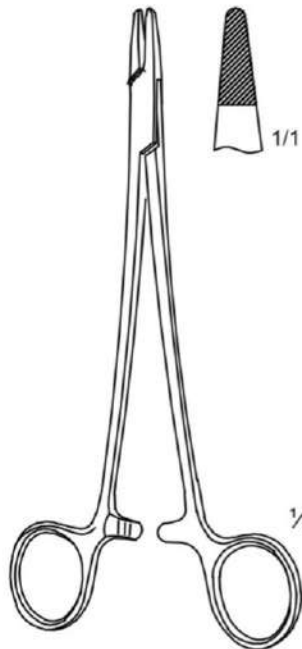

**NEW-ORLEANS**

11-2500	18.0 cm
---------	---------

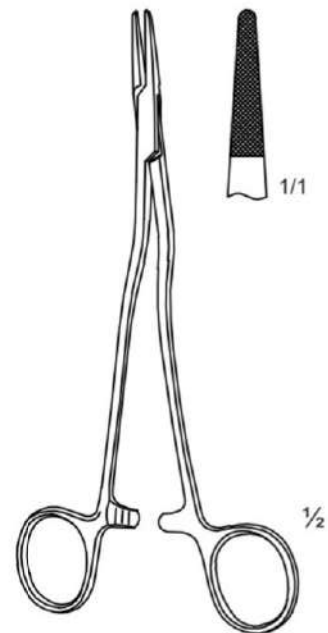

**JACOBSON**

11-2600	18.0 cm
---------	---------



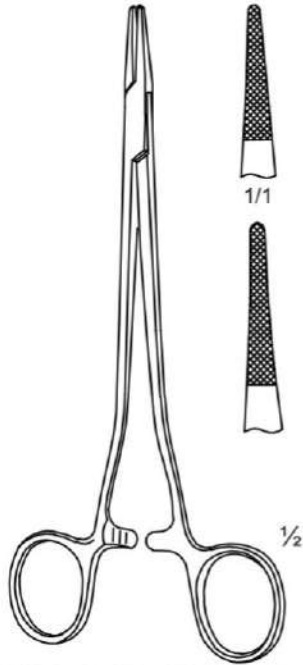

**MICRO-VASCULAR**



11-2701 15.0 cm

11-2702 18.0 cm  
11-2703 20.0 cm  
11-2704 23.0 cm

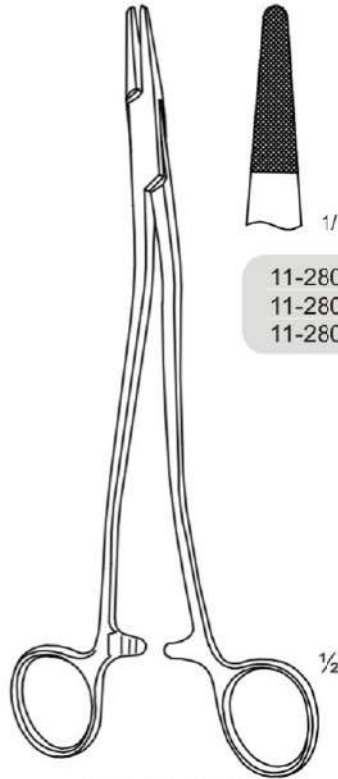

**WERTHEIM**



11-2801 20.0 cm  
11-2802 24.0 cm  
11-2803 30.0 cm

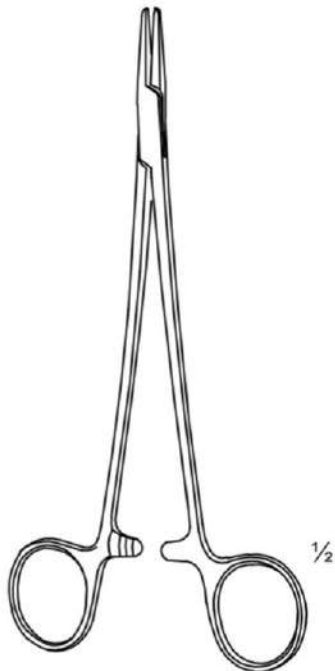

**DE BAKEY**  
Delicate, Diamond dust



11-2901 12.5 cm  
11-2902 14.5 cm  
11-2903 16.5 cm  
11-2904 18.0 cm  
11-2905 20.0 cm  
11-2906 23.0 cm  
11-2907 26.0 cm

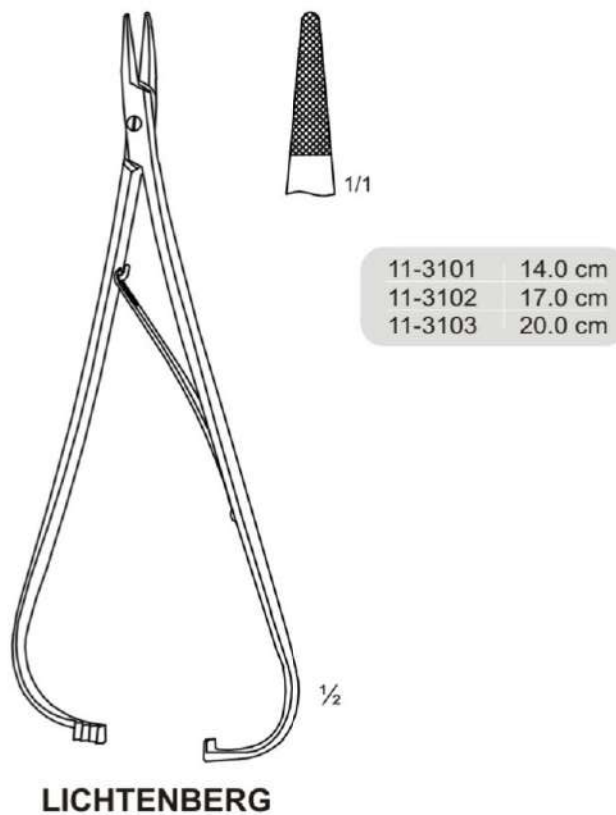
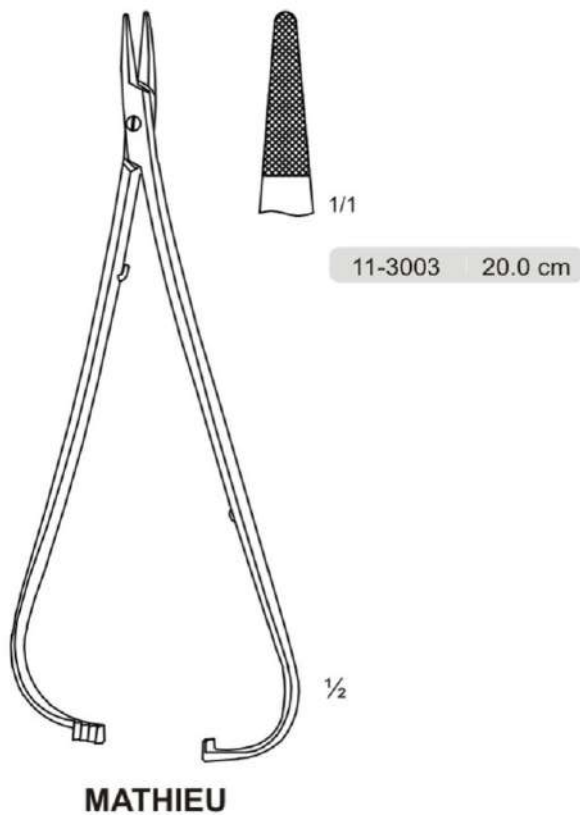
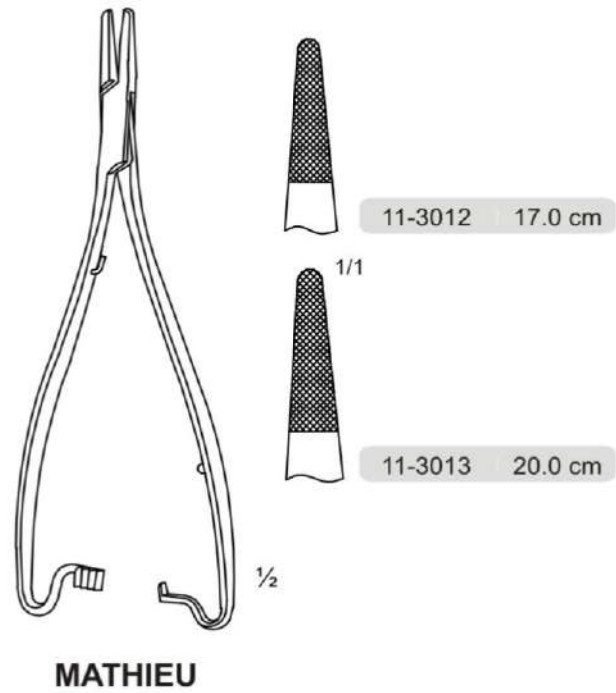
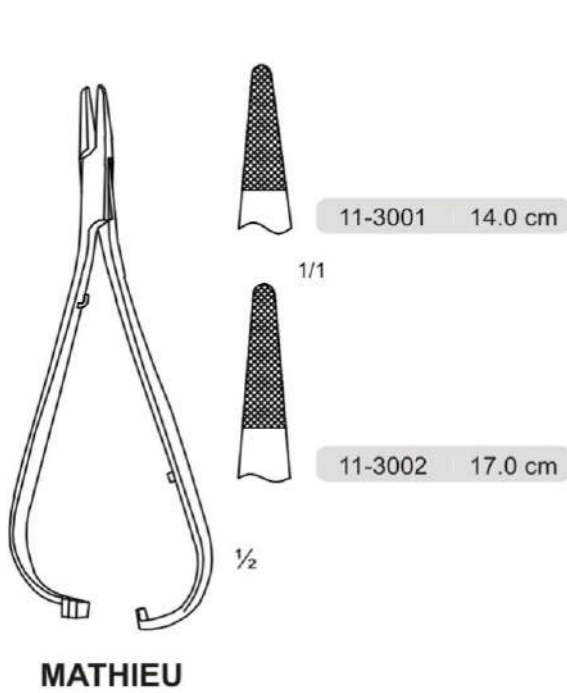

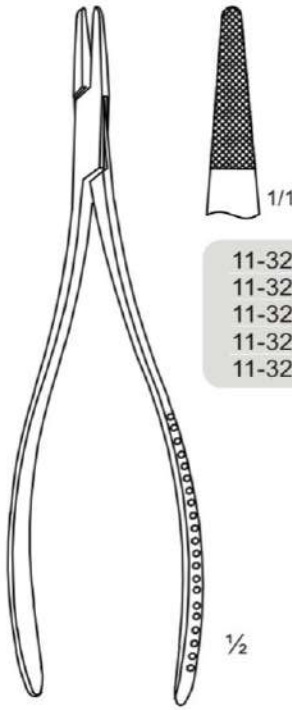

11-3201	14.0 cm
11-3202	16.0 cm
11-3203	18.0 cm
11-3204	20.0 cm
11-3205	23.0 cm

**LANGENBECK**

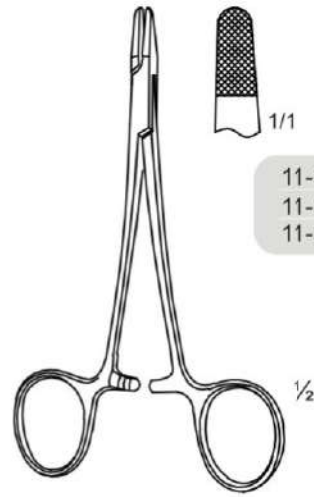

11-3301	13.0 cm
11-3302	16.0 cm
11-3303	18.0 cm

**WIRE TWISTER**  
Round Tip

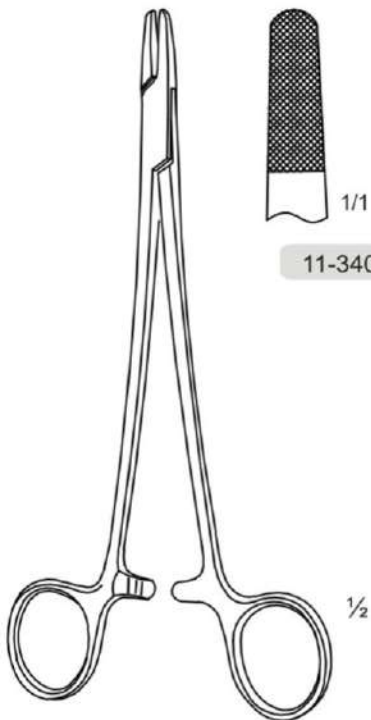

11-3400	18.5 cm
---------	---------

**WIRE TWISTER**  
heavy pattern  
Round Tip

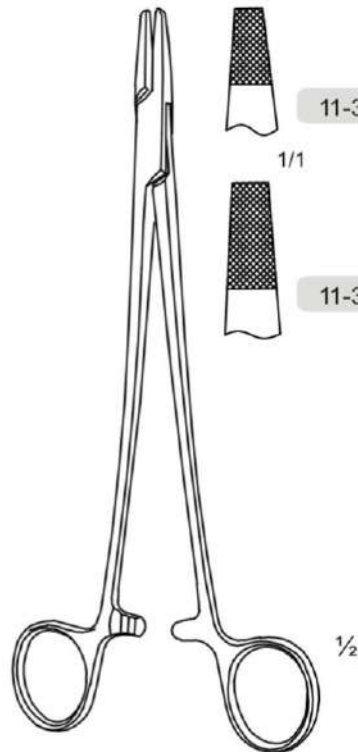

11-3501	16.0 cm
---------	---------

11-3502	20.0 cm
---------	---------

**WIRE TWISTER**  
Square Tip

Types of Tungsten-Carbide inserts for Needle Holders

All Tungsten-Carbide Needle Holders are available with difference Tungsten-Carbide inserts (A-B-C-D)

# GOLD

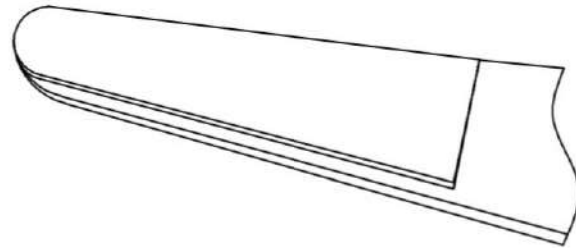

A Smooth

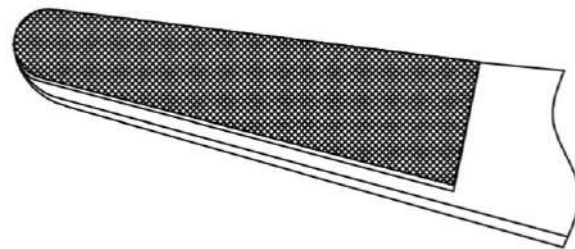

B Pyramidal-Form 0.2mm Serration

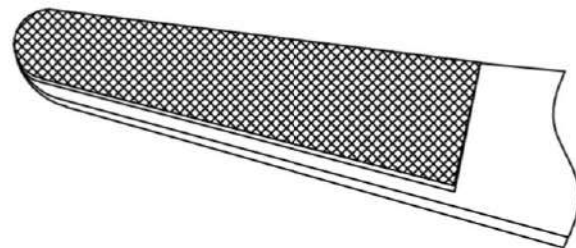

C Pyramidal-Form 0.3mm Serration

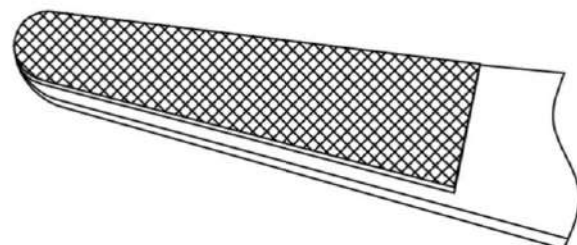

D Pyramidal-Form 0.4mm Serration



Please add the type symbols A-B-C-D to the article number

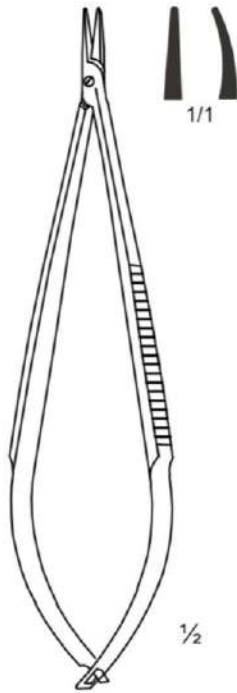

**CASTROVIEJO**  
Without lock

12-0101	14.0 cm	Straight
12-0102	18.0 cm	Straight
12-0103	21.0 cm	Straight
12-0104	22.0 cm	Straight
12-0111	14.0 cm	Curved
12-0112	18.0 cm	Curved
12-0113	21.0 cm	Curved
12-0114	22.0 cm	Curved

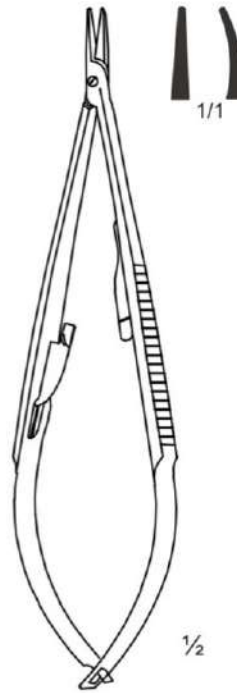

**CASTROVIEJO**  
With lock

12-0301	14.0 cm	Straight
12-0302	18.0 cm	Straight
12-0303	21.0 cm	Straight
12-0304	22.0 cm	Straight
12-0311	14.0 cm	Curved
12-0312	18.0 cm	Curved
12-0313	21.0 cm	Curved
12-0314	22.0 cm	Curved

Please add the type symbols A-B-C-D to the article number



**BARRAQUER**  
Without lock



12-1001	14.0 cm	Straight
12-1002	15.0 cm	Straight
12-1003	18.0 cm	Straight
12-1004	21.0 cm	Straight
12-1005	23.0 cm	Straight
12-1011	14.0 cm	Curved
12-1012	15.0 cm	Curved
12-1013	18.0 cm	Curved
12-1014	21.0 cm	Curved
12-1015	23.0 cm	Curved



12-1001	14.0 cm	Straight
12-1002	15.0 cm	Straight
12-1003	18.0 cm	Straight
12-1004	21.0 cm	Straight
12-1005	23.0 cm	Straight
12-1011	14.0 cm	Curved
12-1012	15.0 cm	Curved
12-1013	18.0 cm	Curved
12-1014	21.0 cm	Curved
12-1015	23.0 cm	Curved





Please add the type symbols A-B-C-D to the article number

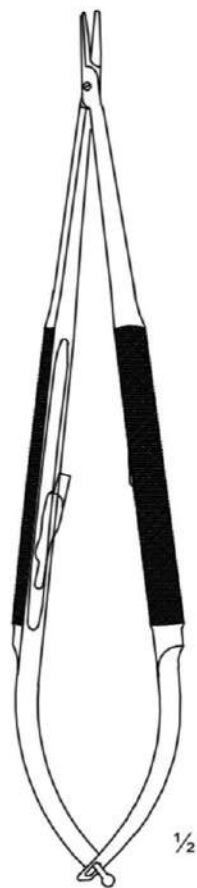

12-1201	14.0 cm	Straight
12-1202	15.0 cm	Straight
12-1203	18.0 cm	Straight
12-1204	21.0 cm	Straight
12-1205	23.0 cm	Straight
12-1211	14.0 cm	Curved
12-1212	15.0 cm	Curved
12-1213	18.0 cm	Curved
12-1214	21.0 cm	Curved
12-1215	23.0 cm	Curved



12-1301	14.0 cm	Straight
12-1302	15.0 cm	Straight
12-1303	18.0 cm	Straight
12-1304	21.0 cm	Straight
12-1305	23.0 cm	Straight
12-1311	14.0 cm	Curved
12-1312	15.0 cm	Curved
12-1313	18.0 cm	Curved
12-1314	21.0 cm	Curved
12-1315	23.0 cm	Curved

**BARRAQUER**  
With lock

Please add the type symbols A-B-C-D to the article number



**ARRUGA**

12-1401	14.0 cm	Straight/with little lock
12-1501	14.0 cm	Straight/with big lock
12-1411	14.0 cm	Curved/with little lock
12-1511	14.0 cm	Curved/with big lock

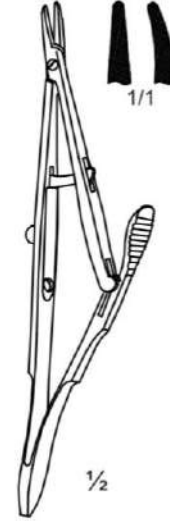

**KALT**

12-1601	14.0 cm	Straight
12-1611	14.0 cm	Curved

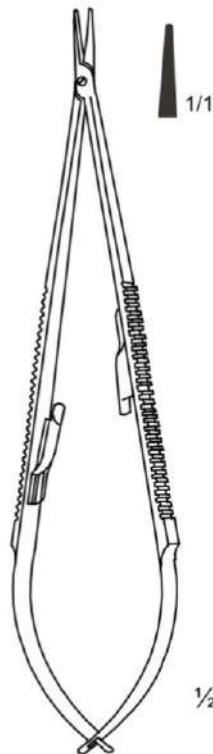

**CASTROVIEJO-RYDER**

12-1801	14.0 cm	Straight
12-1802	18.0 cm	Straight
12-1803	21.0 cm	Straight

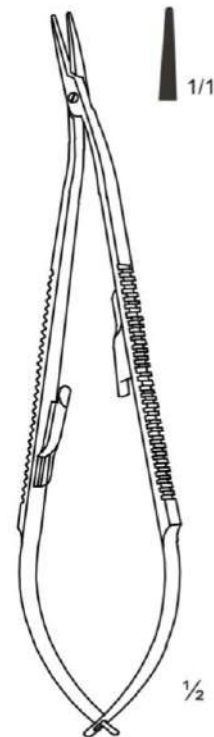

**CASTROVIEJO ANGLED**

12-1901	14.0 cm	Straight
12-1902	18.0 cm	Straight

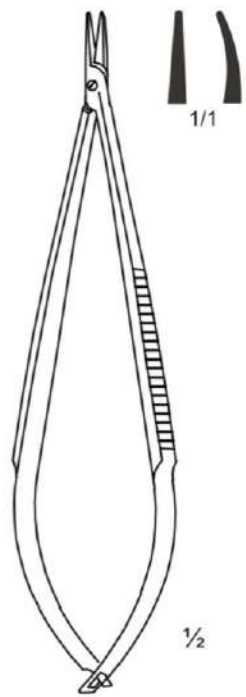

**CASTROVIEJO**  
Without lock

12-2001	14.0 cm	Straight
12-2002	18.0 cm	Straight
12-2003	21.0 cm	Straight
12-2004	22.0 cm	Straight
12-2011	14.0 cm	Curved
12-2012	18.0 cm	Curved
12-2013	21.0 cm	Curved
12-2014	22.0 cm	Curved

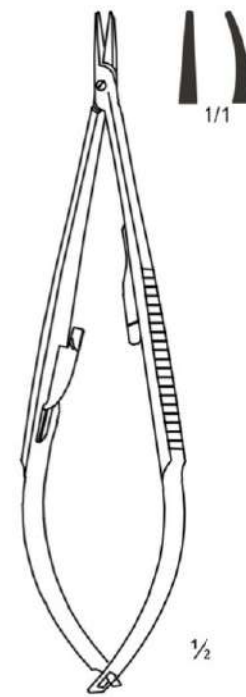

**CASTROVIEJO**  
With lock

12-2101	14.0 cm	Straight
12-2102	18.0 cm	Straight
12-2103	21.0 cm	Straight
12-2104	22.0 cm	Straight
12-2111	14.0 cm	Curved
12-2112	18.0 cm	Curved
12-2113	21.0 cm	Curved
12-0314	22.0 cm	Curved

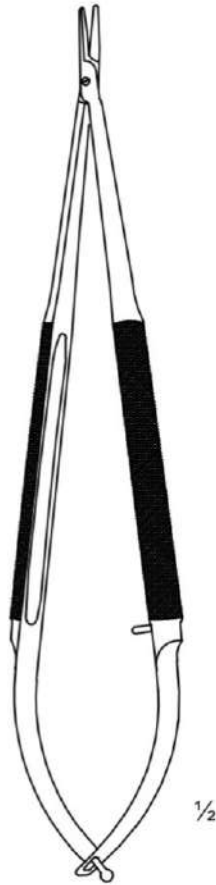

**BARRAQUER**  
Without lock



12-2201	14.0 cm	Straight
12-2202	15.0 cm	Straight
12-2203	18.0 cm	Straight
12-2204	21.0 cm	Straight
12-2205	23.0 cm	Straight
12-2211	14.0 cm	Curved
12-2212	15.0 cm	Curved
12-2213	18.0 cm	Curved
12-2214	21.0 cm	Curved
12-2215	23.0 cm	Curved



12-2301	14.0 cm	Straight
12-2302	15.0 cm	Straight
12-2303	18.0 cm	Straight
12-2304	21.0 cm	Straight
12-2305	23.0 cm	Straight
12-2311	14.0 cm	Curved
12-2312	15.0 cm	Curved
12-2313	18.0 cm	Curved
12-2314	21.0 cm	Curved
12-2315	23.0 cm	Curved

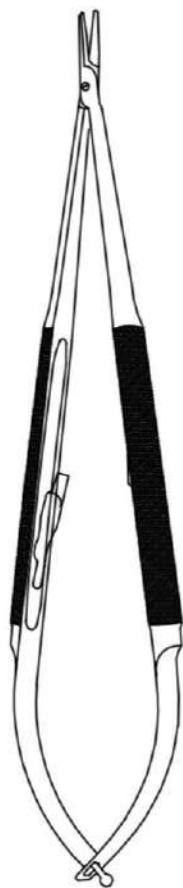

**BARRAQUER**  
With lock



1/1  
Delicate

12-2401	14.0 cm	Straight
12-2402	15.0 cm	Straight
12-2403	18.0 cm	Straight
12-2404	21.0 cm	Straight
12-2405	23.0 cm	Straight
12-2411	14.0 cm	Curved
12-2412	15.0 cm	Curved
12-2413	18.0 cm	Curved
12-2414	21.0 cm	Curved
12-2415	23.0 cm	Curved



1/1  
Micro

12-2501	14.0 cm	Straight
12-2502	15.0 cm	Straight
12-2503	18.0 cm	Straight
12-2504	21.0 cm	Straight
12-2505	23.0 cm	Straight
12-2511	14.0 cm	Curved
12-2512	15.0 cm	Curved
12-2513	18.0 cm	Curved
12-2514	21.0 cm	Curved
12-2515	23.0 cm	Curved

1/2

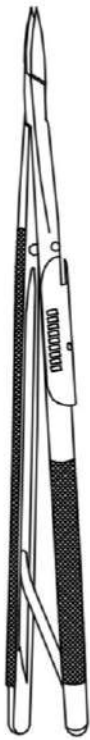

8/10

**CASTROVIEJO**  
Razor Blade Holder

12-2600 | 12.0 cm | Straight

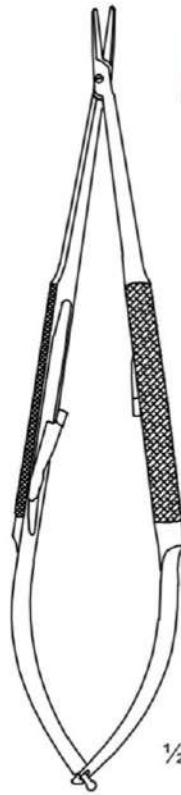

1/2



12-2701 | 21.0 cm | Straight  
12-2711 | 21.0 cm | Curved

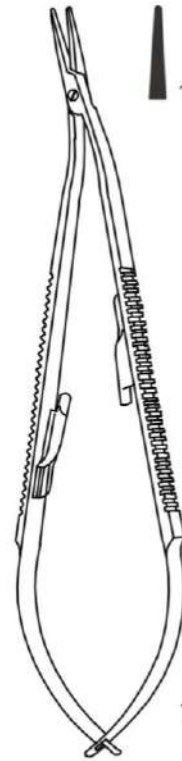

1/2



**CASTROVIEJO ANGLED**

12-2801 | 14.0 cm | Straight  
12-2802 | 18.0 cm | Straight





**Hemostatic Forceps**  
*Hemostatic Forceps*



**Intestinal Forceps**  
*Intestinal Forceps*

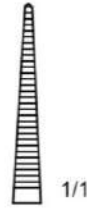

1/1

▶ 13-0101	12.5 cm	Straight
13-0102	14.0 cm	Straight
13-0103	18.0 cm	Straight

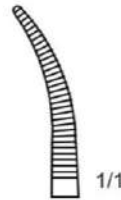

1/1

▶ 13-0111	12.5 cm	Curved
13-0112	14.0 cm	Curved
13-0113	18.0 cm	Curved

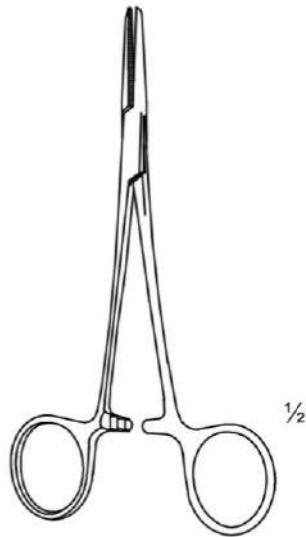

1/2

**HALSTED-MOSQUITO**

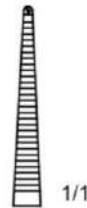

1/1

1X2 teeth

▶ 13-0201	12.5 cm	Straight
13-0202	14.0 cm	Straight
13-0203	18.0 cm	Straight



1/1

1X2 teeth

▶ 13-0211	12.5 cm	Curved
13-0212	14.0 cm	Curved
13-0213	18.0 cm	Curved

# Hemostatic Forceps

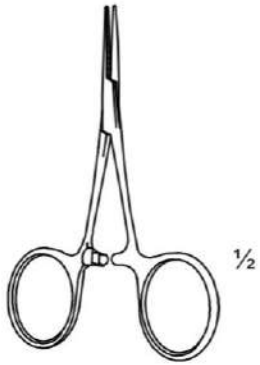

**HARTMANN-BABY-MOSQUITO**

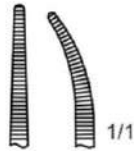

1X2 teeth

13-0301	9.5 cm	Straight
▶ 13-0311	9.5 cm	Curved

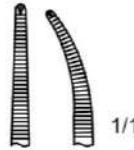

13-0401	9.5 cm	Straight
13-0411	9.5 cm	Curved

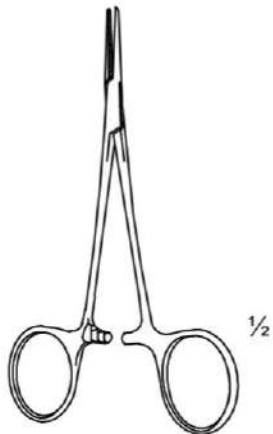

**MICRO-MOSQUITO**

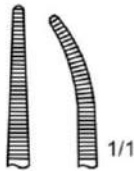

1X2 teeth

13-0501	12.5 cm	Straight
13-0511	12.5 cm	Curved

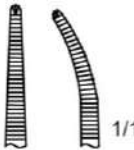

13-0601	12.5 cm	Straight
13-0611	12.5 cm	Curved

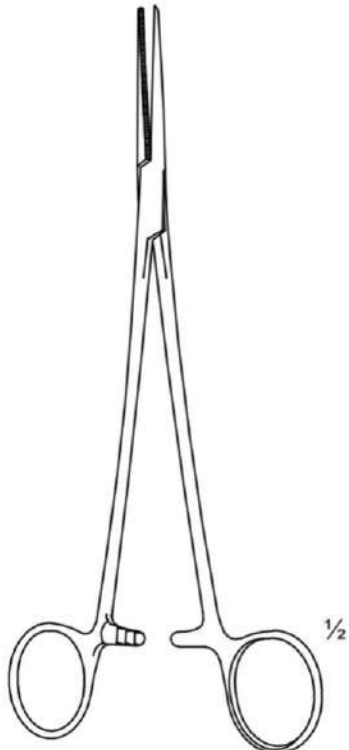

**HALSTED-MOSQUITO(HEISS)**

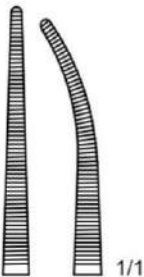

1X2 teeth

13-0701	21.0 cm	Straight
13-0711	21.0 cm	Curved

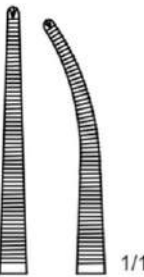

13-0801	21.0 cm	Straight
13-0811	21.0 cm	Curved

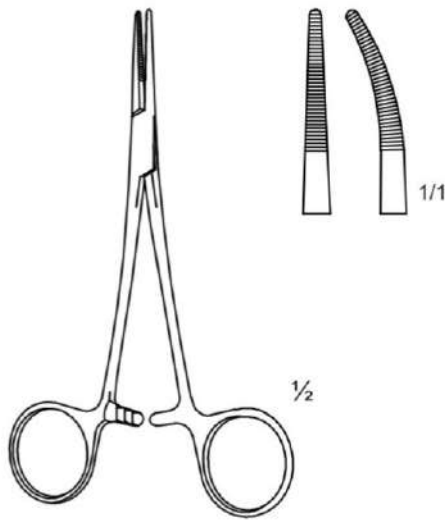

**PROVIDENCE-HOSPITAL**

13-0901	14.0 cm	Straight
13-0911	14.0 cm	Curved

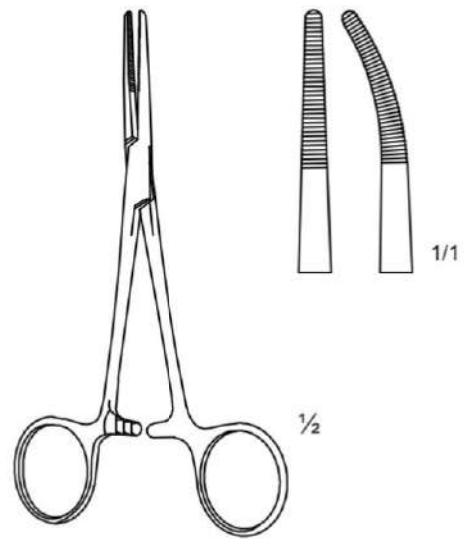

**KELLY**

▶ 13-1001	14.0 cm	Straight
▶ 13-1011	14.0 cm	Curved

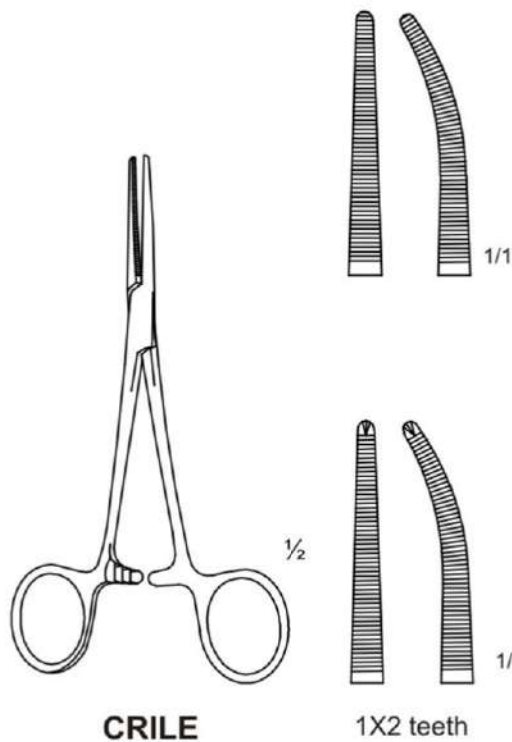

**CRILE**

1X2 teeth

▶ 13-1101	14.0 cm	Straight
▶ 13-1102	16.0 cm	Straight
▶ 13-1111	14.0 cm	Curved
▶ 13-1112	16.0 cm	Curved

13-1201	14.0 cm	Straight
13-1202	16.0 cm	Straight
13-1211	14.0 cm	Curved
13-1212	16.0 cm	Curved

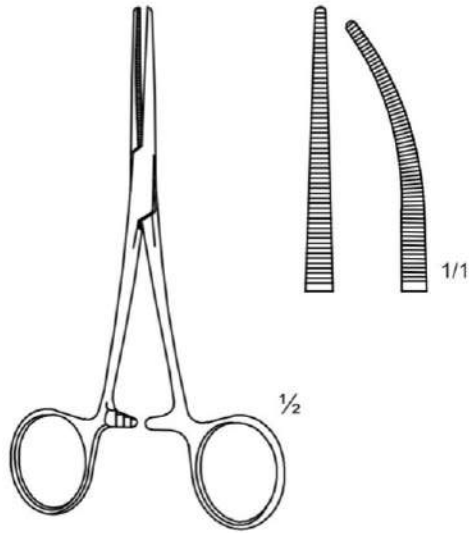

**PEAN-DELICATE**

13-1301	13.0 cm	Straight
13-1302	14.0 cm	Straight
13-1303	16.0 cm	Straight
13-1311	13.0 cm	Curved
13-1312	14.0 cm	Curved
13-1313	16.0 cm	Curved

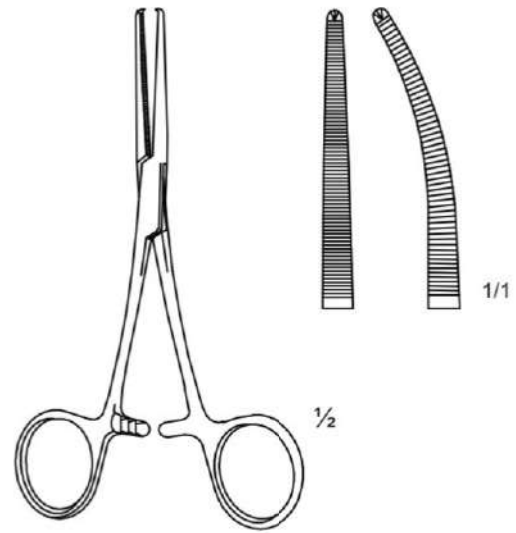

**KOCHER-DELICATE**

13-1401	13.0 cm	Straight
13-1402	14.0 cm	Straight
13-1403	16.0 cm	Straight
13-1411	13.0 cm	Curved
13-1412	14.0 cm	Curved
13-1413	16.0 cm	Curved

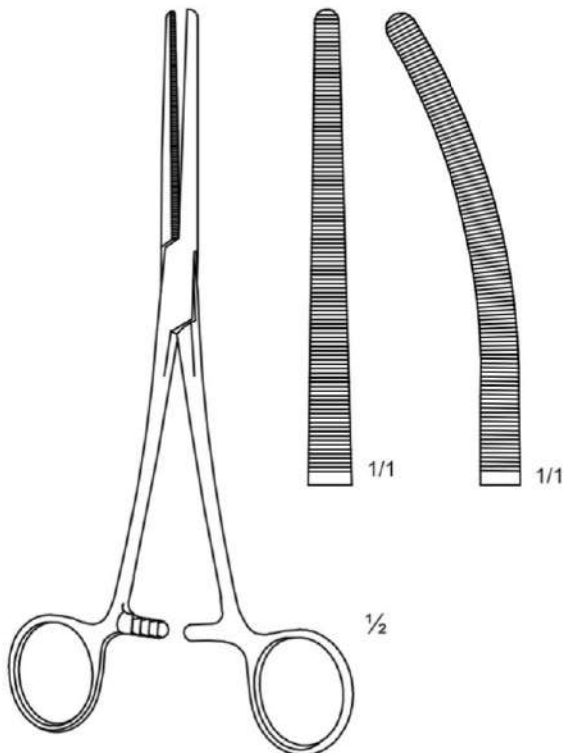

**ROCHESTER-PEAN**

▶ 13-1501	16.0 cm	Straight
▶ 13-1502	18.0 cm	Straight
▶ 13-1503	20.0 cm	Straight
▶ 13-1504	22.0 cm	Straight
▶ 13-1505	24.0 cm	Straight
▶ 13-1506	26.0 cm	Straight
▶ 13-1507	30.0 cm	Straight

▶ 13-1511	16.0 cm	Curved
▶ 13-1512	18.0 cm	Curved
▶ 13-1513	20.0 cm	Curved
▶ 13-1514	22.0 cm	Curved
▶ 13-1515	24.0 cm	Curved
▶ 13-1516	26.0 cm	Curved
▶ 13-1517	30.0 cm	Curved

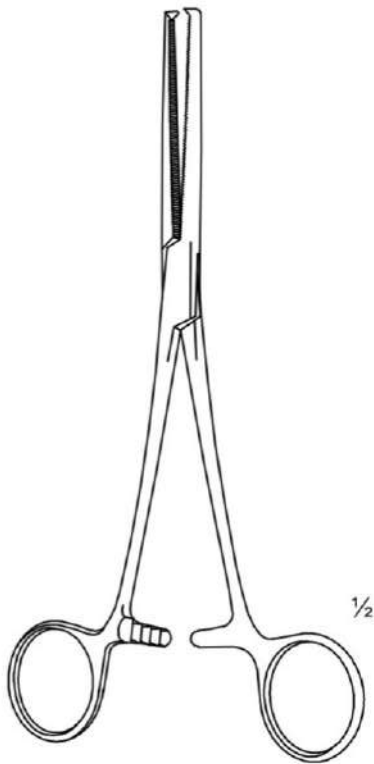

**OCHSNER-KOCHER**

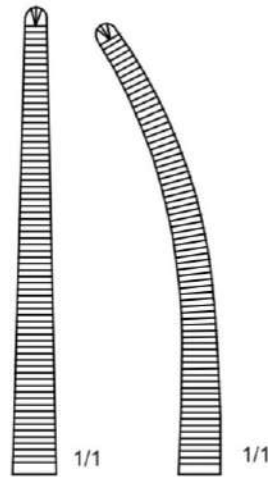

▶ 13-1601	16.0 cm	Straight
▶ 13-1602	18.0 cm	Straight
13-1603	20.0 cm	Straight
13-1604	22.0 cm	Straight
13-1605	24.0 cm	Straight
13-1606	26.0 cm	Straight
13-1607	30.0 cm	Straight

▶ 13-1611	16.0 cm	Curved
▶ 13-1612	18.0 cm	Curved
13-1613	20.0 cm	Curved
13-1614	22.0 cm	Curved
13-1615	24.0 cm	Curved
13-1616	26.0 cm	Curved
13-1617	30.0 cm	Curved

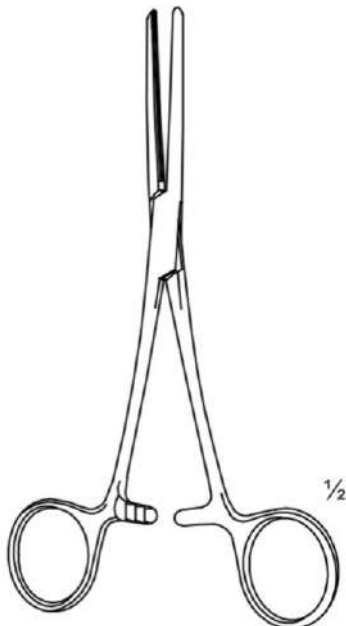

**ROCHESTER-CARMALT**

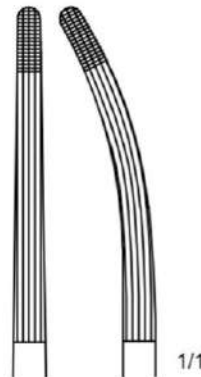

13-1701	16.0 cm	Straight
13-1702	18.0 cm	Straight
▶ 13-1703	20.0 cm	Straight
13-1711	16.0 cm	Curved
13-1712	18.0 cm	Curved
▶ 13-1713	20.0 cm	Curved



# Hemostatic Forceps

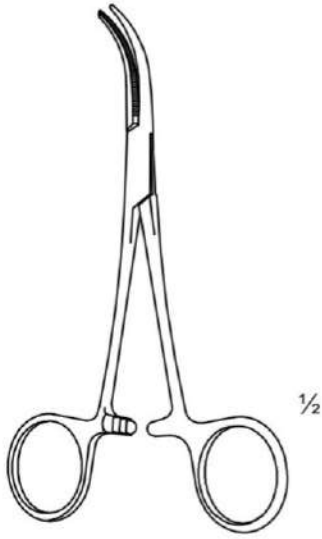

**DANDY**

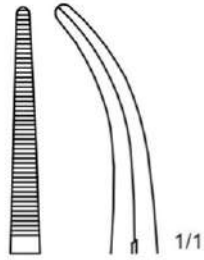

► 13-1800 | 14.0 cm | Curved

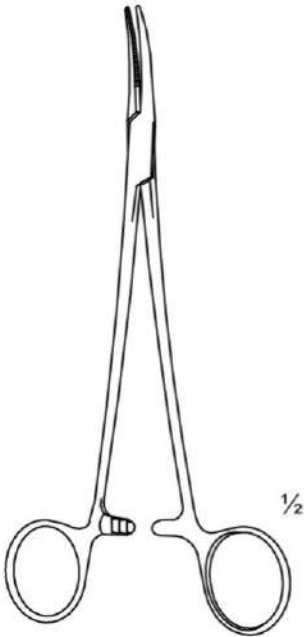

**SCHNIDT-SAWTELL**

► 13-1911 | 19.0 cm | Slightly Curved  
 ► 13-1912 | 19.0 cm | Full Curved

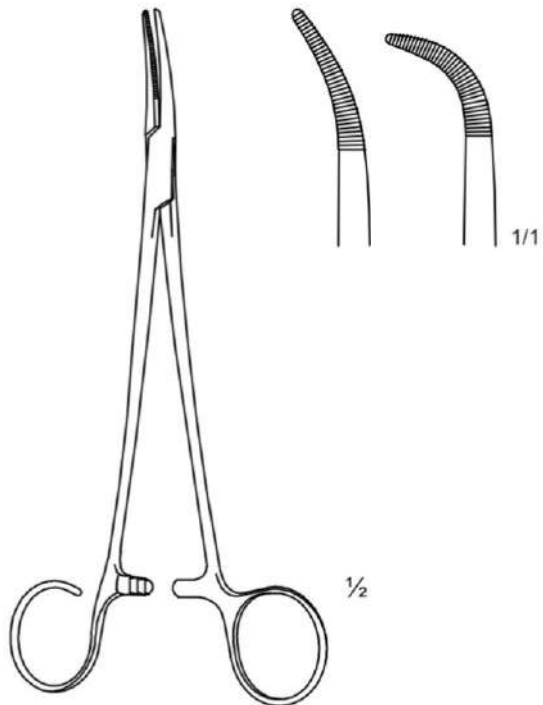
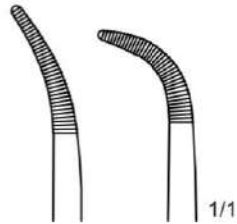

**SCHNIDT-SAWTELL  
with open ring**

13-1921 | 19.0 cm | Slightly Curved  
 13-1922 | 19.0 cm | Full Curved

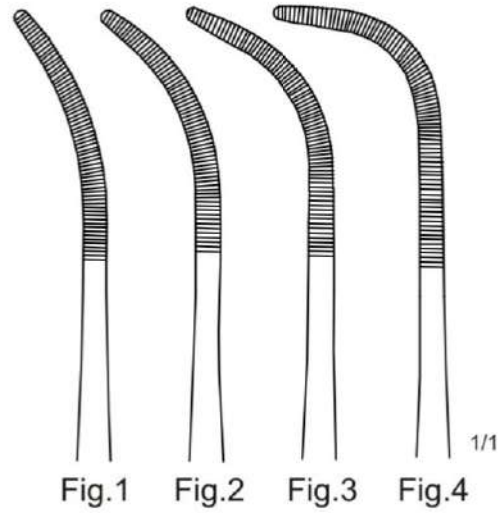
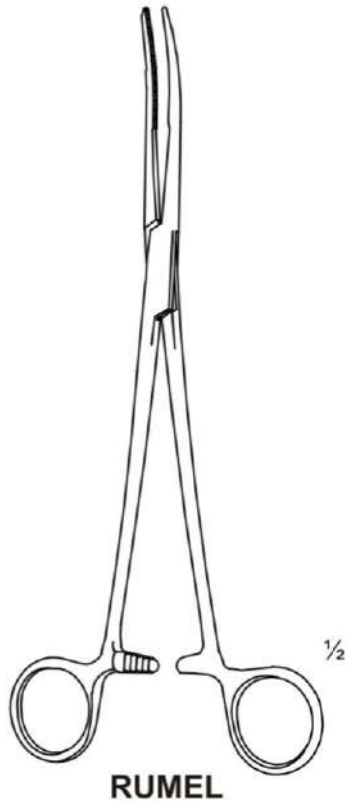

13-2011	23.0 cm	Fig.1
13-2012	23.0 cm	Fig.2
13-2013	23.0 cm	Fig.3
13-2014	23.0 cm	Fig.4

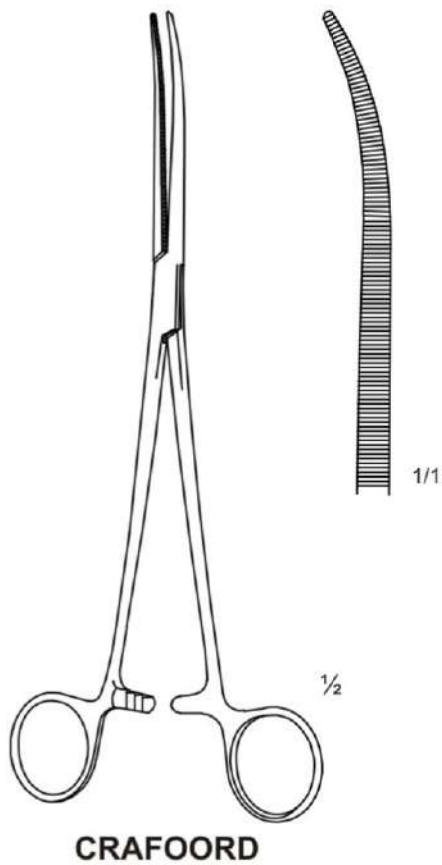

13-2100 24.0 cm Curved

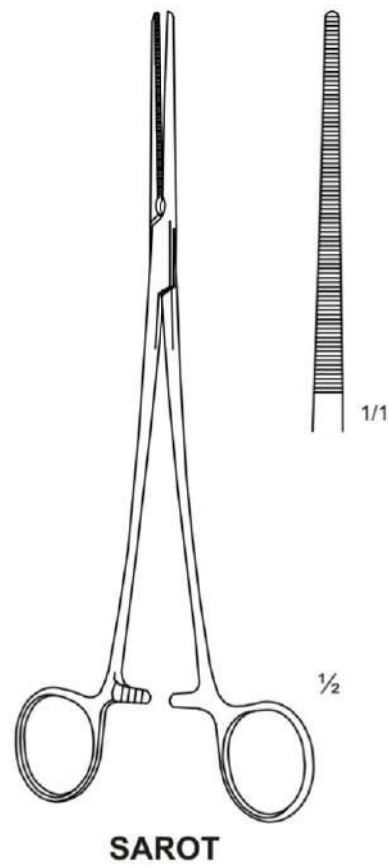

13-2200 24.0 cm Straight

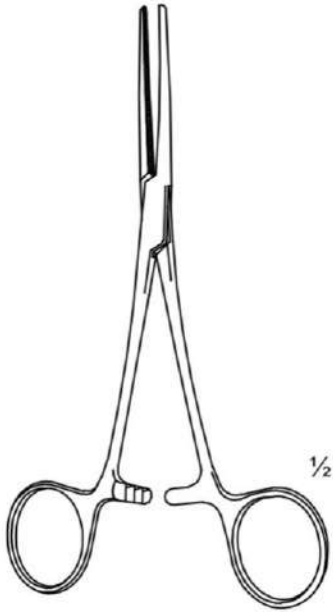

DIXON-LOVELACE

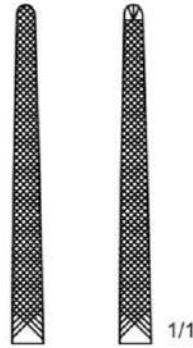

13-2301	15.0 cm	
13-2401	15.0 cm	1x2 teeth

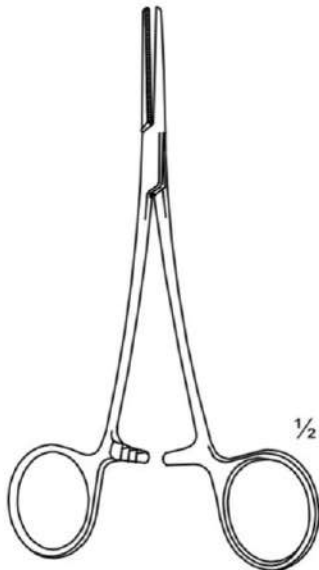

LERICHE

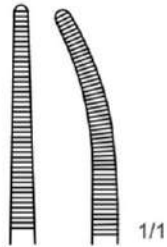

13-2501	15.0 cm	Straight
13-2511	15.0 cm	Curved

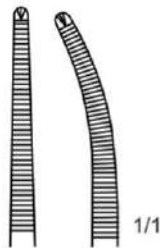

1X2 teeth

13-2601	15.0 cm	Straight
13-2611	15.0 cm	Curved

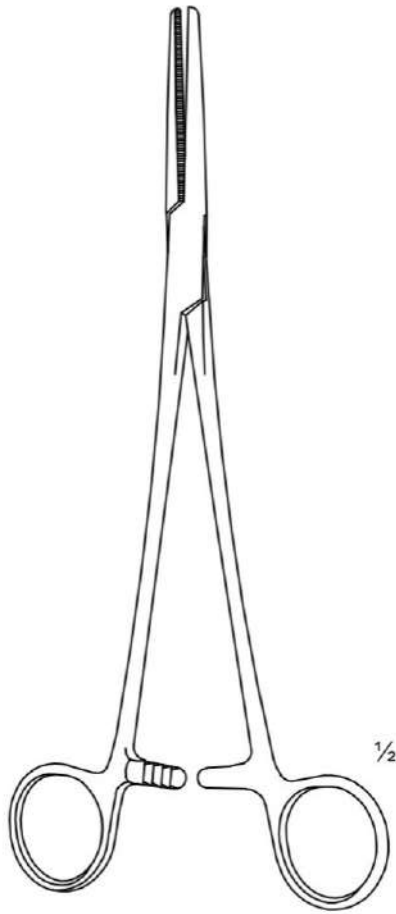

**ROBERTS**

1/2

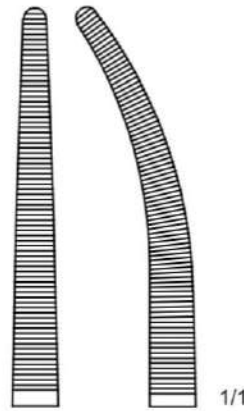

1/1

13-2701	22.0 cm	Straight
13-2711	22.0 cm	Curved

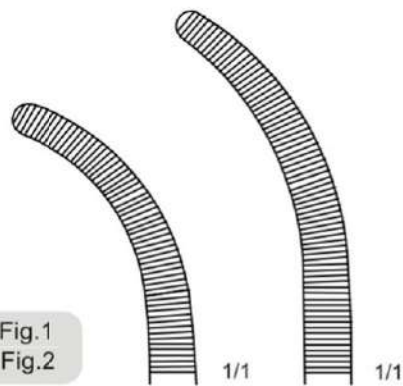

Fig.1

Fig.2

1/1

1/1

13-2811	23.0 cm	Fig.1
13-2812	23.0 cm	Fig.2

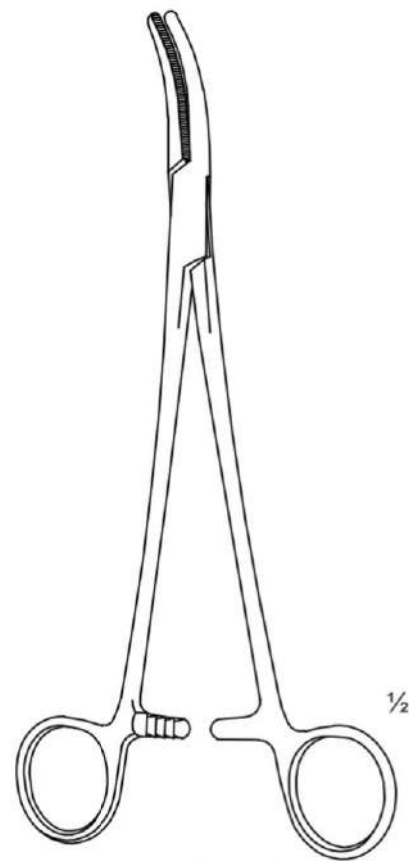

**MOYNIHAN**

1/2

# Hemostatic Forceps

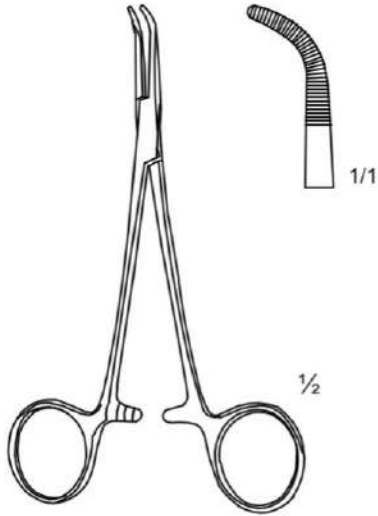

**BABY-ADSON**

13-2911 14.0 cm Curved

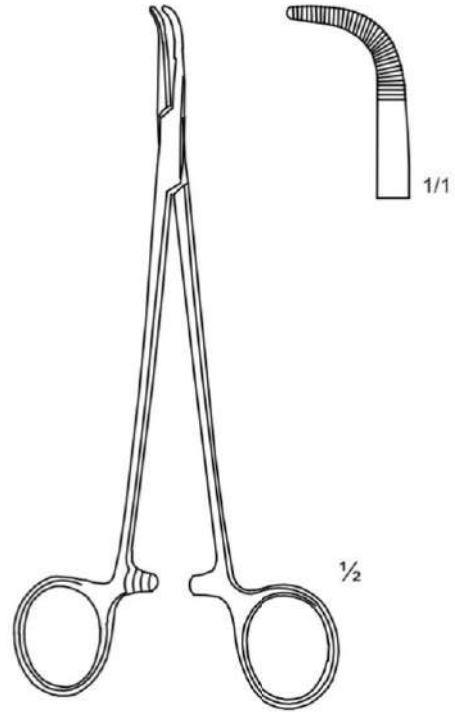

**BABY-ADISON**

13-2912 18.0 cm Curved

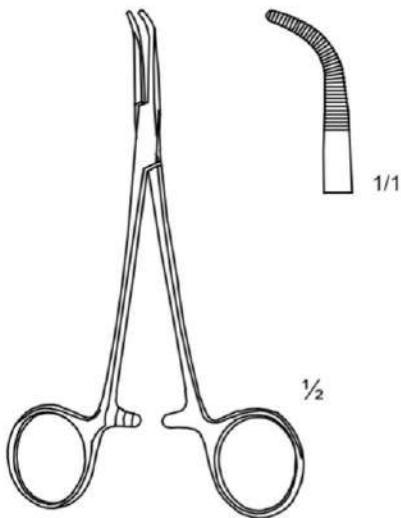

**MICRO-ADSON**

13-3000 14.0 cm Curved

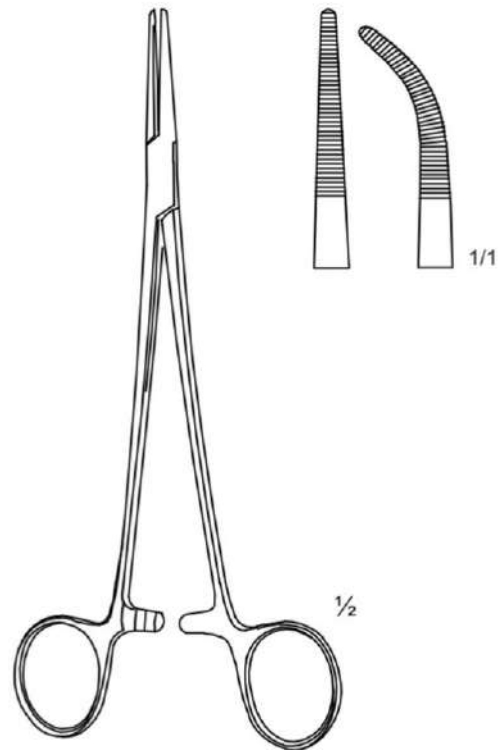

**ADSON**

13-3101 18.5 cm Straight  
13-3111 18.5 cm Curved

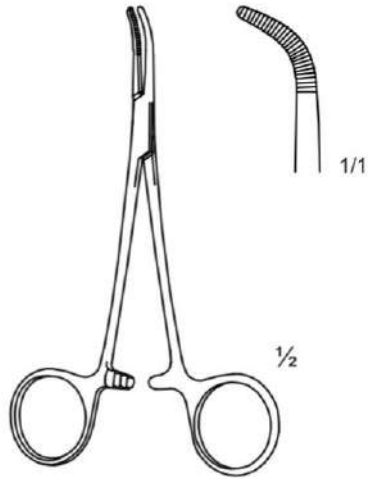

**BABY-MIXTER**

13-3211 14.0 cm Curved

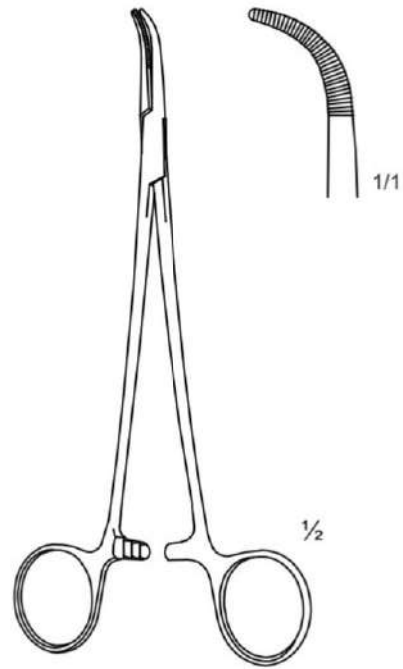

**BABY-MIXTER**

13-3212 18.0 cm Curved

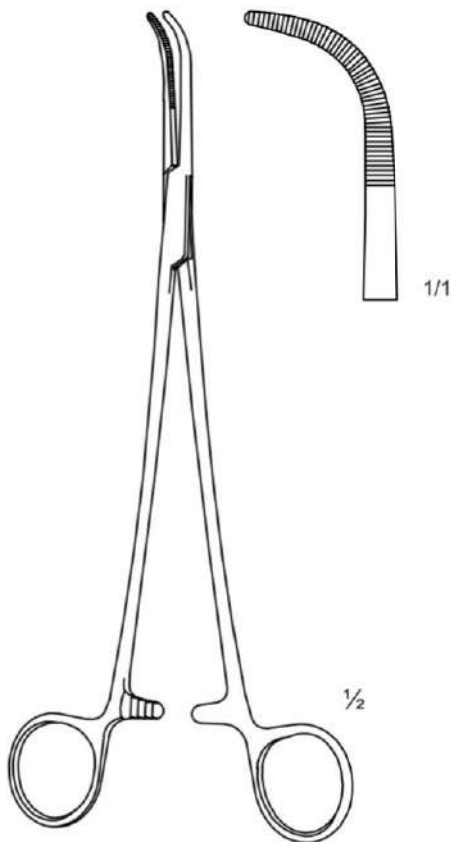

**MIXTER**

▶ 13-3300 22.0 cm Curved

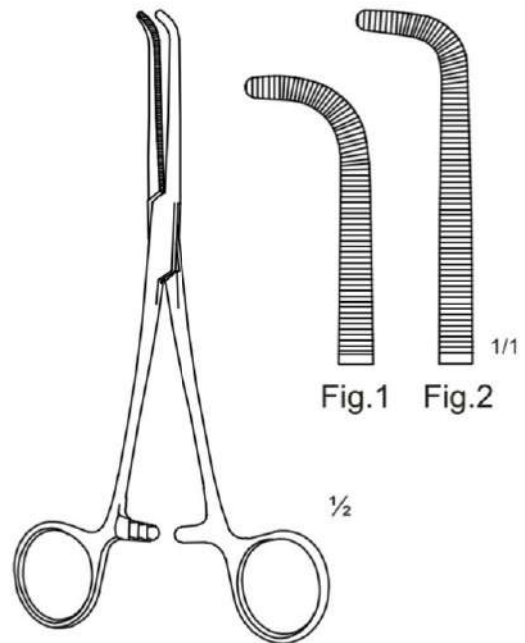

**MIXTER**

▶ 13-3411 15.5 cm Fig.1  
▶ 13-3412 19.0 cm Fig.2



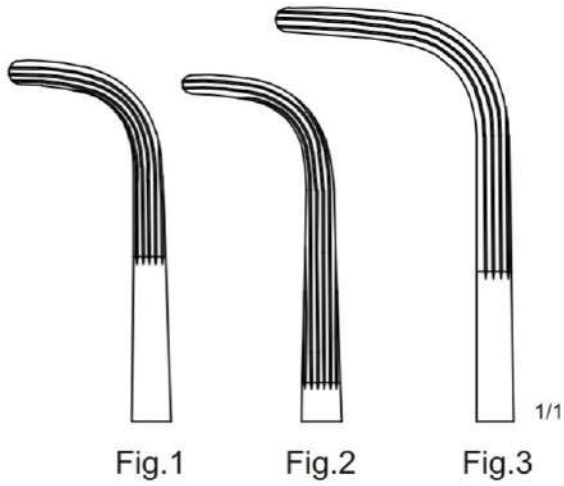

▶ 13-3511	22.0 cm	Fig.1
▶ 13-3512	25.5 cm	Fig.2
▶ 13-3513	28.0 cm	Fig.3

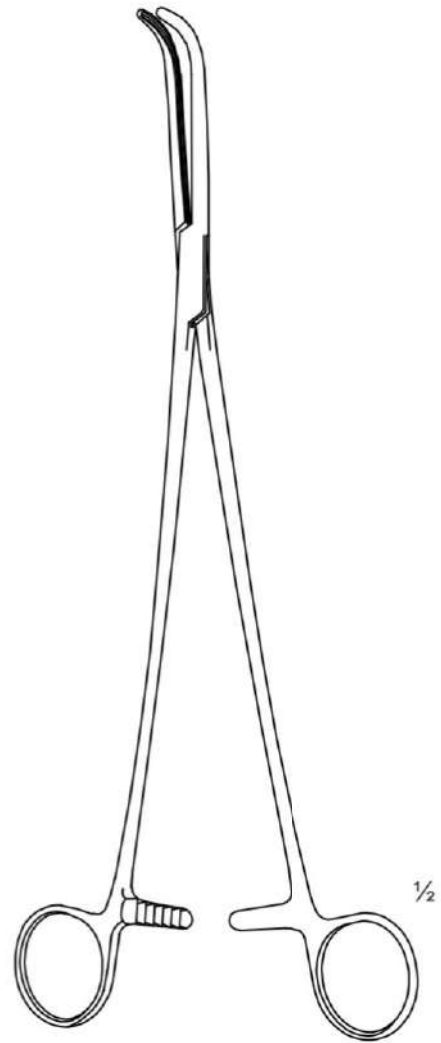

MIXTER



▶ 13-3521	14.0 cm
▶ 13-3522	16.0 cm
▶ 13-3523	18.0 cm
▶ 13-3524	19.0 cm

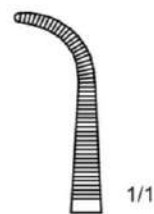
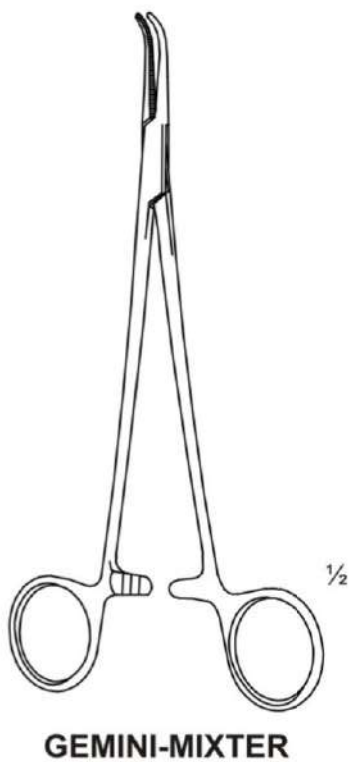

13-3611	13.0 cm	Curved
13-3612	14.0 cm	Curved
13-3613	16.0 cm	Curved
13-3614	18.0 cm	Curved
13-3615	20.0 cm	Curved
13-3616	23.0 cm	Curved
13-3617	25.0 cm	Curved
13-3618	28.0 cm	Curved

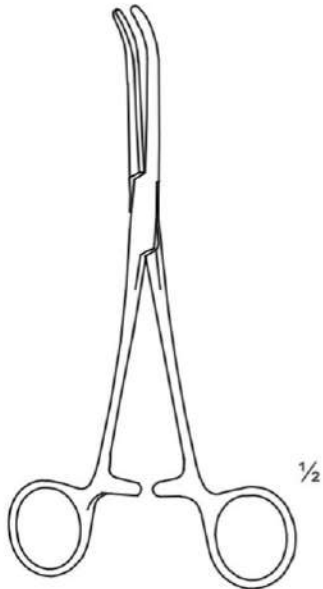

**MIXTER-O'SHAUGHNESSY**



13-3700 | 19.0 cm

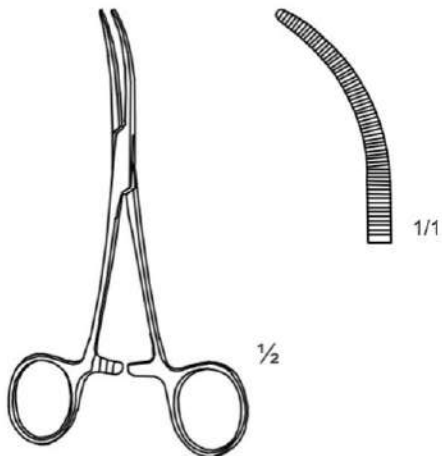

**BABY-OVERHOLT**

13-3800 | 13.5 cm

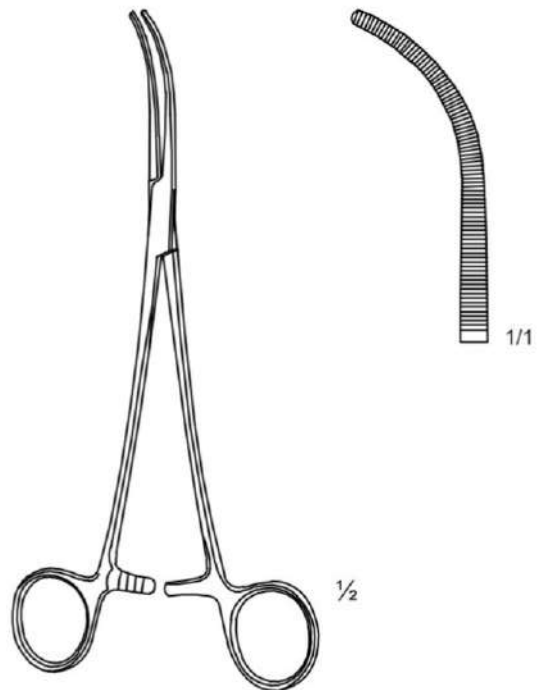

**OVERHOLTMIXTER**

13-3900 | 21.0 cm

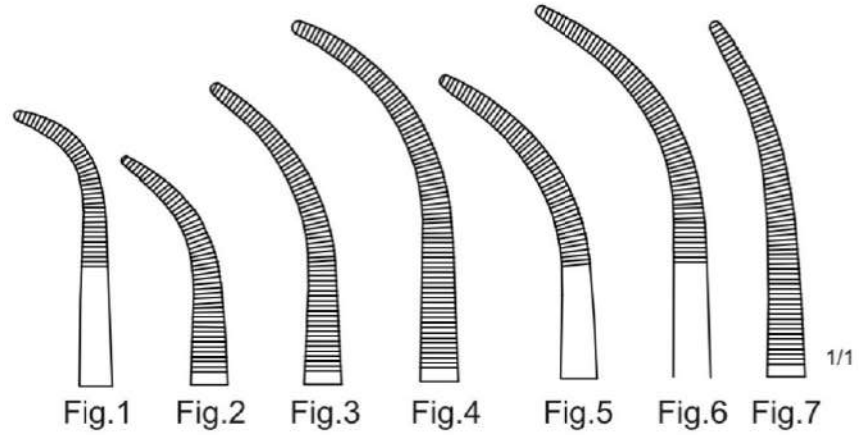
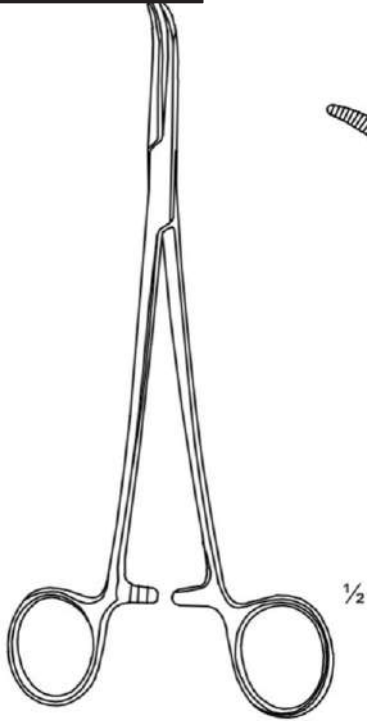

13-4011	21.0 cm	Fig.1
13-4012	21.0 cm	Fig.2
13-4013	21.0 cm	Fig.3
13-4014	21.0 cm	Fig.4
13-4015	21.0 cm	Fig.5
13-4016	21.0 cm	Fig.6
13-4017	21.0 cm	Fig.7

**OVERHOLT-GEISSENDOERFER**

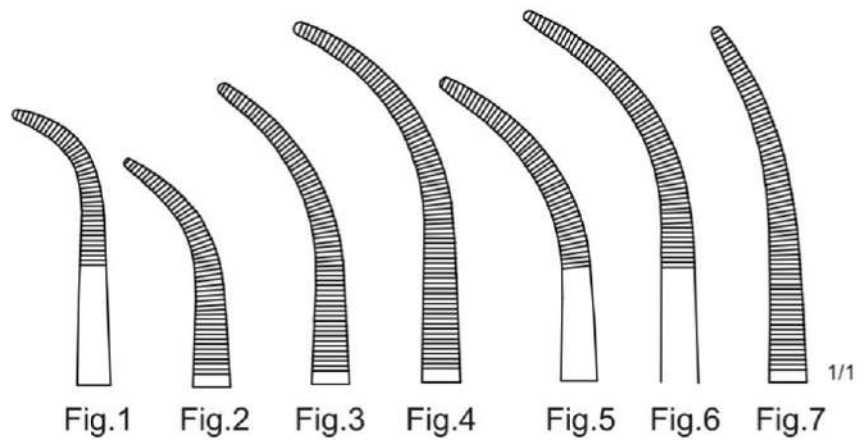
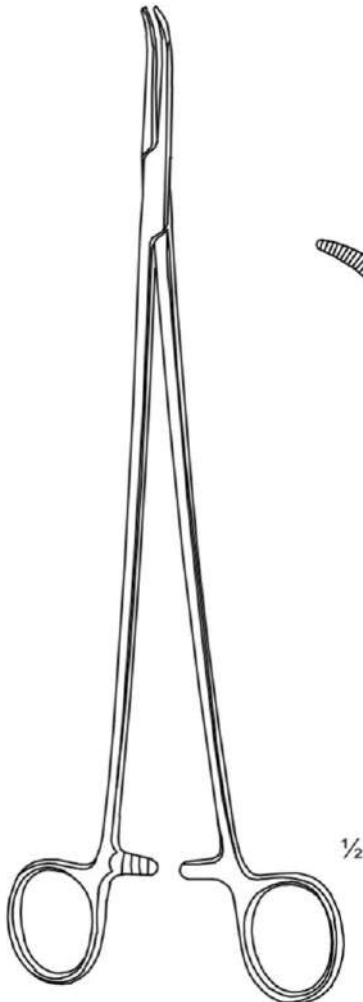

13-4021	30.0 cm	Fig.1
13-4022	30.0 cm	Fig.2
13-4023	30.0 cm	Fig.3
13-4024	30.0 cm	Fig.4
13-4025	30.0 cm	Fig.5
13-4026	30.0 cm	Fig.6
13-4027	30.0 cm	Fig.7

**OVERHOLT-GEISSENDOERFER**



# Hemostatic Forceps

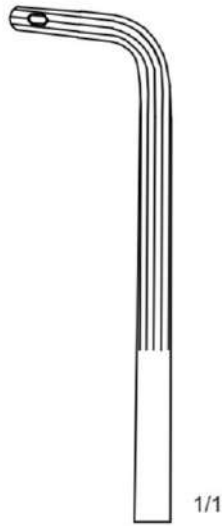
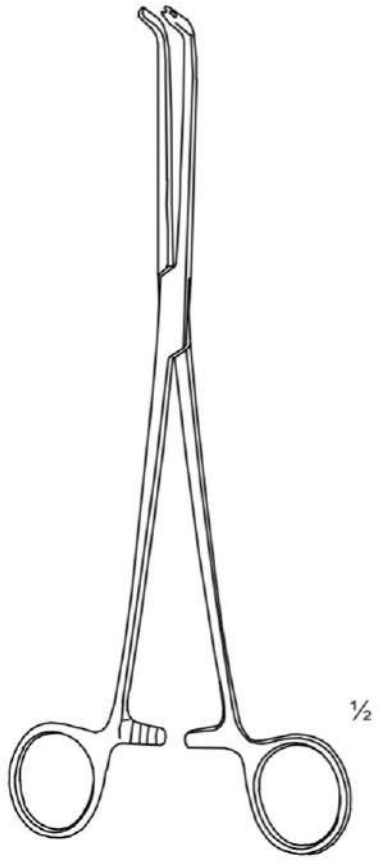

13-4100 | 24.0 cm

**FINOCHIETTO**

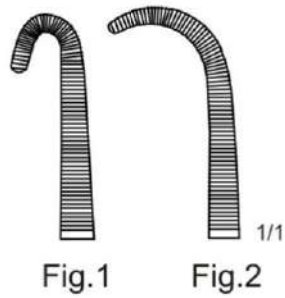

**NEGUS**  
 13-4211 19.0 cm Fig.1  
 13-4212 19.0 cm Fig.2

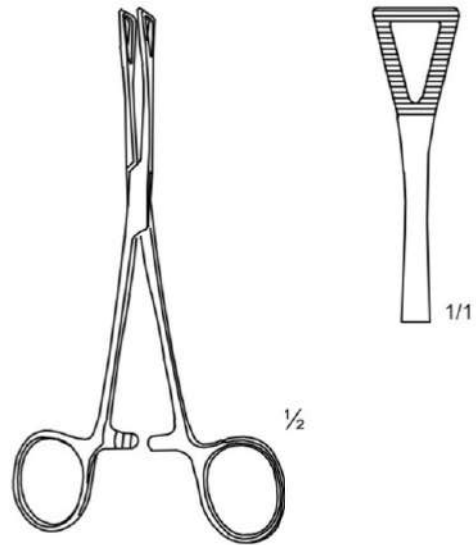

**PENNINGTON**  
 ▶ 13-4301 15.5 cm  
 ▶ 13-4302 20.0 cm

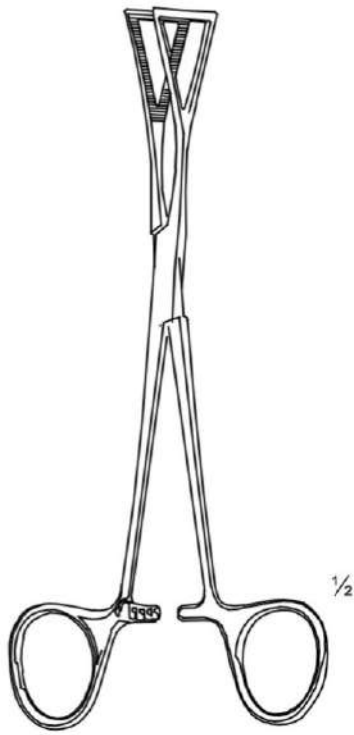

LOVELACE



13-4400 20.0 cm



TUBING

- ▶ 13-4501 15.0 cm
- ▶ 13-4502 18.0 cm
- ▶ 13-4503 20.0 cm

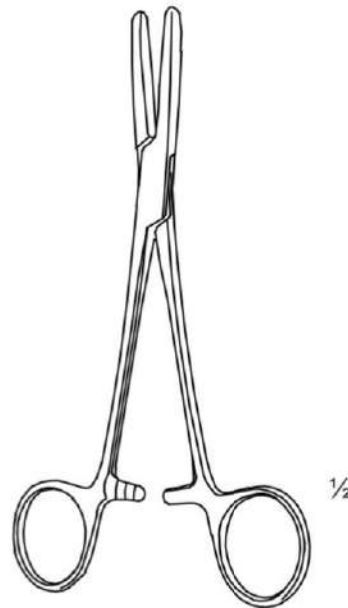

TUBING

13-4600 16.0 cm







1/2

**HOUSE-GELFOAM**

13-4701	16.0 cm
13-4702	22.0 cm



1/1



1/1

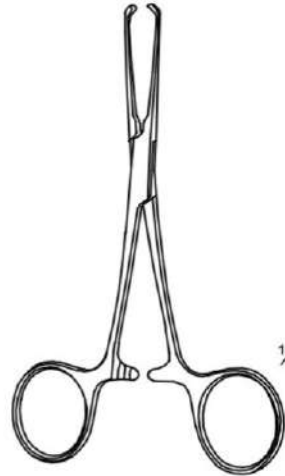

1/2

**BABY-ALLIS**

14-0101	12.5 cm
14-0102	14.0 cm



1/1

4 X 5 teeth

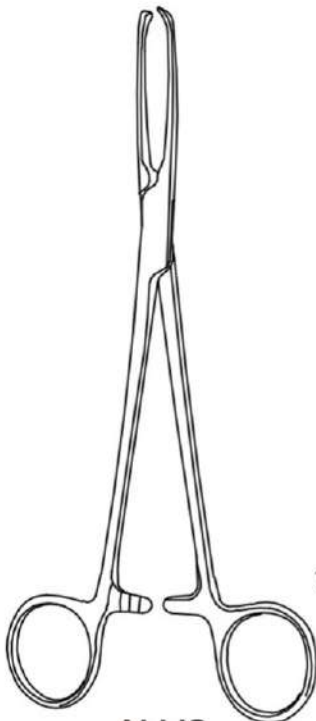

1/2

**ALLIS**



1/1

5 X 6 teeth

▶ 14-0201	15.0 cm	4 x 5 teeth
▶ 14-0202	15.0 cm	5 x 6 teeth
▶ 14-0203	19.0 cm	5 x 6 teeth
▶ 14-0204	25.0 cm	5 x 6 teeth

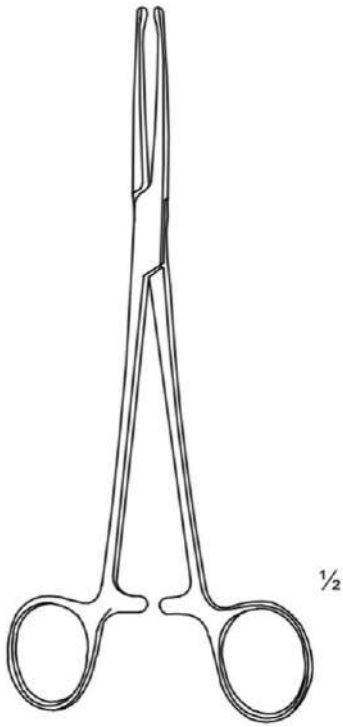

1/2

**JUDD-ALLIS**



1/1

3 X 4 teeth

14-0301	15.0 cm
▶ 14-0302	19.0 cm

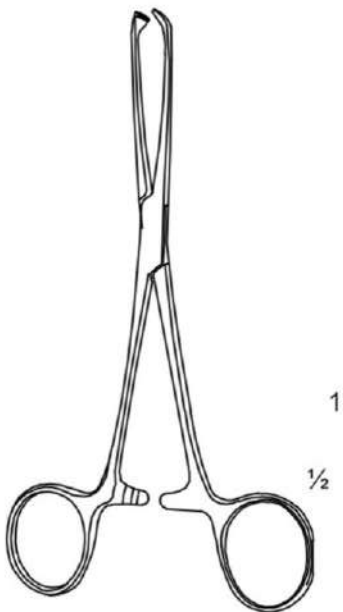

1/2

**ALLIS-ADAIR**

▶ 14-0400	15.0 cm
-----------	---------

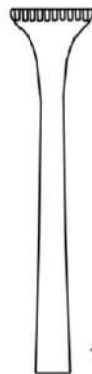

1/1

10 X 11 teeth

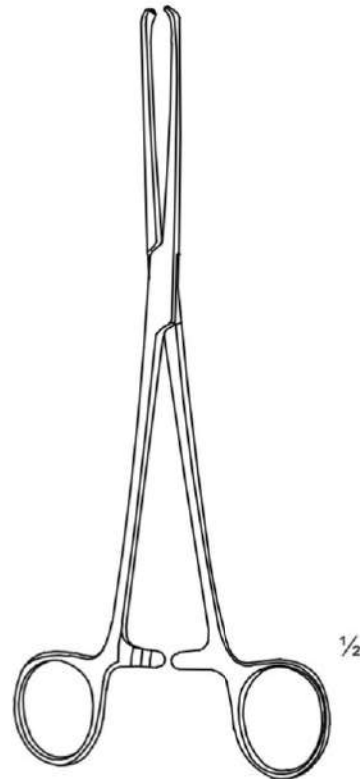

1/2

**THOMS-ALLIS**

▶ 14-0500	20.0 cm
-----------	---------



1/1

8 X 9 teeth

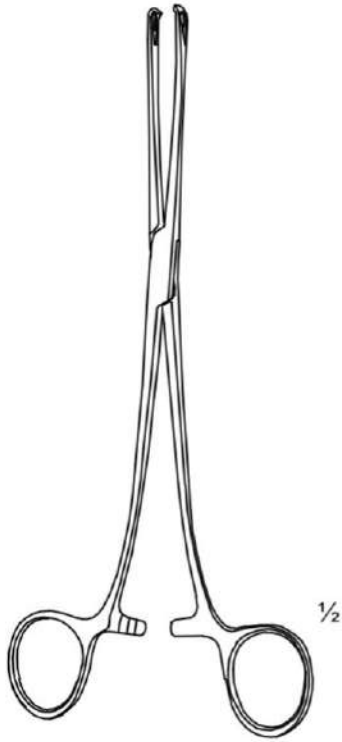

**LOCKWOOD**

14-0600 20.0 cm

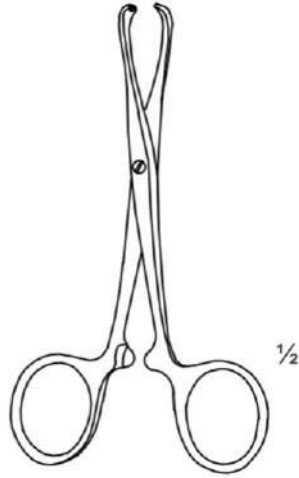

**TUFFIER**

14-0700 13.0 cm

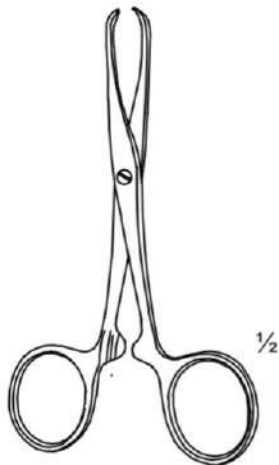
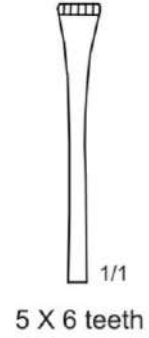

**CHAPUT**

14-0800 13.0 cm

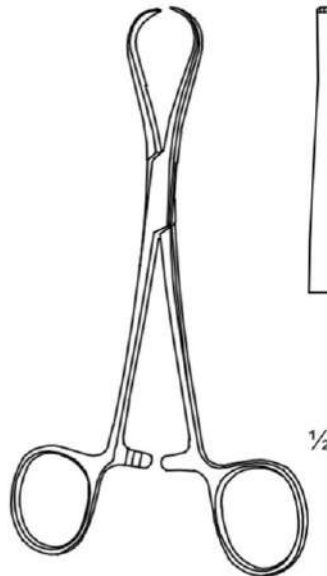

**JACKSON**

14-0900 14.5 cm

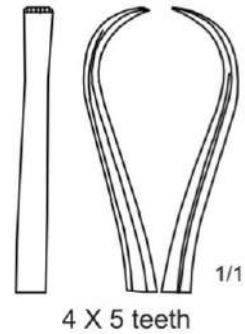

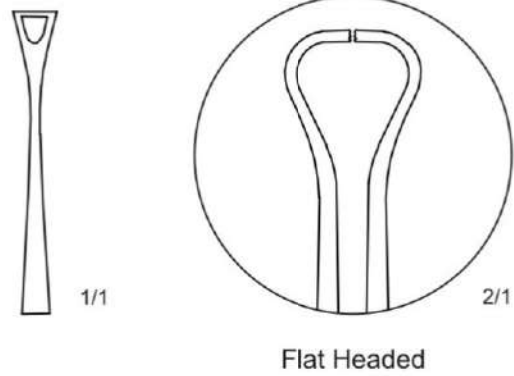
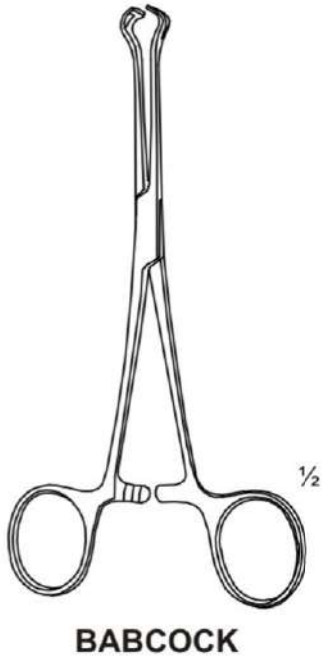

▶ 14-1001	16.0 cm	
▶ 14-1002	18.0 cm	
▶ 14-1003	20.0 cm	
▶ 14-1004	24.0 cm	
▶ 14-1100	23.0 cm	Flat Headed

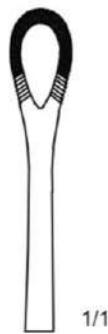
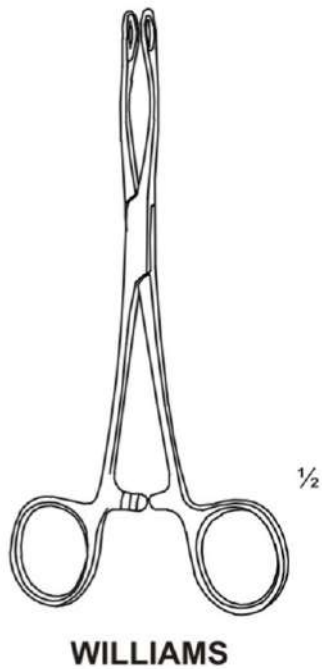

▶ 14-1201	16.0 cm
▶ 14-1202	20.0 cm

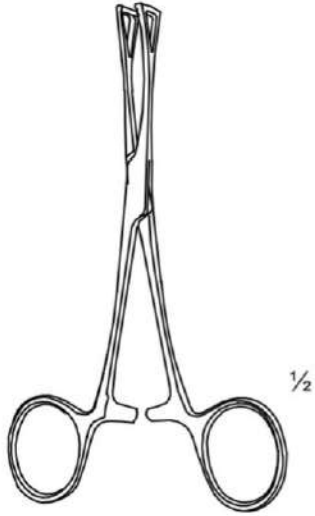

**COLLIN**



14-1300 14.0 cm

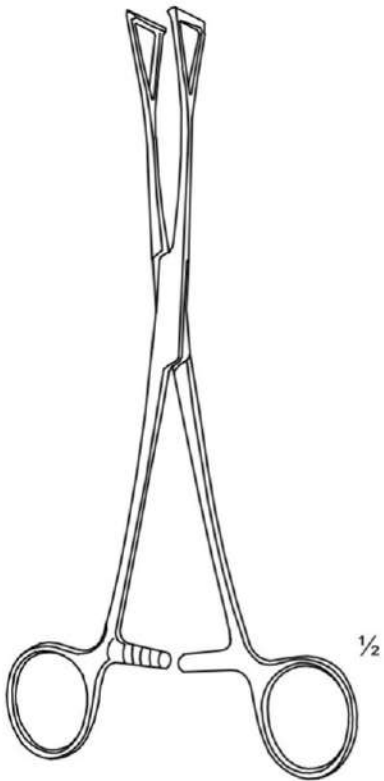

**DUVAL**

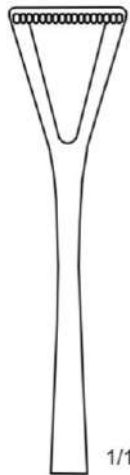

14-1401 20.0 cm  
14-1402 23.0 cm

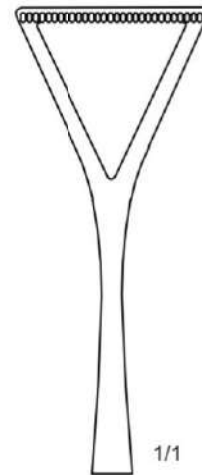

14-1501 20.0 cm  
14-1502 23.0 cm

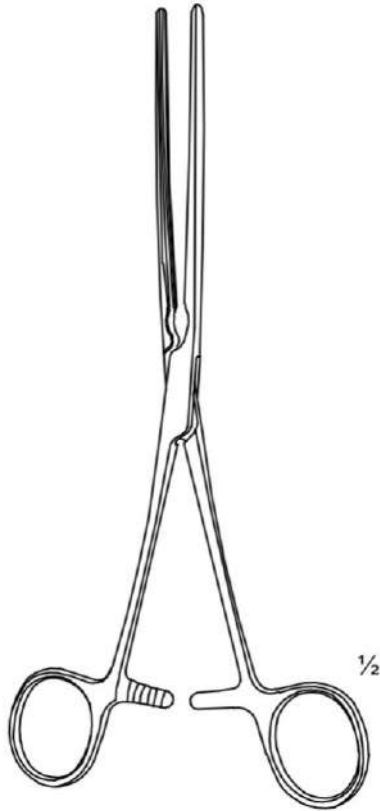

**KOCHER**

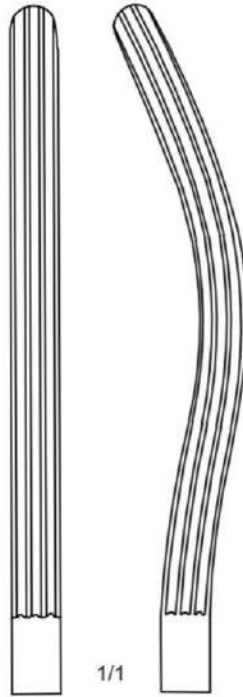

▶ 14-1601	22.0 cm	Straight
14-1602	25.0 cm	Straight
14-1603	28.0 cm	Straight
▶ 14-1611	22.0 cm	Curved
14-1612	25.0 cm	Curved
14-1613	28.0 cm	Curved

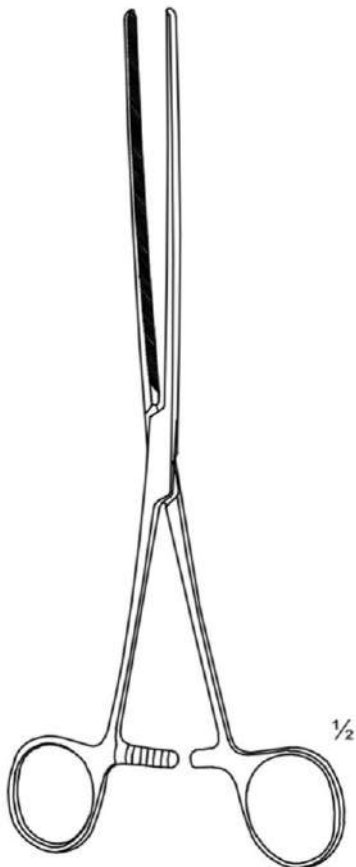

**DOYEN**



▶ 14-1602	25.0 cm	Straight
▶ 14-1603	28.0 cm	Straight
14-1611	22.0 cm	Curved
▶ 14-1612	25.0 cm	Curved



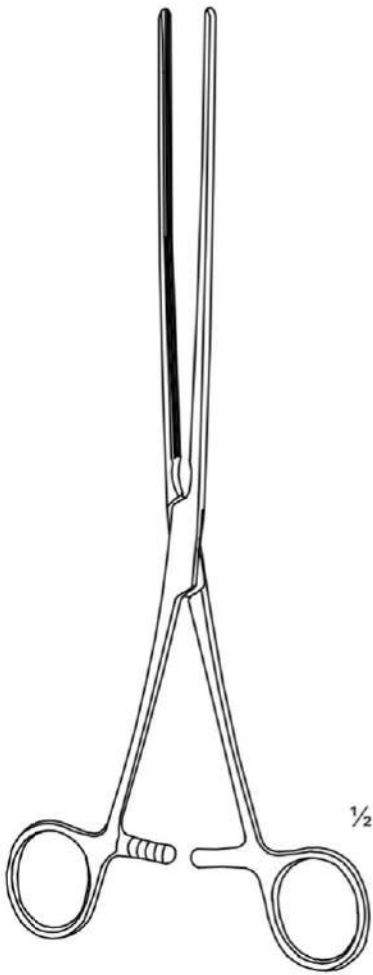

**MAYO-ROBSON**

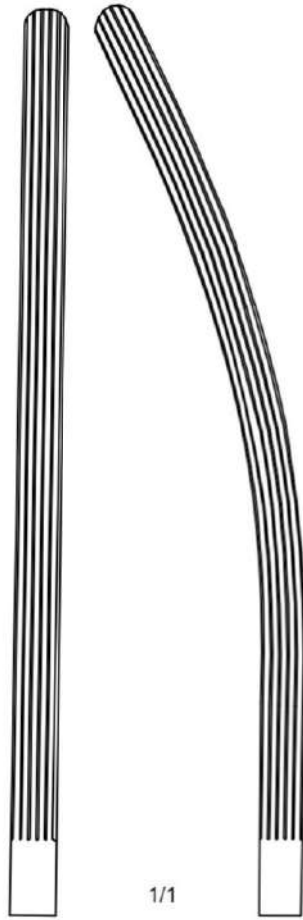

14-1801	21.0 cm	Straight
14-1802	23.0 cm	Straight
14-1803	25.0 cm	Straight
14-1811	21.0 cm	Curved
14-1812	23.0 cm	Curved
14-1813	25.0 cm	Curved

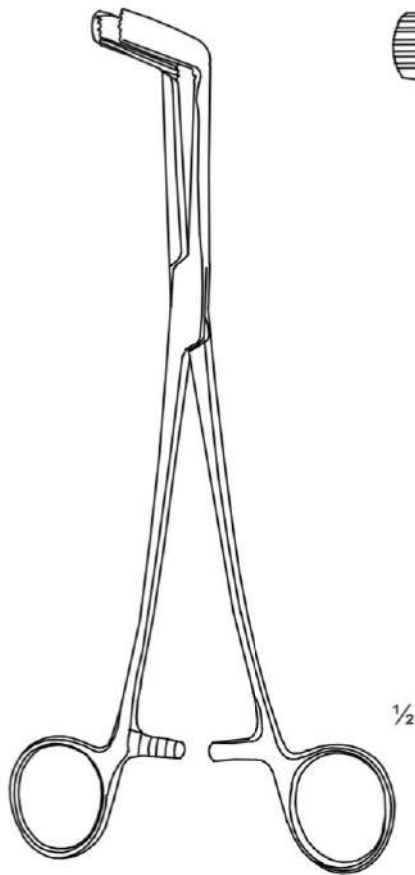

1/2

**WERTHEIM-CULLEN**

1/1

14-2000 23.0 cm

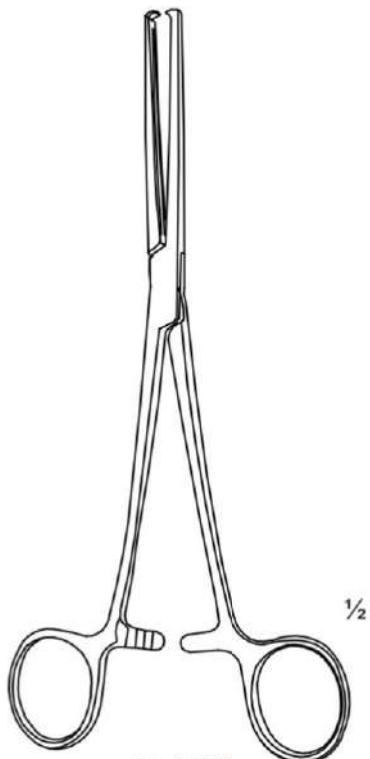

1/2

**ALLEN**



1/1

14-2101 15.0 cm  
▶ 14-2102 20.0 cm



**BAINBRIDGE**



▶ 14-2201	15.0 cm	Straight
▶ 14-2202	18.0 cm	Straight
▶ 14-2211	15.0 cm	Curved
▶ 14-2212	18.0 cm	Curved

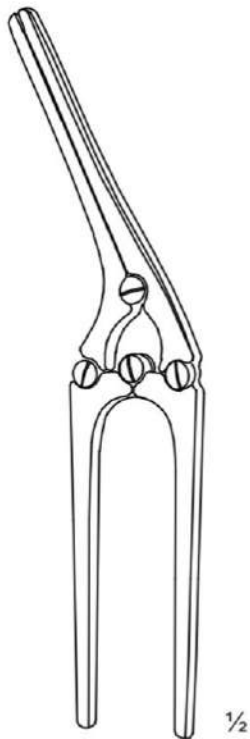

**PAYR**



With pin

▶ 14-2301	15.0 cm	without pin
▶ 14-2302	21.0 cm	without pin
▶ 14-2303	29.0 cm	without pin
▶ 14-2304	35.0 cm	without pin
▶ 14-2311	15.0 cm	with pin
▶ 14-2312	21.0 cm	with pin
▶ 14-2313	29.0 cm	with pin
▶ 14-2314	35.0 cm	with pin

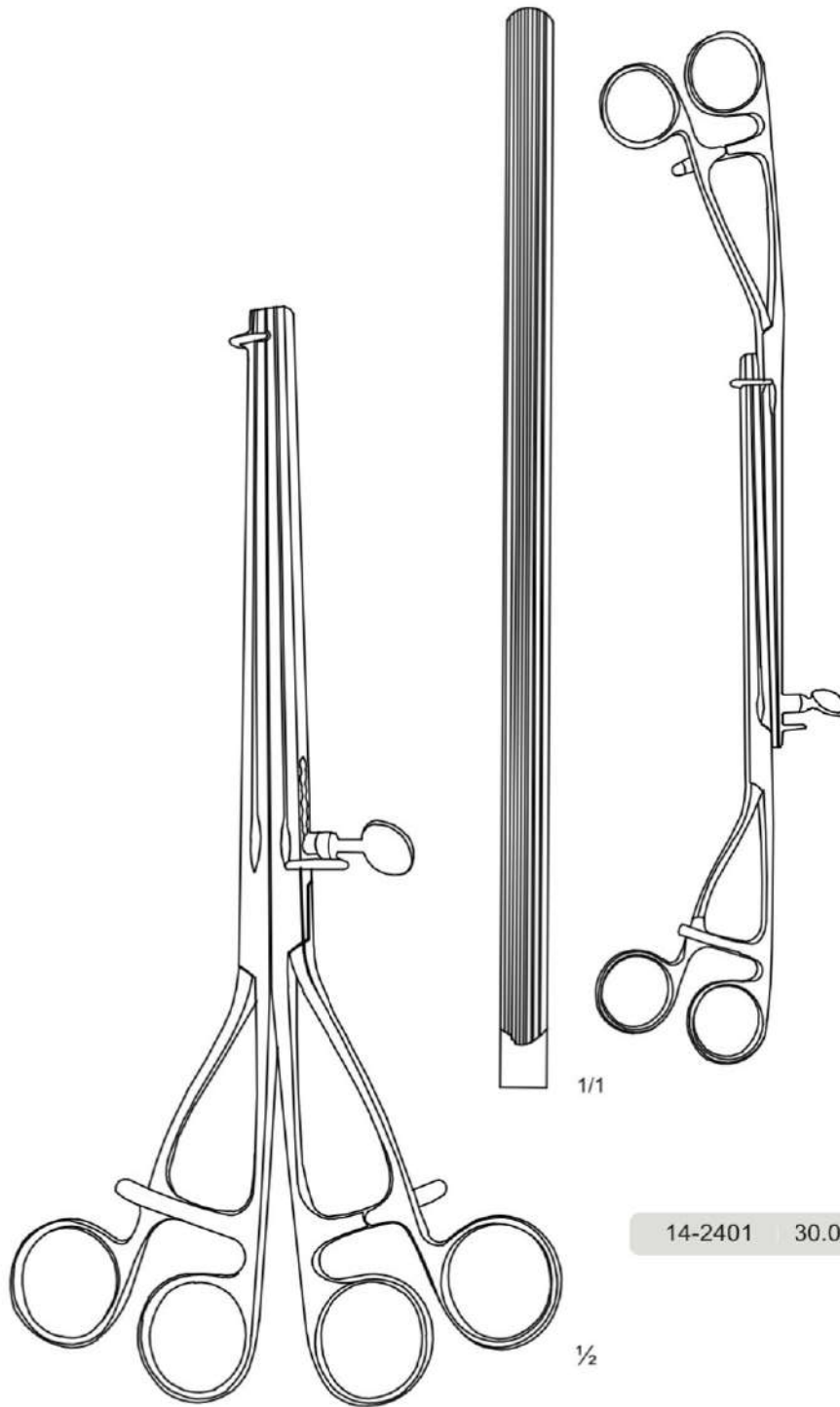

14-2401 30.0 cm Straight

**LANE**  
Stomach

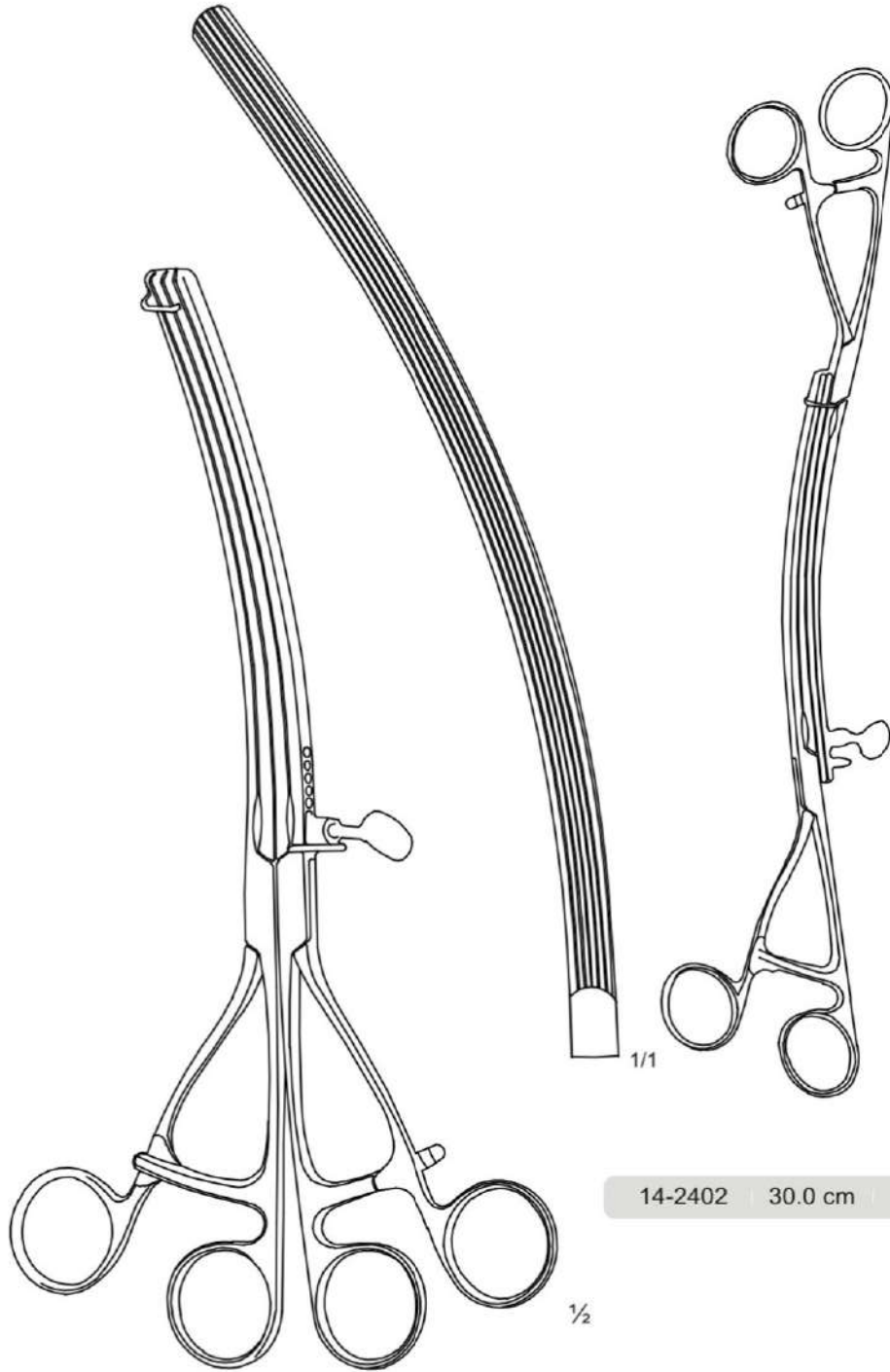

14-2402 30.0 cm Curved

**LANE**  
Stomach





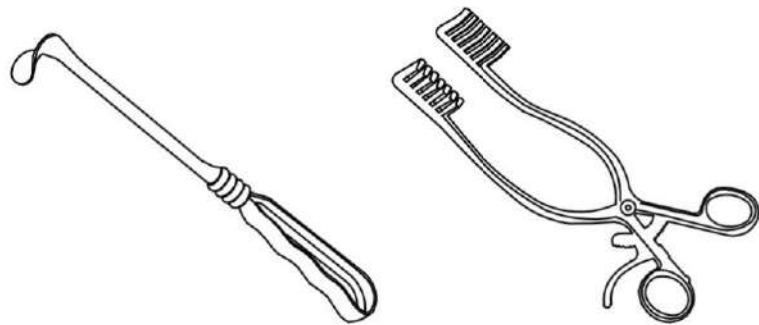

# Retractors

- *Hand Retractors*
- *Self Retraining Retractors*

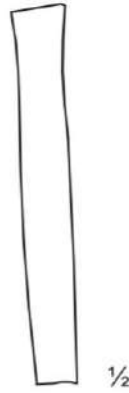

**UVULAR**

▶ 15-0100 | 11.0 cm



**FARABEUF**  
set

15-0200 | 13.0 cm

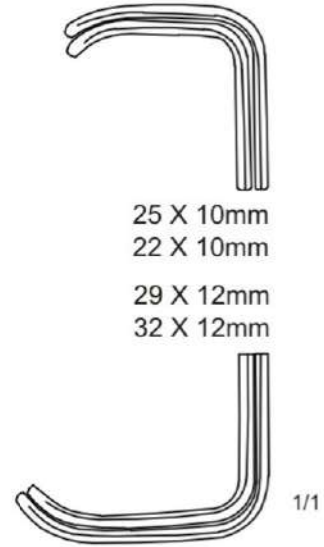

25 X 10mm  
22 X 10mm  
29 X 12mm  
32 X 12mm

1/1



**FARABEUF**  
set

15-0300 | 15.0 cm

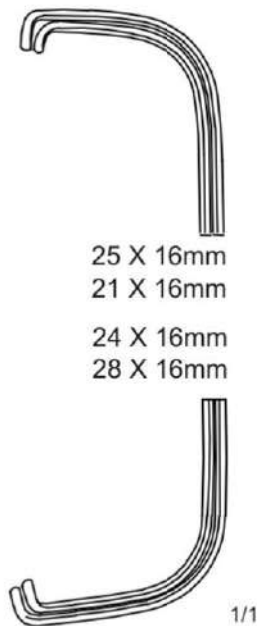

25 X 16mm  
21 X 16mm  
24 X 16mm  
28 X 16mm

1/1

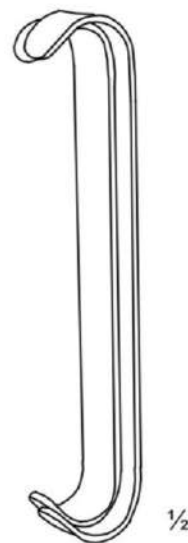

**PARKER**  
set

15-0400 | 13.5 cm

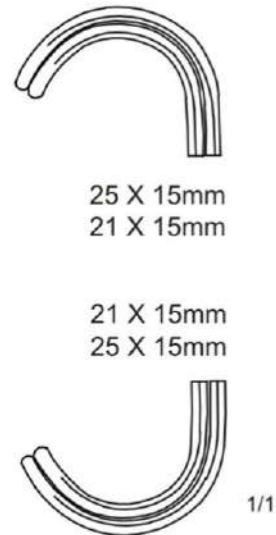

25 X 15mm  
21 X 15mm

21 X 15mm  
25 X 15mm

1/1

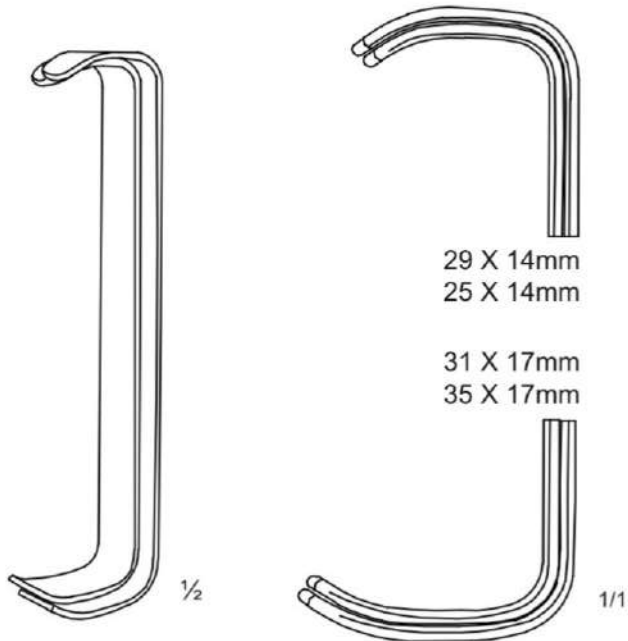

**COLLIN**  
set

15-0500 16.5 cm

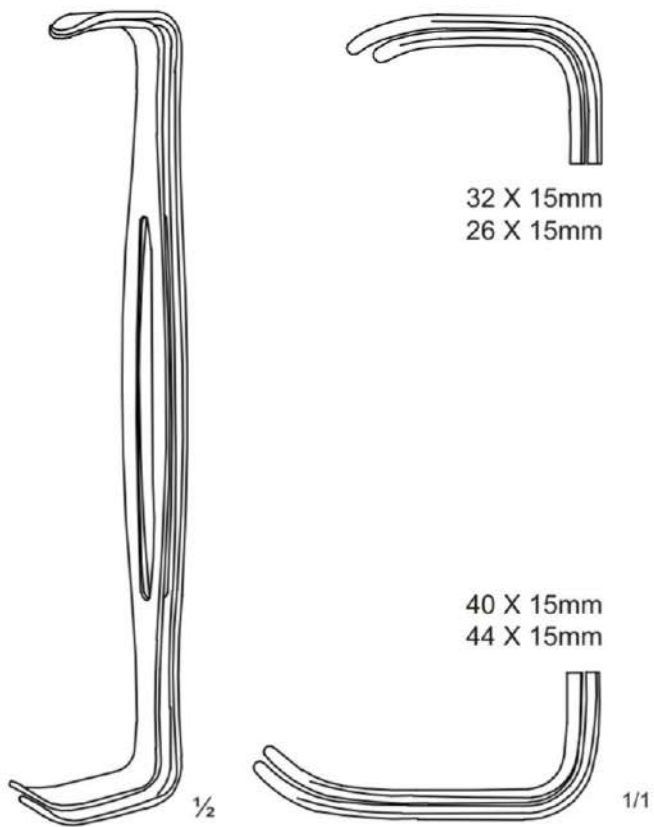

**US-ARMY**  
set

▶ 15-0600 22.0 cm

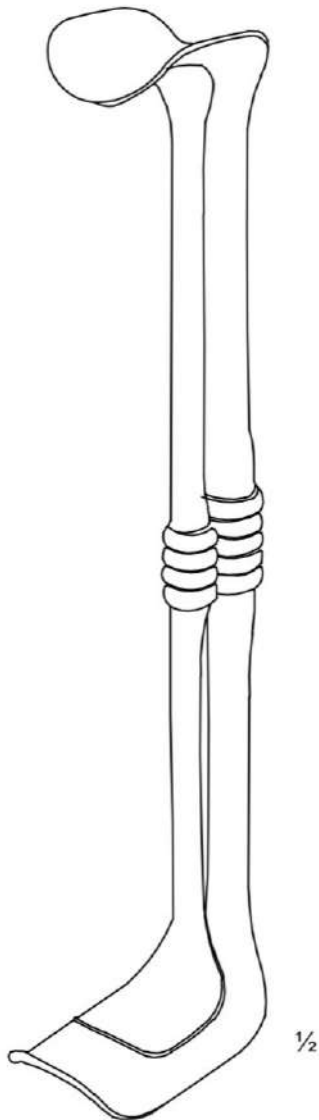

**RICHARDSON-EASTMAN**  
set

▶ 15-0700

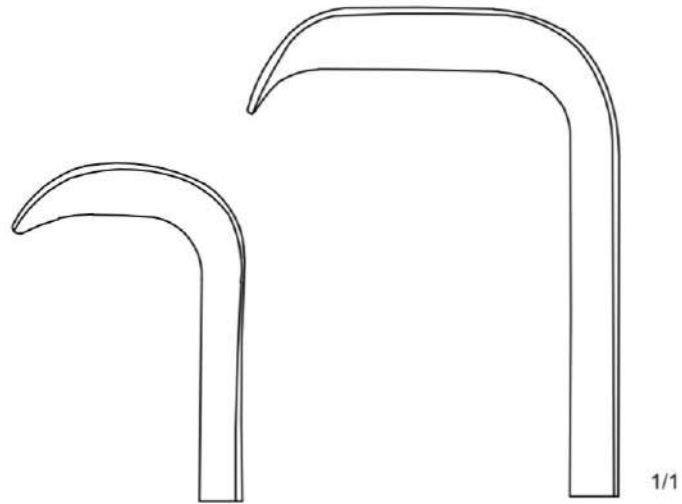

25 X 22mm

▶ 15-0701 25.0 cm

43 X 39mm

▶ 15-0702 27.0 cm

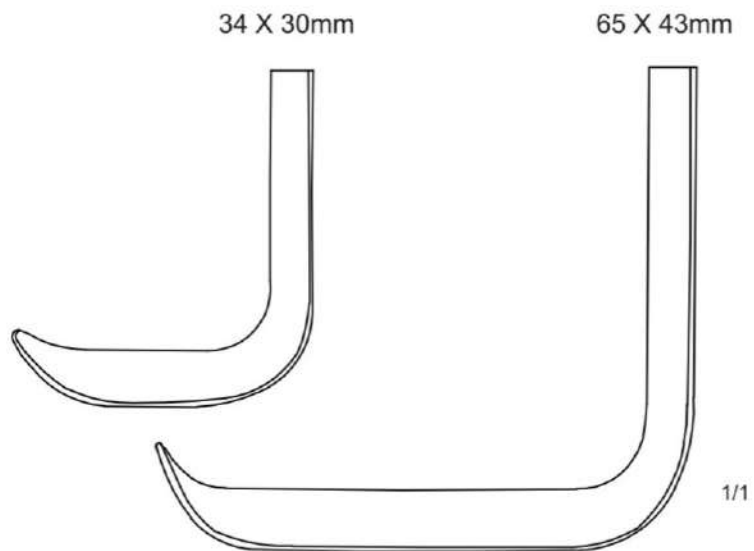

34 X 30mm

65 X 43mm

# Hand Retractors

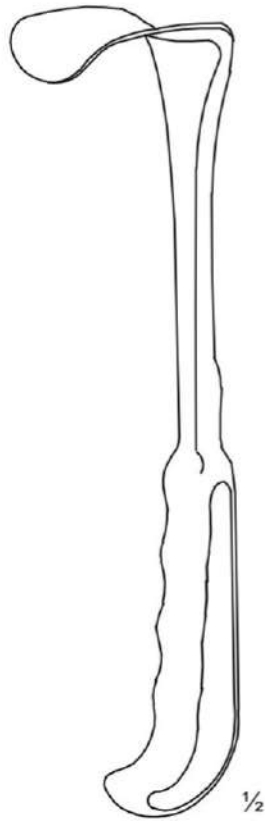

**KELLY**

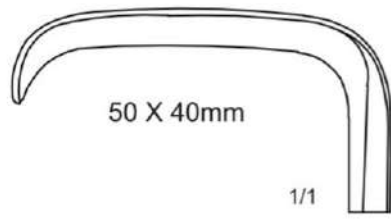

50 X 40mm

1/1

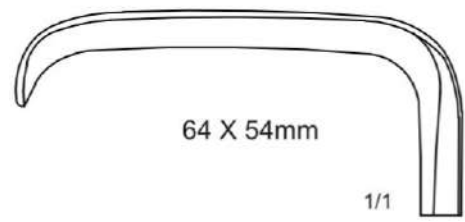

64 X 54mm

1/1

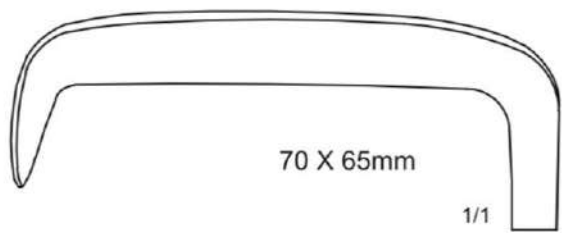

70 X 65mm

1/1

- ▶ 15-0801 50 x 40mm
- ▶ 15-0802 64 x 54mm
- ▶ 15-0803 70 x 65mm

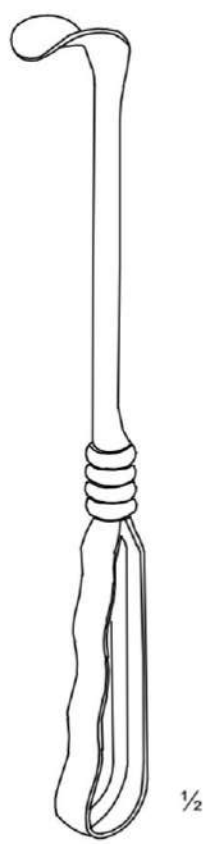

**RICHARDSON**

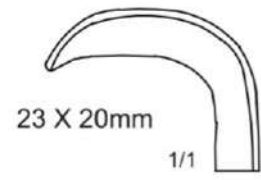

23 X 20mm

1/1

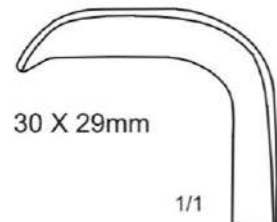

30 X 29mm

1/1

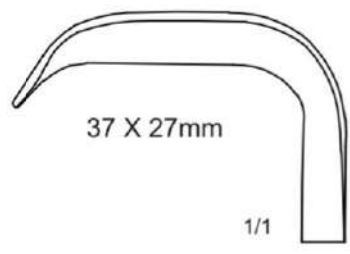

37 X 27mm

1/1

- 15-0901 23 x 20mm
- 15-0902 30 x 29mm
- 15-0903 37 x 27mm

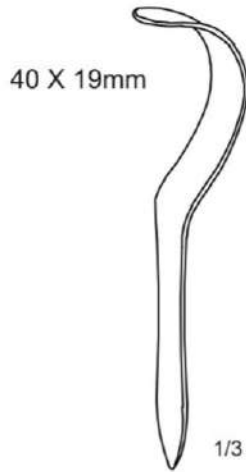

DEAVER

15-1001 | 18cm



DEAVER

▶ 15-1002 | 22cm

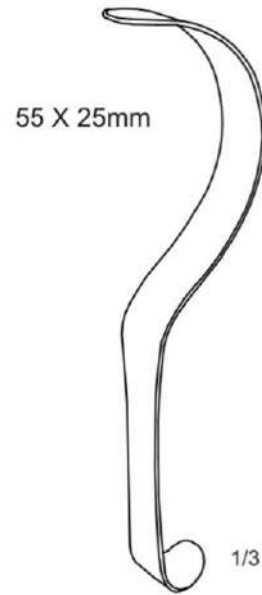

DEAVER

15-1003 | 23cm

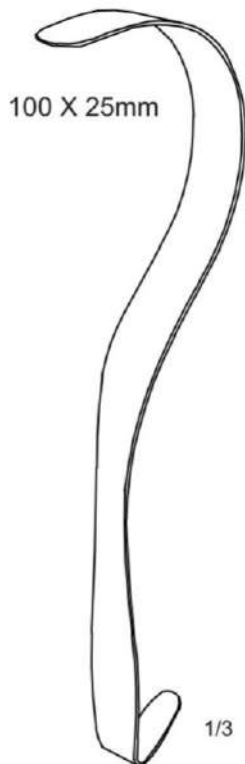

DEAVER

▶ 15-1004 | 30cm



DEAVER

15-1005 | 33cm

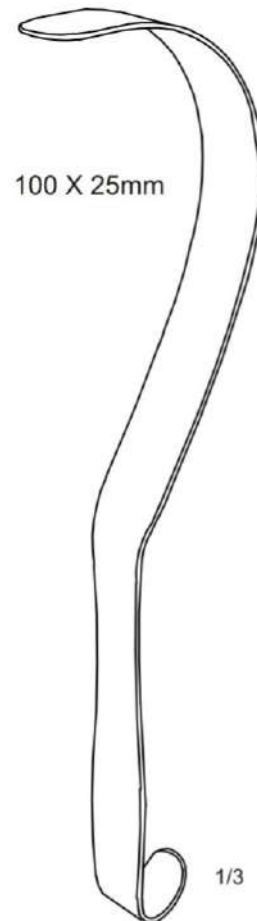

DEAVER

15-1006 | 36cm



# Hand Retractors



100 X 38mm



**DEAVER**

▶ 15-1007 | 30cm

100 X 50mm



**DEAVER**

▶ 15-1008 | 30cm

100 X 75mm

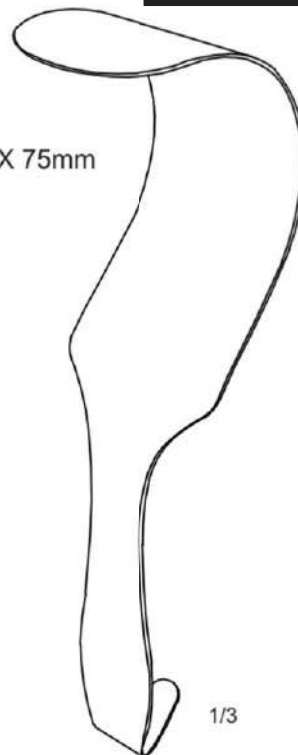

**DEAVER**

15-1009 | 30.5 cm

100 X 25mm



**DEAVER**  
with handle

15-1014 | 30cm

100 X 38mm



**DEAVER**  
with handle

15-1017 | 30cm

100 X 50mm



**DEAVER**  
with handle

15-1018 | 30cm

100 X 75mm

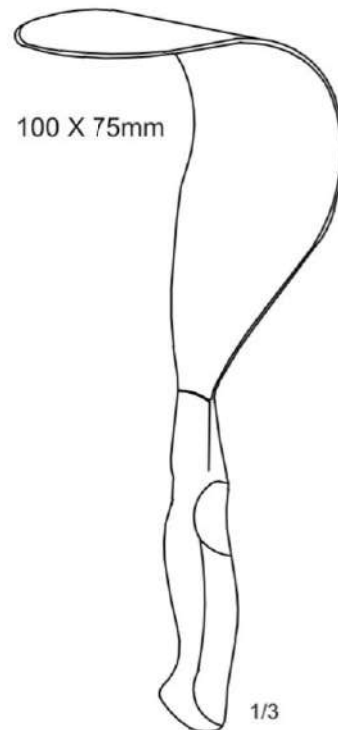

**DEAVER**  
with handle

15-1019 | 30cm



½

**RIBBON ABDOMINAL**  
Malleable

15-1101	200 x 12mm
15-1102	200 x 17mm
15-1103	250 x 25mm



½

**RIBBON ABDOMINAL**  
Malleable

▶ 15-1104	330 x 30mm
▶ 15-1105	330 x 40mm
▶ 15-1106	330 x 50mm

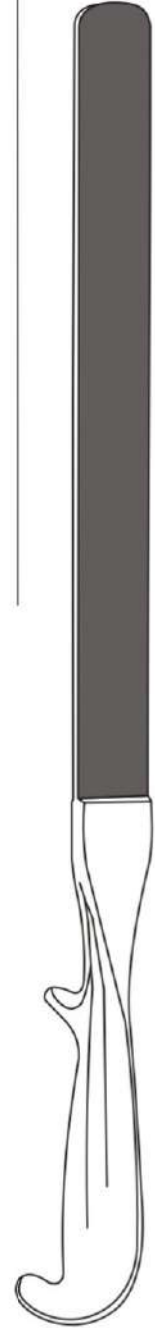
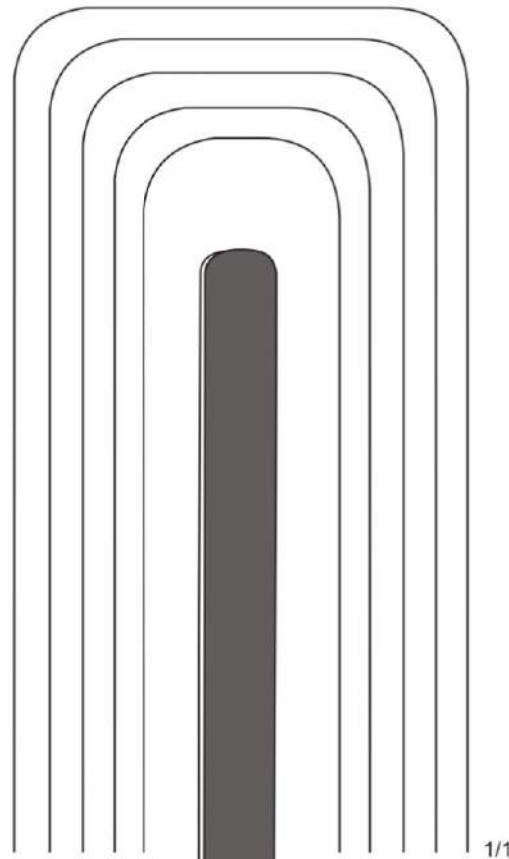

15-1201	30mm
15-1202	40mm
15-1203	50mm
15-1204	60mm
15-1205	70mm

**ABDOMINAL**  
Malleable

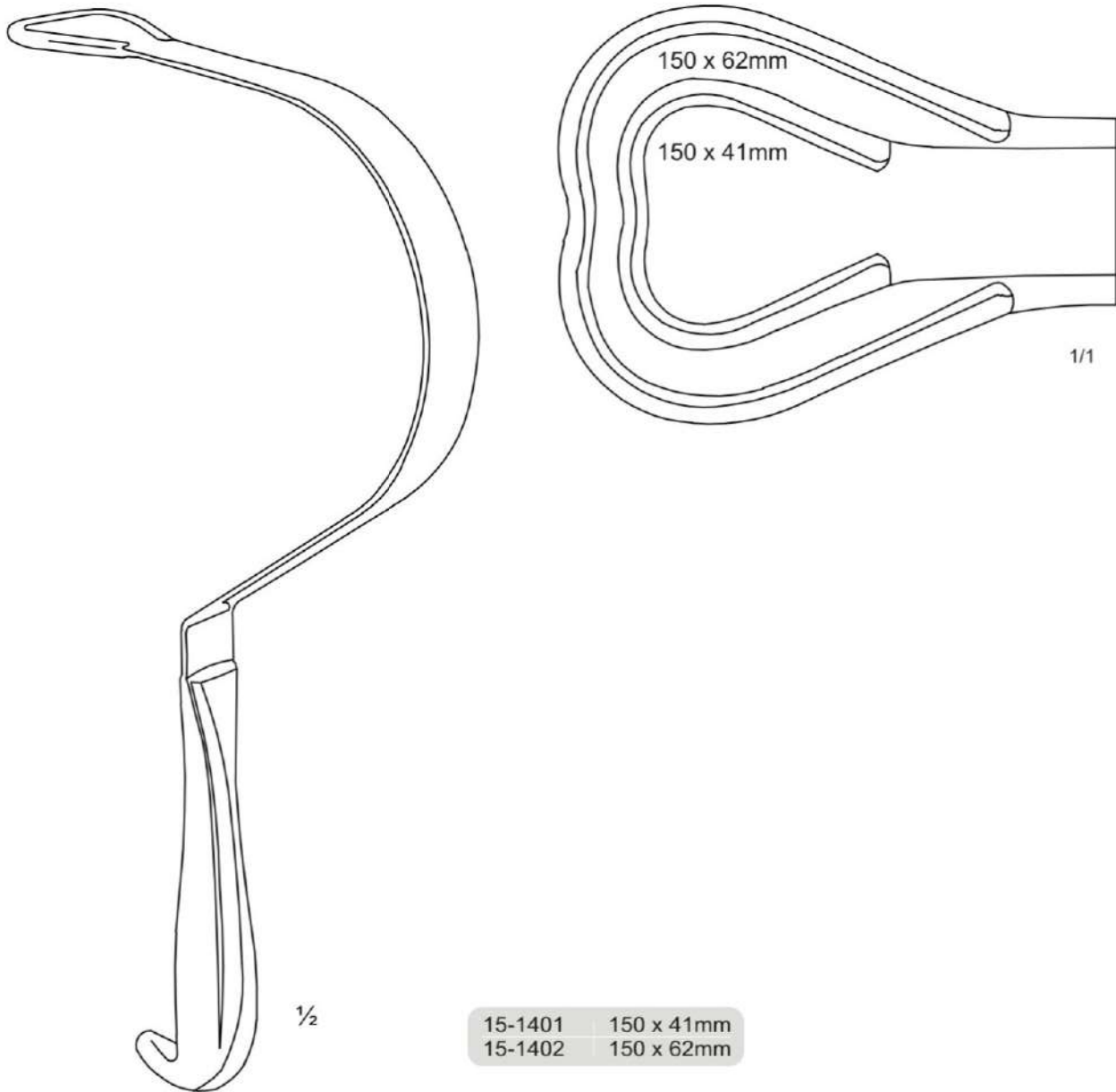

HARRINGTON

15-1401	150 x 41mm
15-1402	150 x 62mm

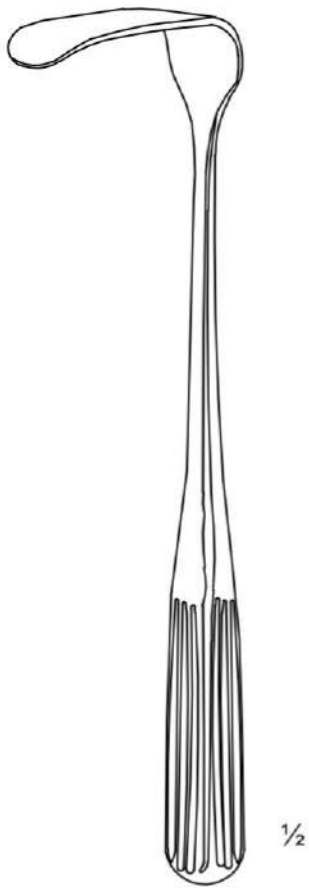
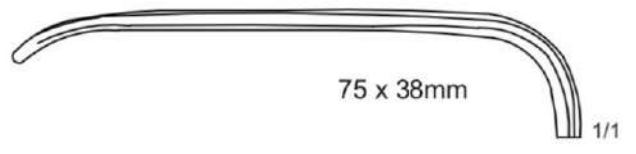
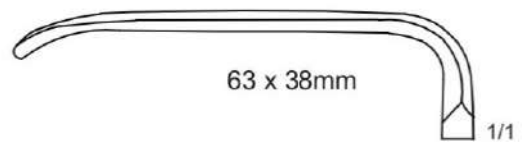
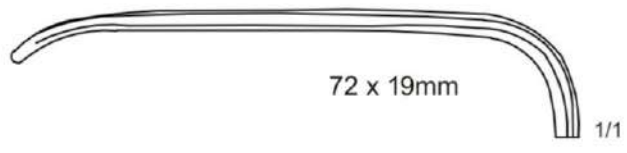
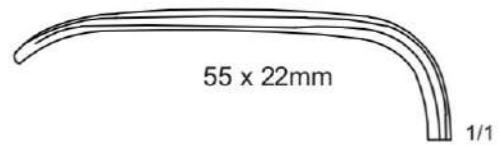
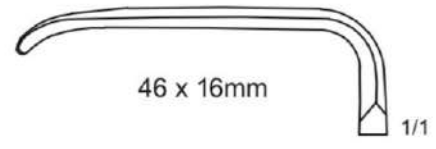

SAUERBRUCH

▶ 15-1501	46 x 16mm
▶ 15-1502	55 x 22mm
▶ 15-1503	72 x 19mm
▶ 15-1504	63 x 38mm
▶ 15-1505	75 x 38mm
▶ 15-1506	113 x 25mm

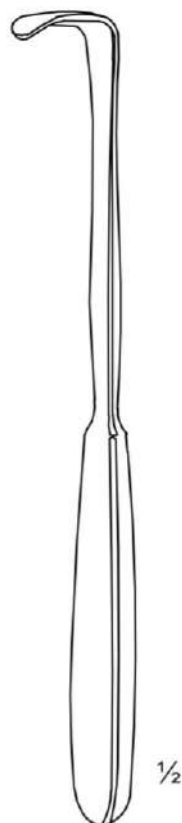
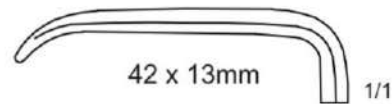
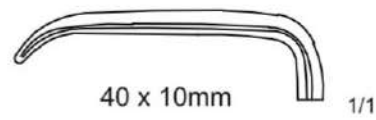
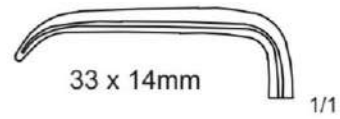
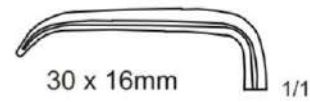
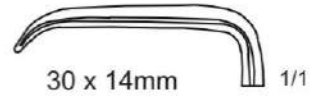

**LANGENBECK**

▶ 15-1601	28 x 10mm
▶ 15-1602	30 x 14mm
▶ 15-1603	30 x 16mm
▶ 15-1604	33 x 14mm
▶ 15-1605	40 x 10mm
▶ 15-1606	42 x 13mm



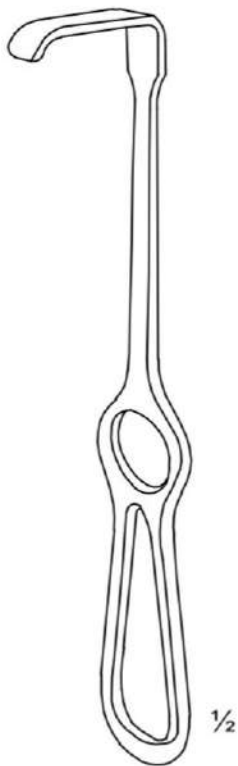
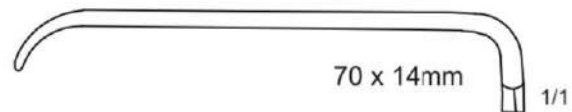
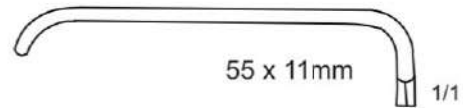
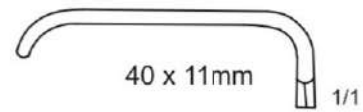
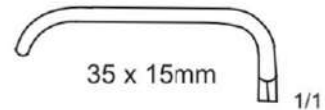
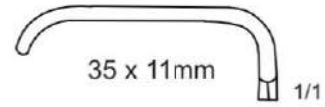
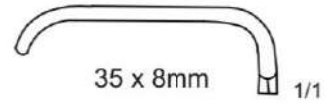
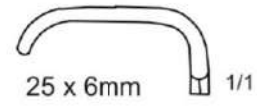

▶ 15-1701	25 x 6mm
▶ 15-1702	35 x 8mm
▶ 15-1703	35 x 11mm
▶ 15-1704	35 x 15mm
▶ 15-1705	40 x 11mm
▶ 15-1706	55 x 11mm
▶ 15-1707	70 x 14mm
▶ 15-1708	80 x 12mm
▶ 15-1709	80 x 16mm

KOCHER-LANGENBECK

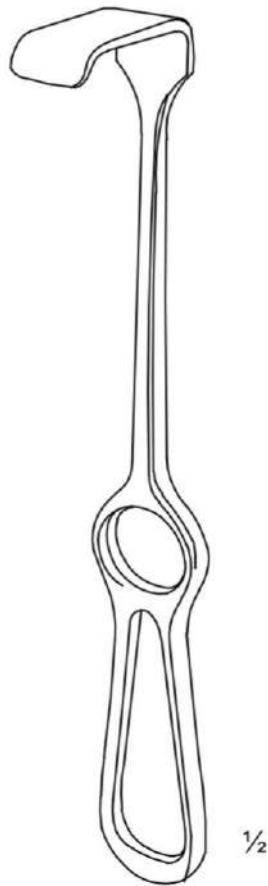

KOCHER

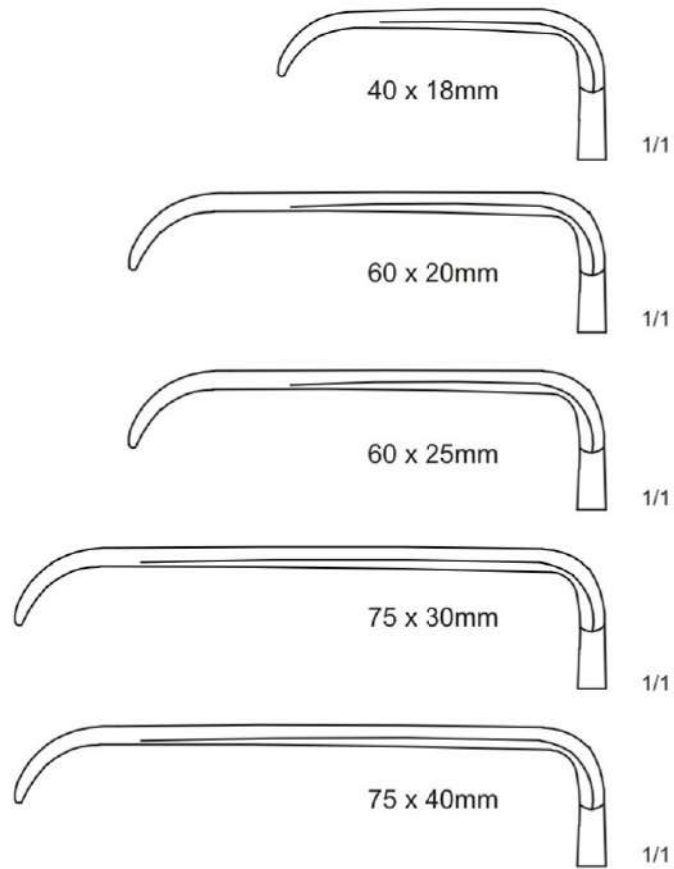

- ▶ 15-1801 40 x 18mm
- ▶ 15-1802 60 x 20mm
- ▶ 15-1803 60 x 25mm
- ▶ 15-1804 75 x 30mm
- ▶ 15-1805 75 x 40mm



1/2

- ▶ 15-1901 25 x 7mm
- ▶ 15-1902 31 x 10mm
- ▶ 15-1903 42 x 11mm
- ▶ 15-1904 55 x 12mm
- ▶ 15-1905 70 x 14mm
- ▶ 15-1906 80 x 16mm

**OBWEGESER**



1/2

- ▶ 15-1911 25 x 7mm
- ▶ 15-1912 31 x 10mm
- ▶ 15-1913 42 x 11mm
- ▶ 15-1914 55 x 12mm
- ▶ 15-1915 70 x 14mm
- ▶ 15-1916 80 x 16mm

**OBWEGESER**

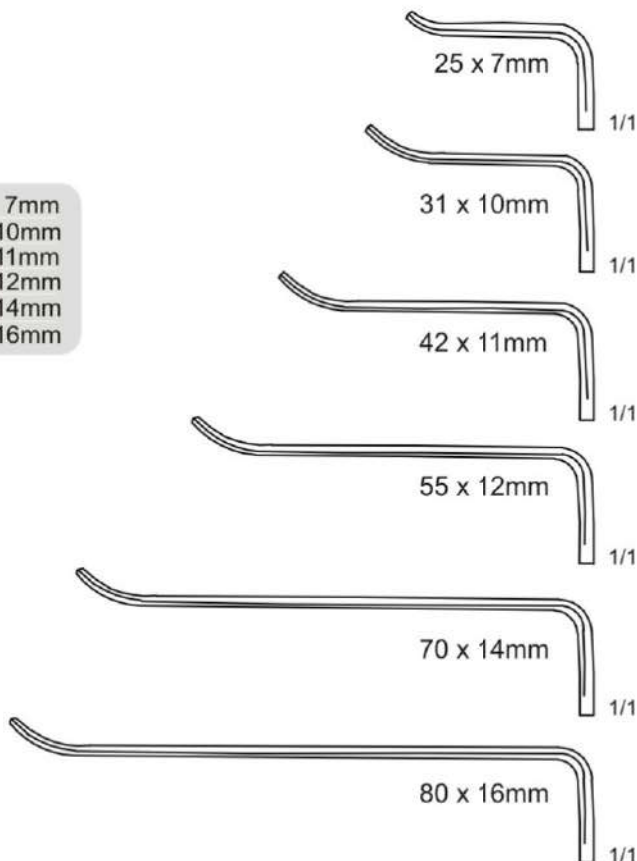
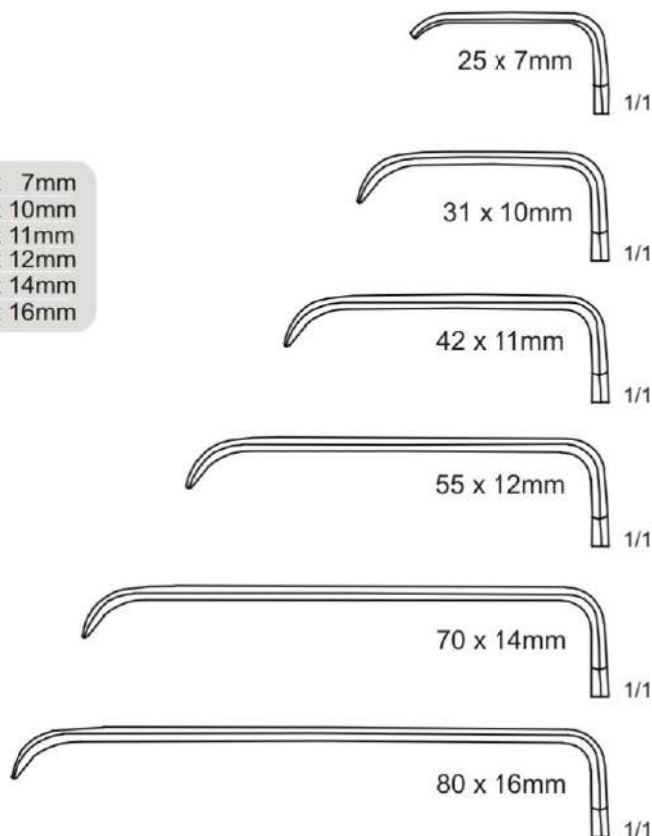

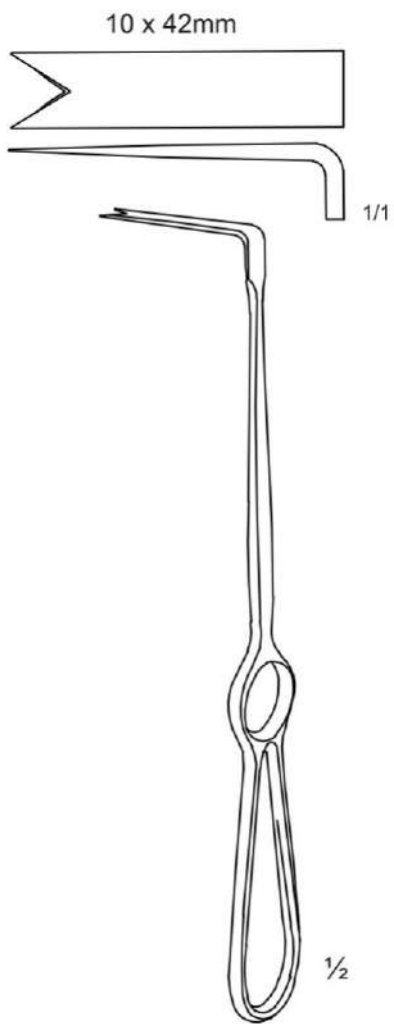

**OBWEGESER - RAMUS**

▶ 15-2001 | 22.0cm | 10 x 42mm

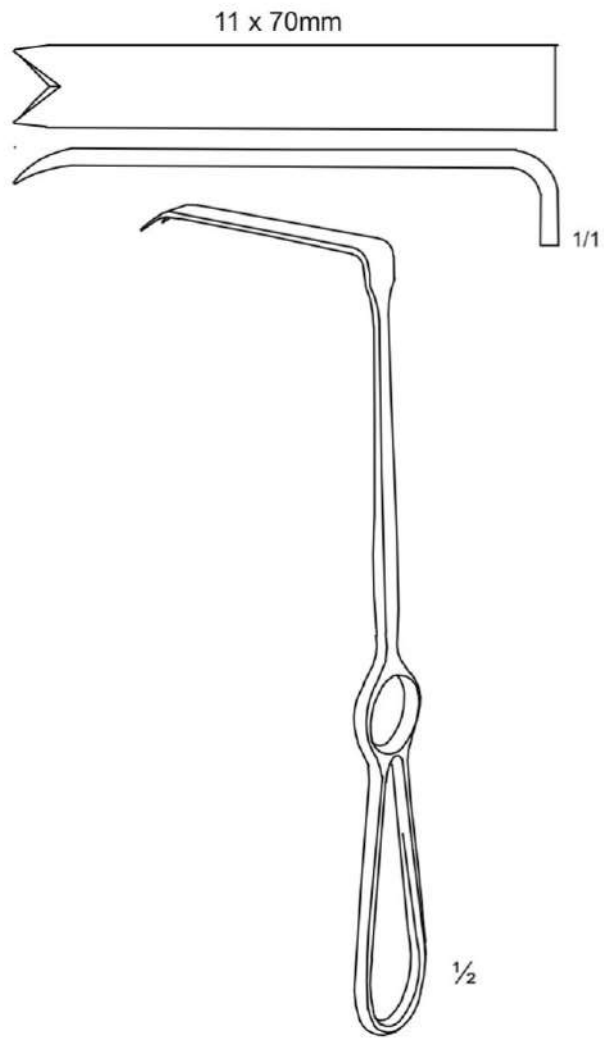

**OBWEGESER - RAMUS**

▶ 15-2002 | 22.0cm | 11 x 70mm  
 ▶ 15-2003 | 23.0cm | 13 x 70mm  
 ▶ 15-2004 | 20.5cm | 20 x 50mm

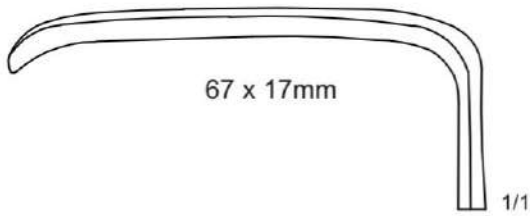

67 x 17mm

1/1

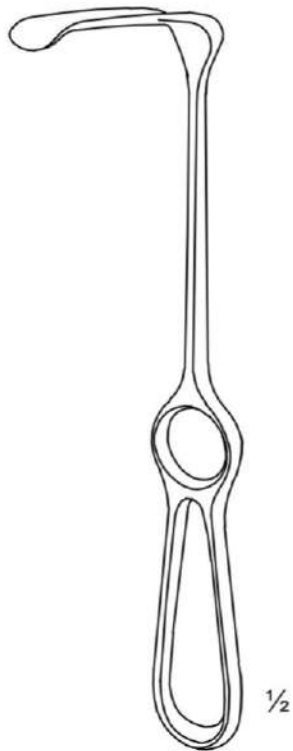

**CASPAR**

15-2200 22.5cm 67 x 17mm

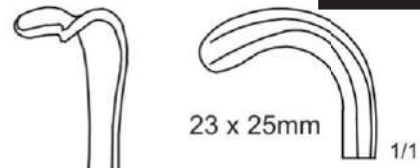

23 x 25mm

1/1

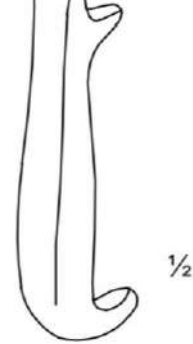

1/2

**YOUNG**

15-2300 23.0cm 23 x 25mm

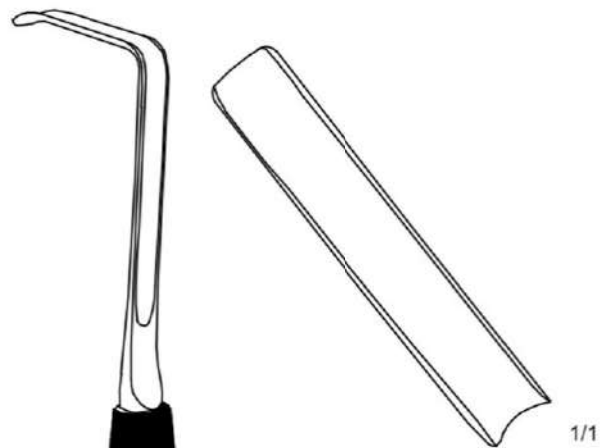

10 x 64mm

1/1



1/2

**OBWEGESER**

▶ 15-2400 24.0cm 10 x 64mm

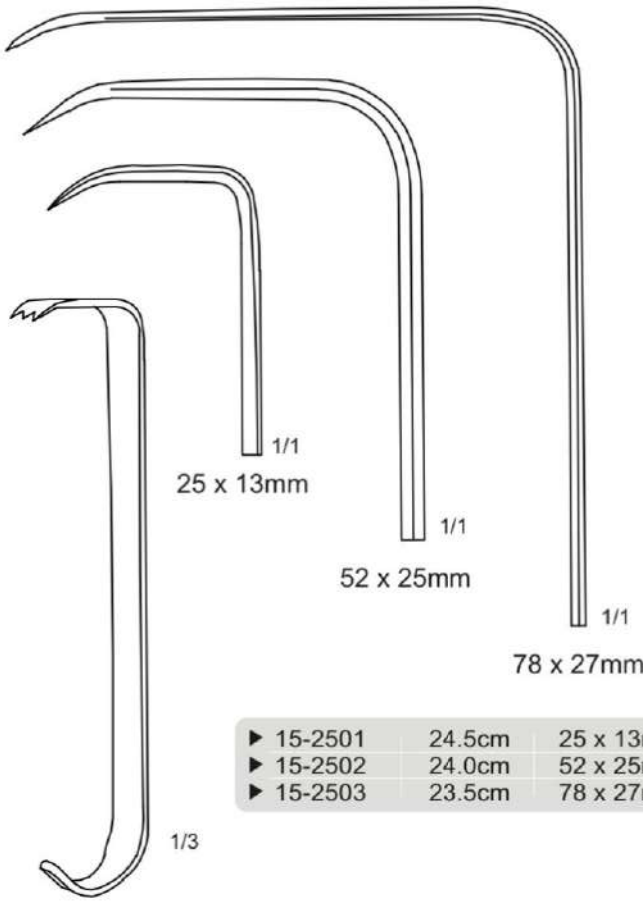

1/1  
25 x 13mm

1/1  
52 x 25mm

1/1  
78 x 27mm

1/3

**HIBBS**

▶ 15-2501	24.5cm	25 x 13mm
▶ 15-2502	24.0cm	52 x 25mm
▶ 15-2503	23.5cm	78 x 27mm

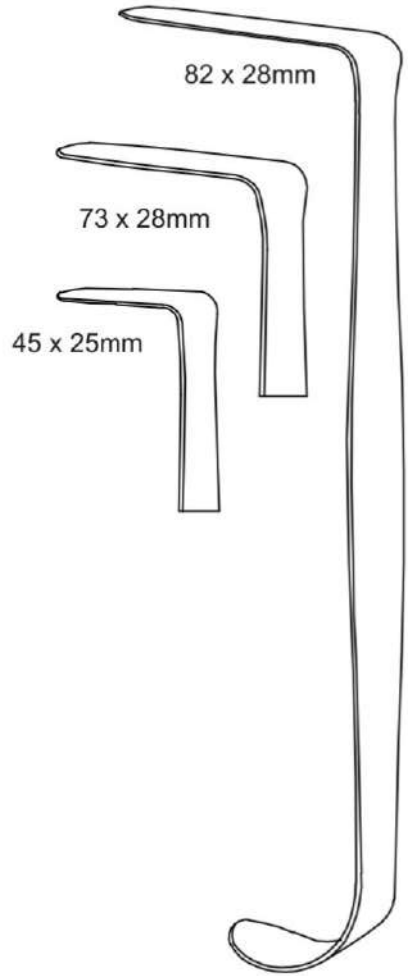

82 x 28mm

73 x 28mm

45 x 25mm

1/3

**HEANEY**

▶ 15-2601	45 x 25mm
▶ 15-2602	73 x 28mm
▶ 15-2603	82 x 28mm

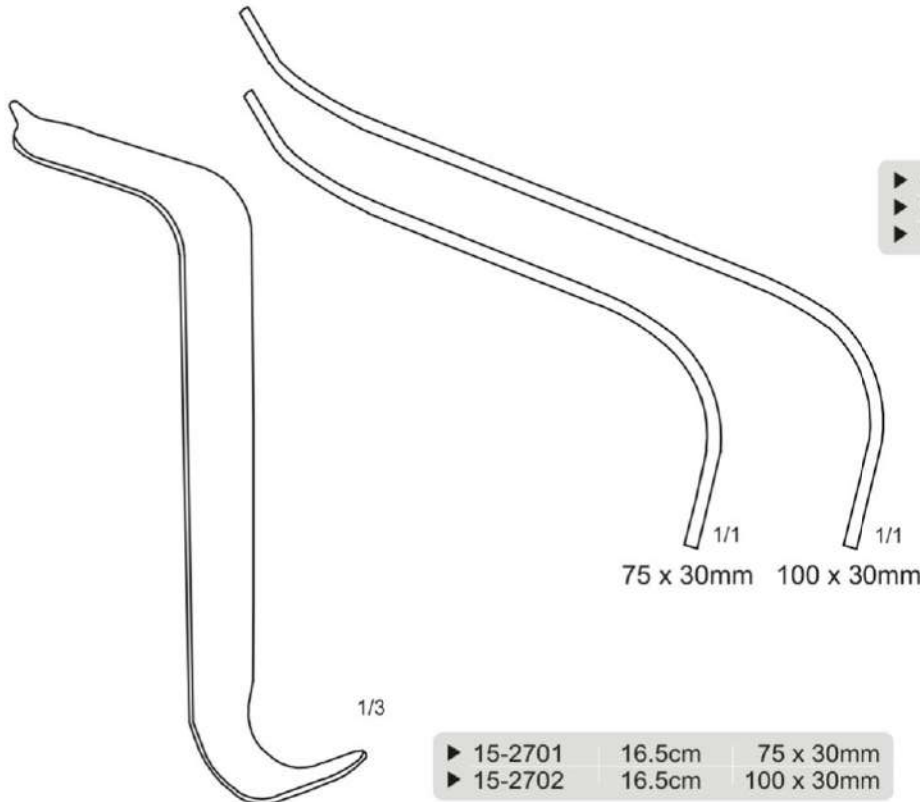

1/1  
75 x 30mm

1/1  
100 x 30mm

1/3

**TAYLOR**

▶ 15-2701	16.5cm	75 x 30mm
▶ 15-2702	16.5cm	100 x 30mm

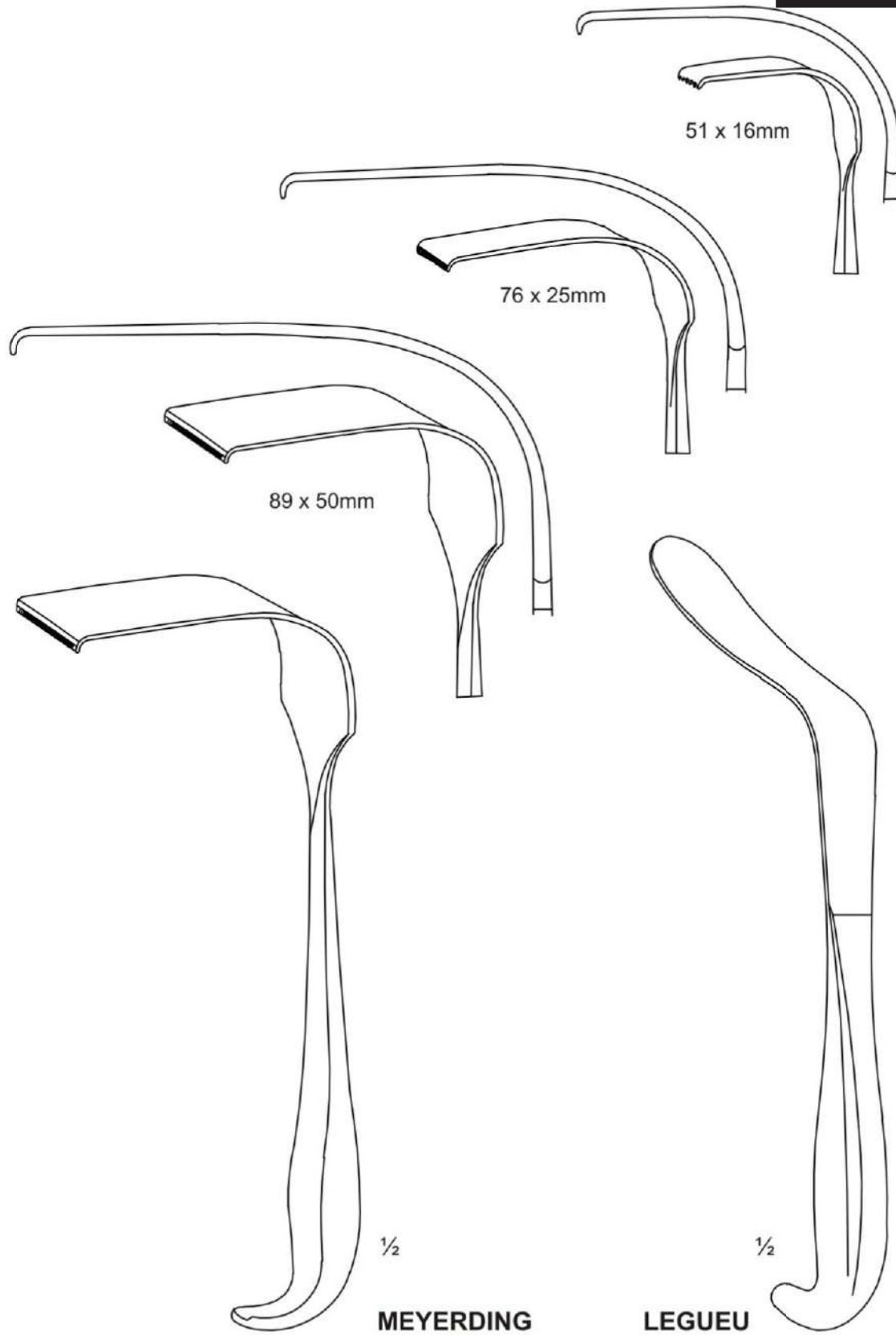

15-2901	21.0cm	51 x 16mm
15-2902	23.0cm	76 x 25mm
15-2903	25.5cm	89 x 50mm

15-2800	27.0cm	105 x 35mm
---------	--------	------------



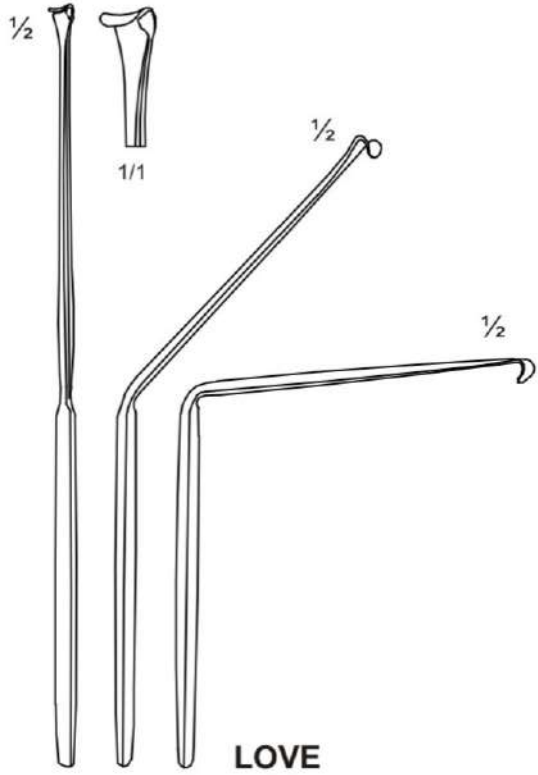

**LOVE**

- ▶ 15-3001 22.0cm Straight
- ▶ 15-3002 22.0cm 45° Angled
- ▶ 15-3003 22.0cm 90° Angled

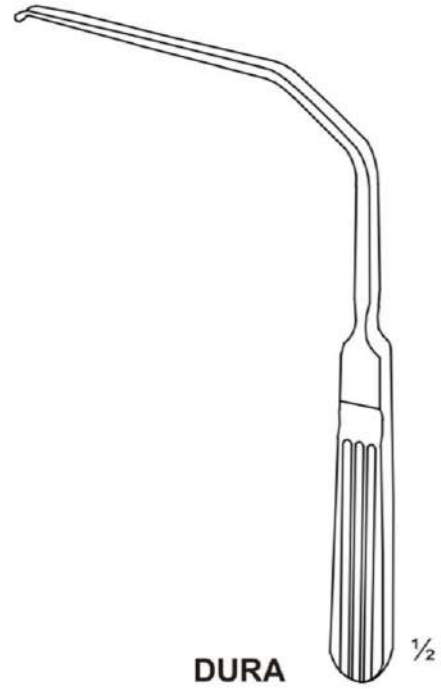

**DURA**

- ▶ 15-3101 18.0cm 3 x 10mm
- ▶ 15-3102 18.0cm 4 x 10mm
- ▶ 15-3103 18.0cm 5 x 10mm
- ▶ 15-3104 18.0cm 7 x 10mm

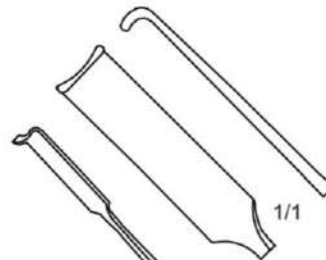
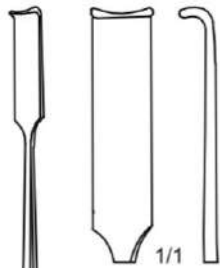

**SCOVILLE**

- ▶ 15-3201 23.0cm Straight



**SCOVILLE**

- ▶ 15-3211 20.0cm Curved

# Hand Retractors



**ROOT**

▶ 15-3300 23.0cm 6mm

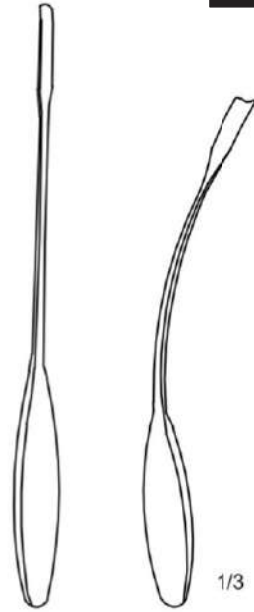

**LEE'S**

▶ 15-3402	23.0cm	8mm	Straight
▶ 15-3411	23.0cm	6mm	Curved
▶ 15-3412	23.0cm	8mm	Curved

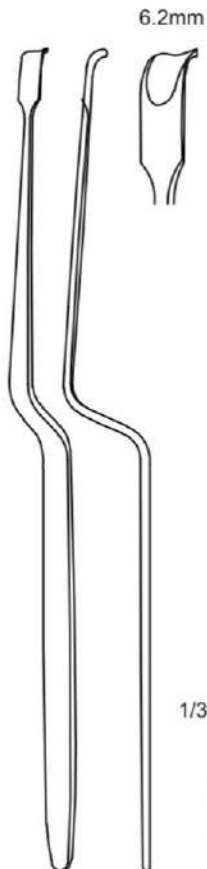

**D'ERRICO**

▶ 15-3500 23.0cm Bayonet Style

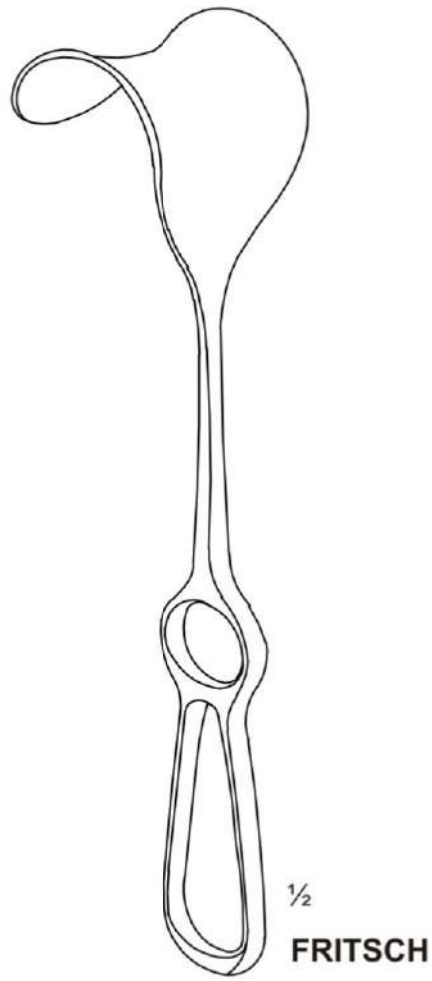
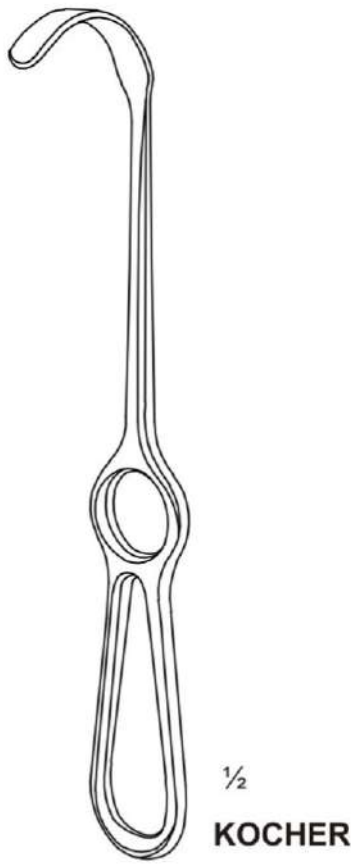
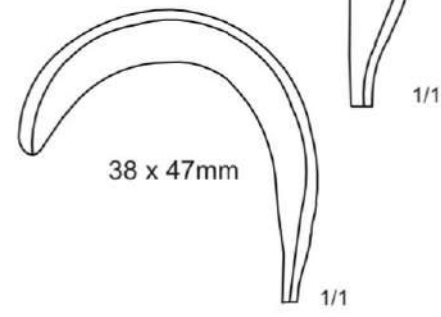
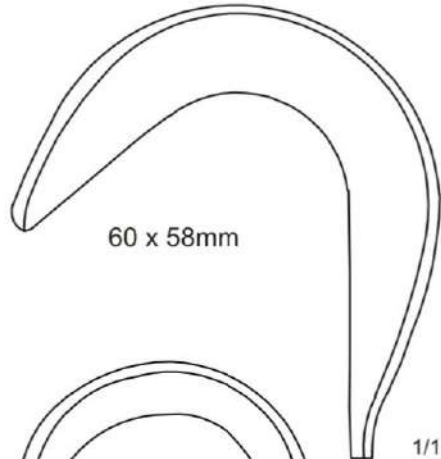
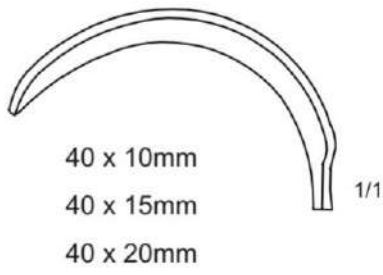
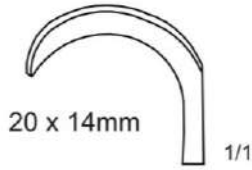

15-3601	20.5cm	20 x 12mm
15-3602	20.5cm	20 x 14mm
15-3603	22.0cm	40 x 10mm
15-3604	22.0cm	40 x 15mm
15-3605	22.0cm	40 x 20mm

▶ 15-3701	23.5cm	38 x 47mm
▶ 15-3702	26.0cm	60 x 58mm

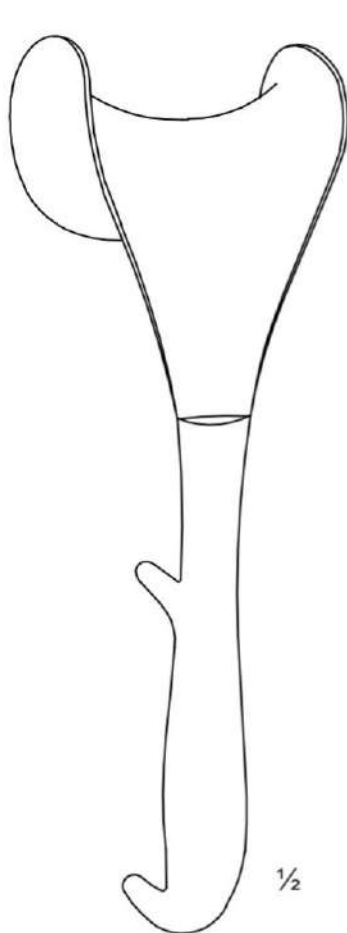
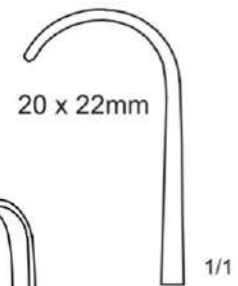
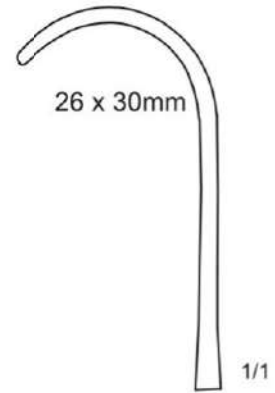
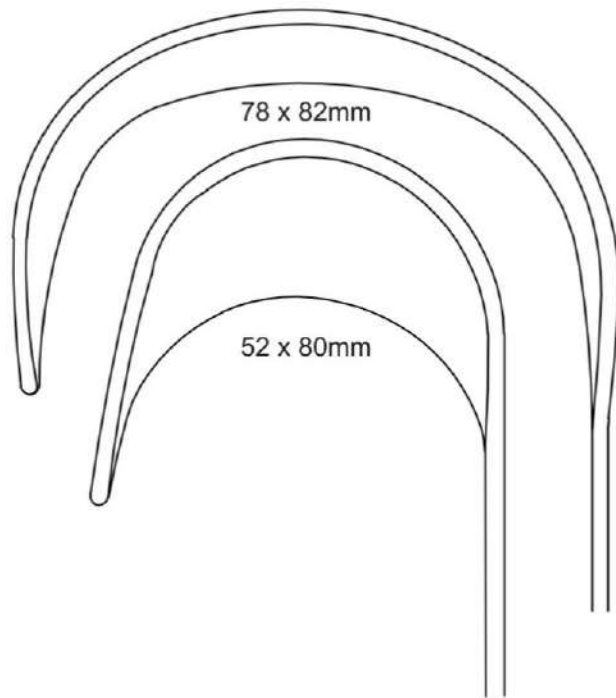

**DOYEN**

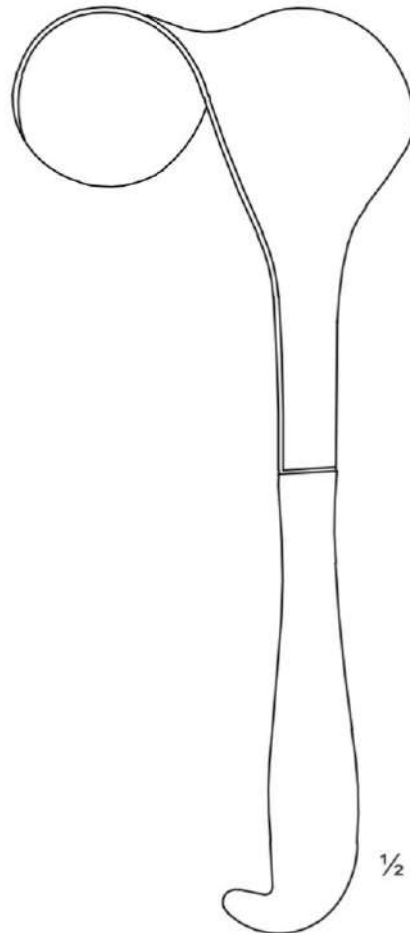

**DOYEN**

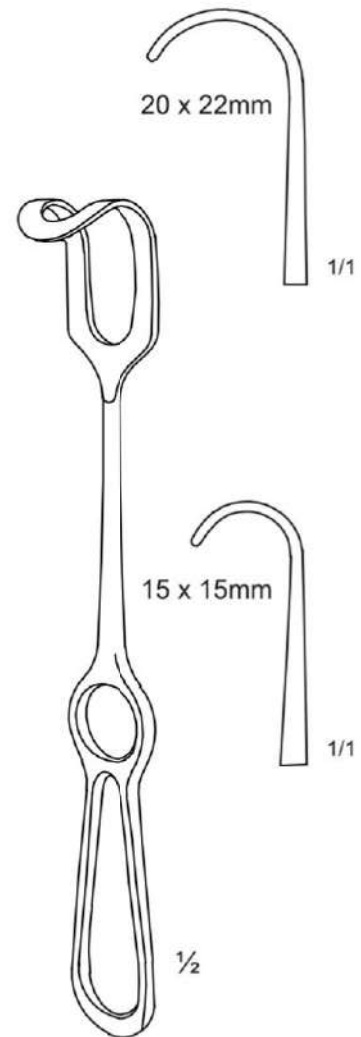

**MIDDELDORPF**

▶ 15-3801	24.0cm	52 x 80mm
▶ 15-3802	26.0cm	78 x 82mm

15-3901	20.0cm	15 x 15mm
15-3902	21.0cm	20 x 22mm
15-3903	23.0cm	26 x 30mm

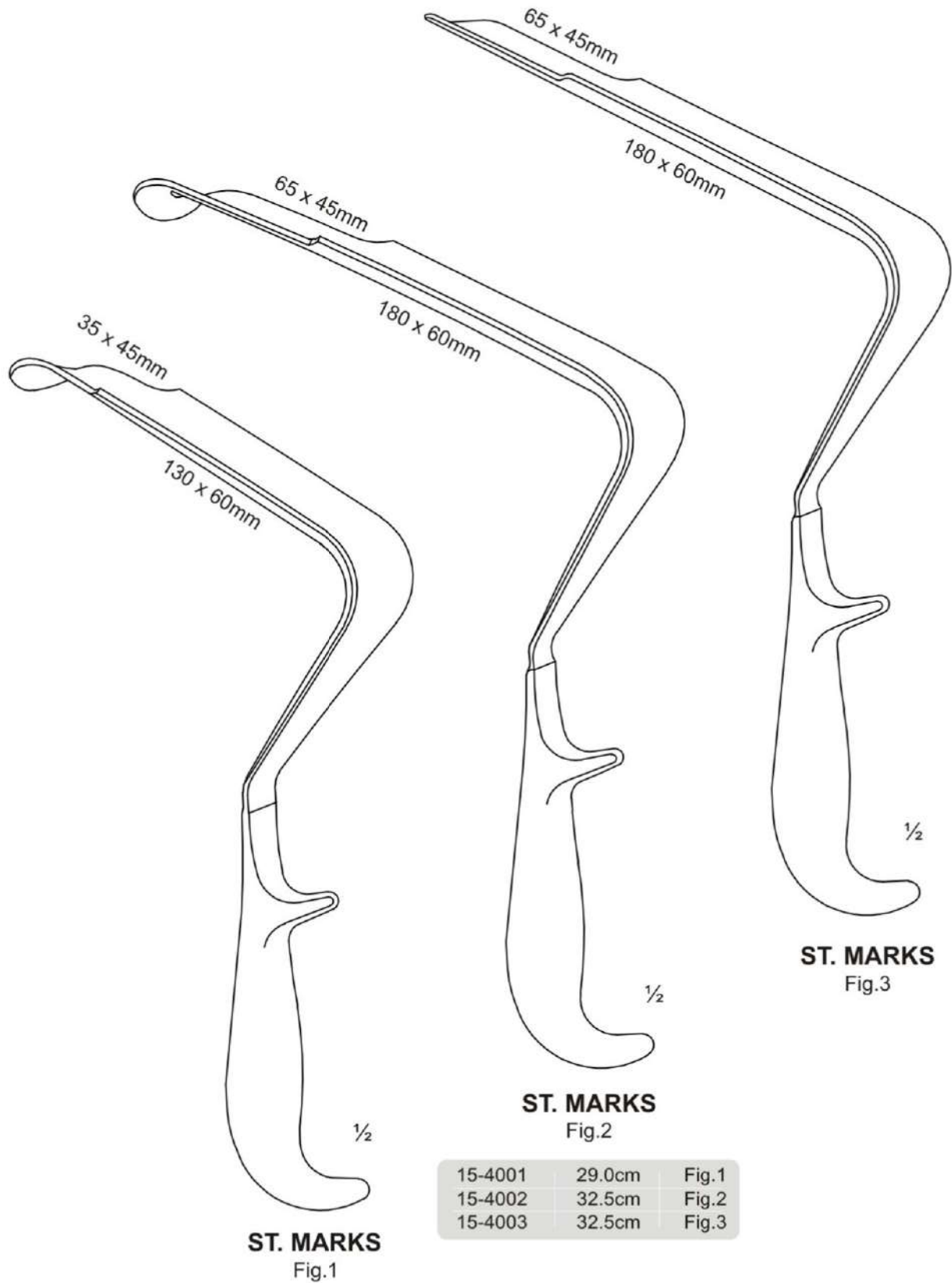

15-4001	29.0cm	Fig.1
15-4002	32.5cm	Fig.2
15-4003	32.5cm	Fig.3

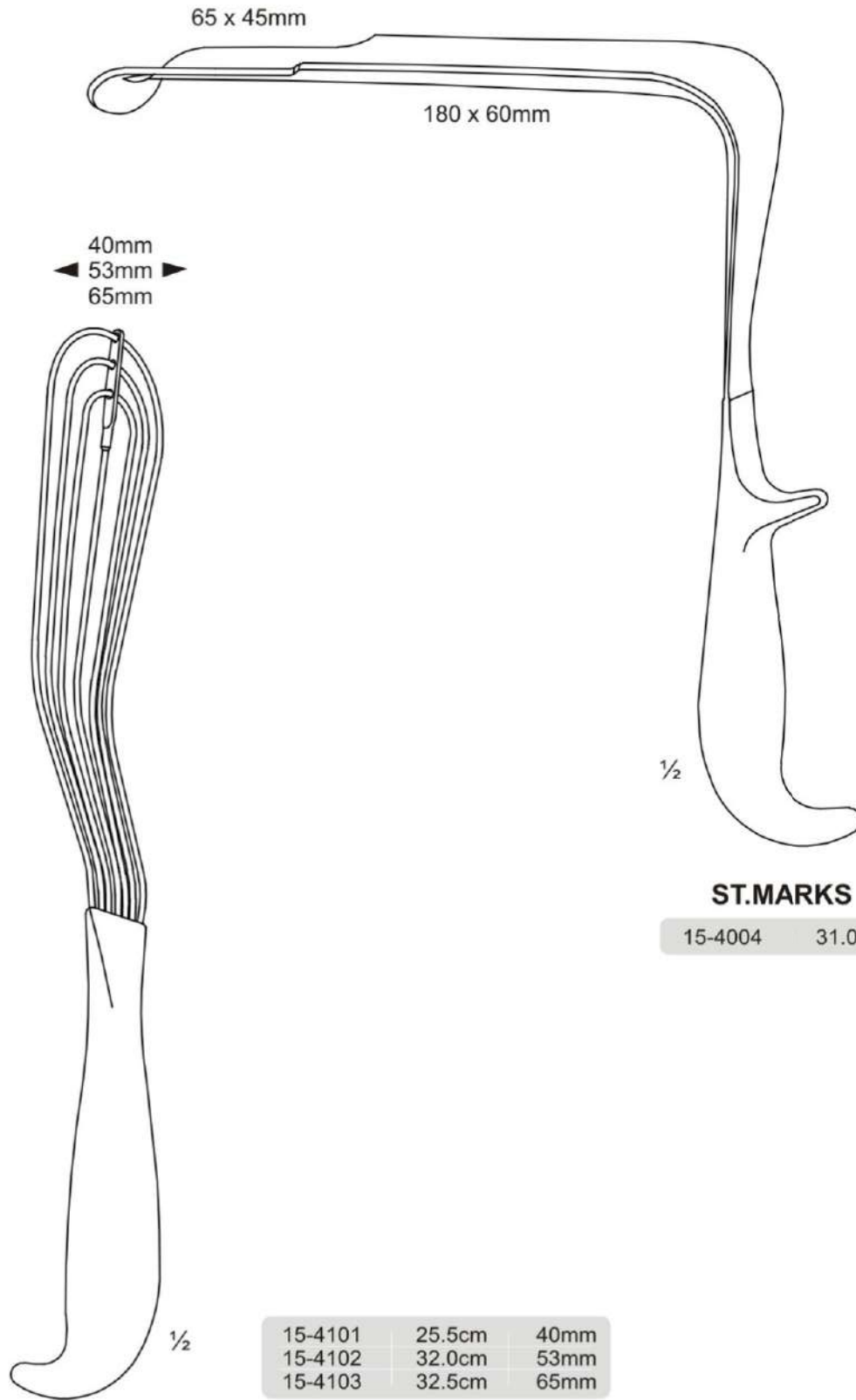

**ST.MARKS**

15-4004 31.0cm

**ALLISON**

15-4101	25.5cm	40mm
15-4102	32.0cm	53mm
15-4103	32.5cm	65mm

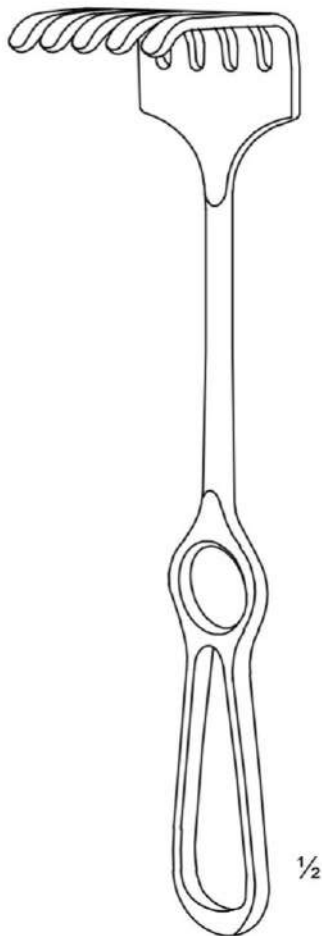
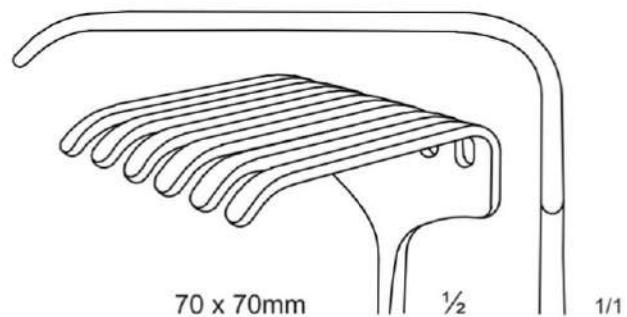
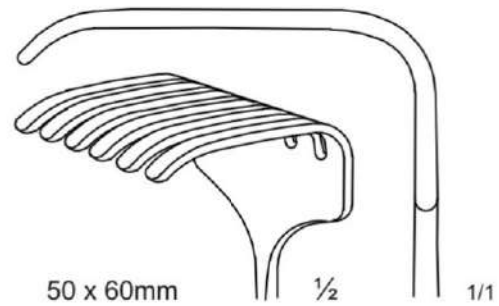
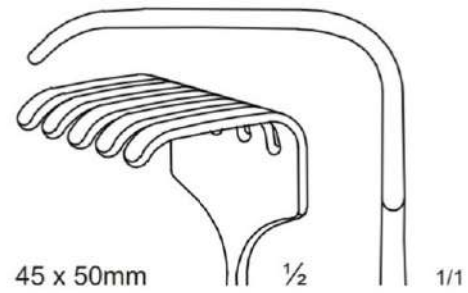
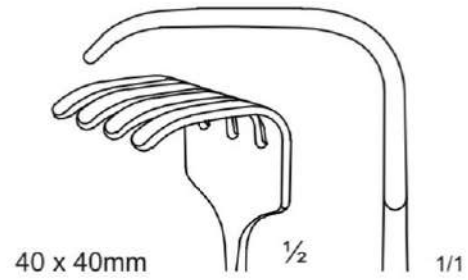

**ISRAEL**

- ▶ 15-4201 40 x 40mm
- ▶ 15-4202 45 x 50mm
- ▶ 15-4203 50 x 60mm
- ▶ 15-4204 70 x 70mm



# Hand Retractors

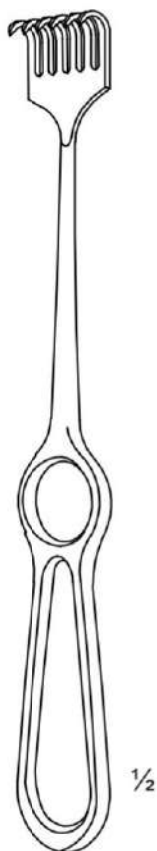
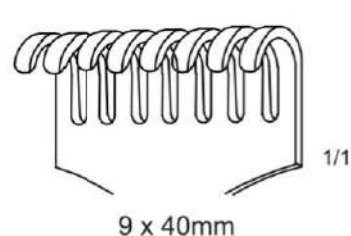
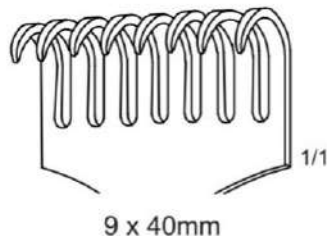
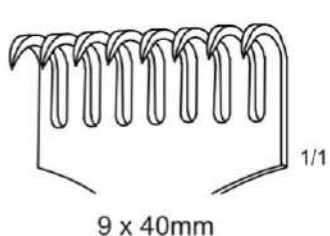
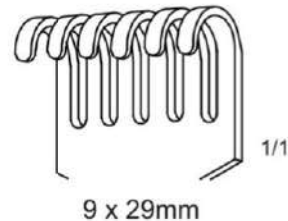
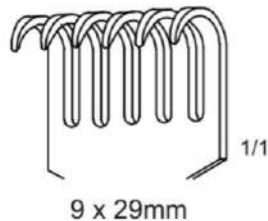
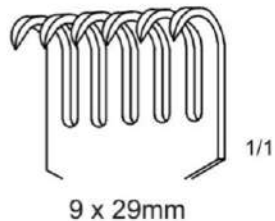
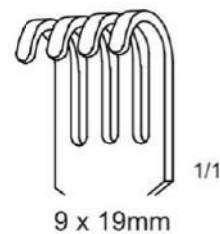
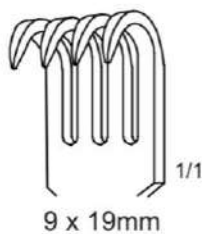
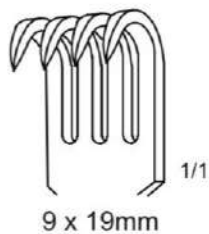
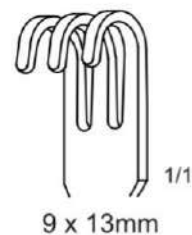
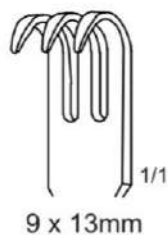
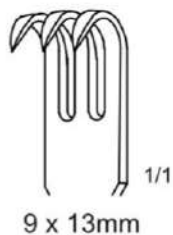
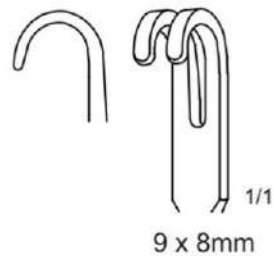
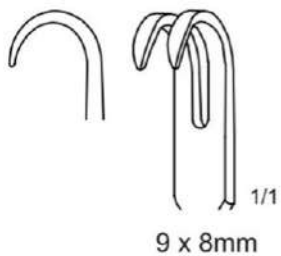
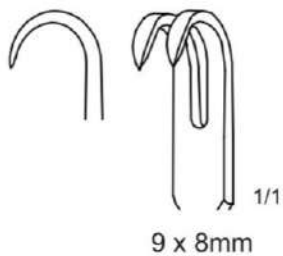

## VOLKMANN

▶ 15-4302	2prongs	Sharp
▶ 15-4303	3prongs	Sharp
▶ 15-4304	4prongs	Sharp
▶ 15-4305	6prongs	Sharp
▶ 15-4307	7prongs	Sharp

▶ 15-4402	2prongs	Semi-Sharp
▶ 15-4403	3prongs	Semi-Sharp
▶ 15-4404	4prongs	Semi-Sharp
▶ 15-4405	6prongs	Semi-Sharp
▶ 15-4407	7prongs	Semi-Sharp

▶ 15-4502	2prongs	Blunt
▶ 15-4503	3prongs	Blunt
▶ 15-4504	4prongs	Blunt
▶ 15-4505	6prongs	Blunt
▶ 15-4507	7prongs	Blunt

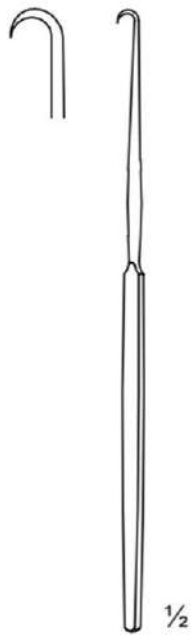

**TRACHEA**  
Sharp

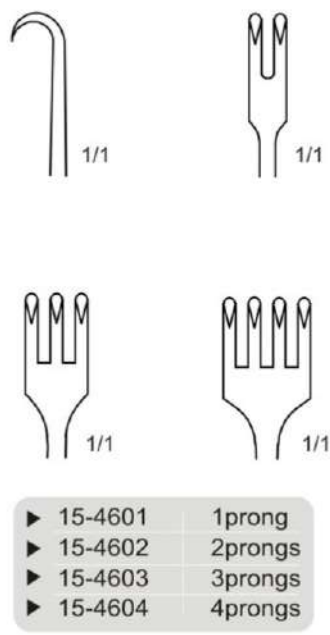

- ▶ 15-4601 1prong
- ▶ 15-4602 2prongs
- ▶ 15-4603 3prongs
- ▶ 15-4604 4prongs

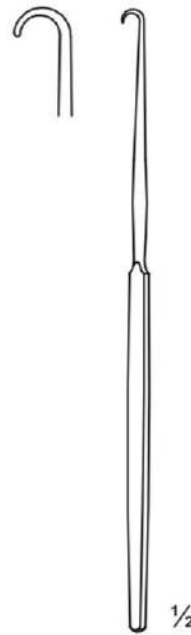

**TRACHEA**  
Blunt

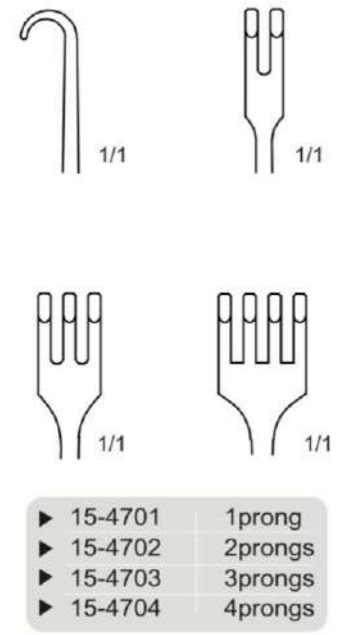

- ▶ 15-4701 1prong
- ▶ 15-4702 2prongs
- ▶ 15-4703 3prongs
- ▶ 15-4704 4prongs



**TRACHEA**  
Sharp, flexible

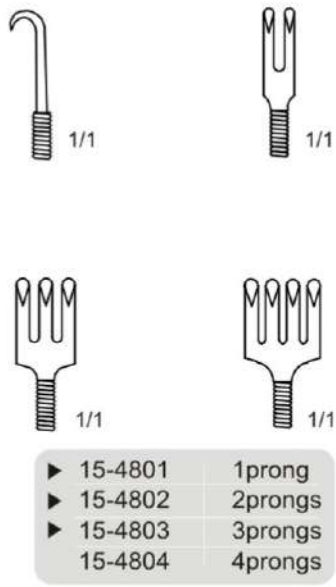

- ▶ 15-4801 1prong
- ▶ 15-4802 2prongs
- ▶ 15-4803 3prongs
- ▶ 15-4804 4prongs

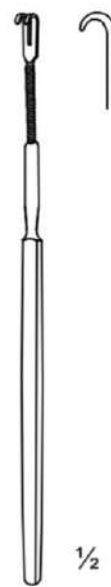

**TRACHEA**  
Blunt, flexible

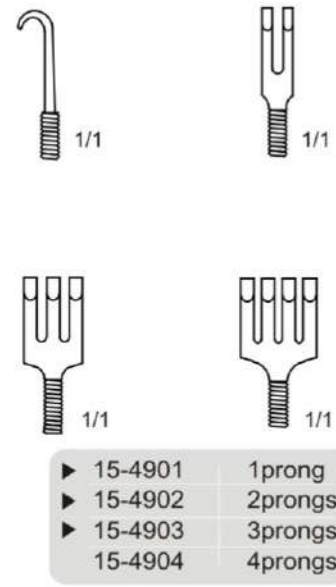

- ▶ 15-4901 1prong
- ▶ 15-4902 2prongs
- ▶ 15-4903 3prongs
- ▶ 15-4904 4prongs

# Hand Retractors

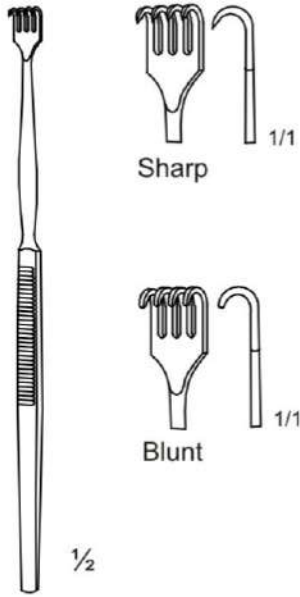

## TRACHEA

15-5004	16.0cm	4prongs sharp
15-5104	16.0cm	4prongs blunt

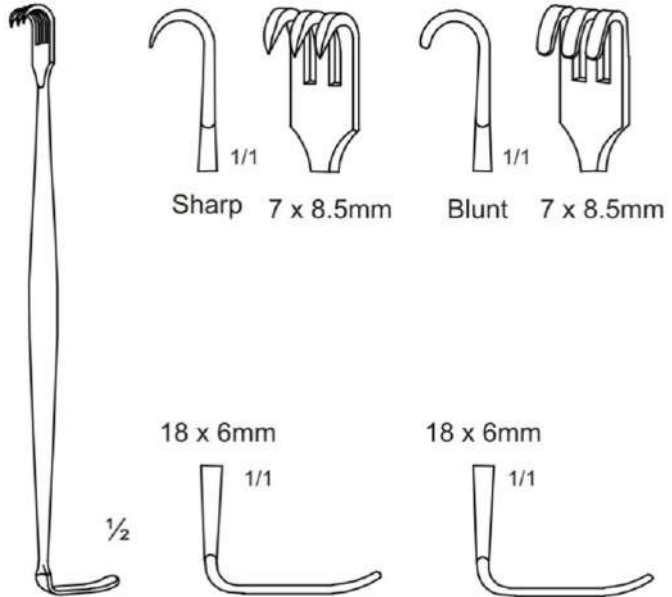

## SENN-MILLER

▶ 15-5203	16.0cm	3prongs sharp
▶ 15-5303	16.0cm	3prongs blunt

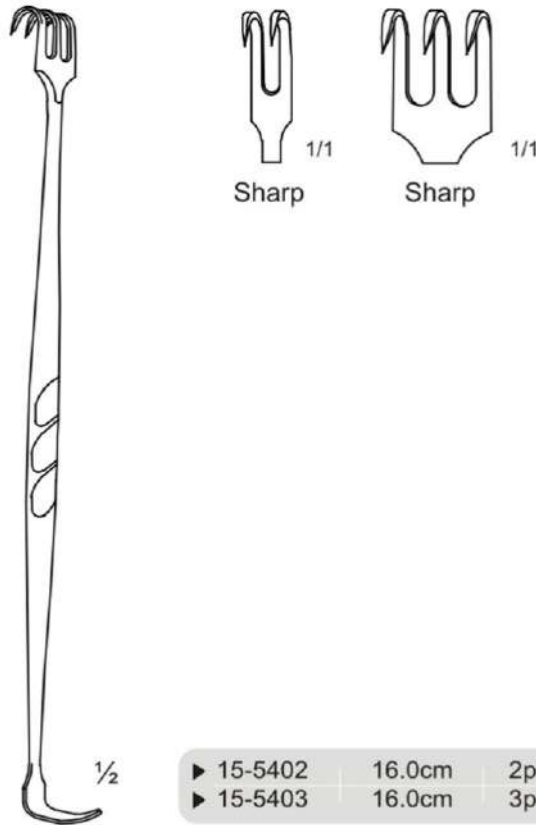

## SENN Flat-handle

▶ 15-5402	16.0cm	2prongs
▶ 15-5403	16.0cm	3prongs

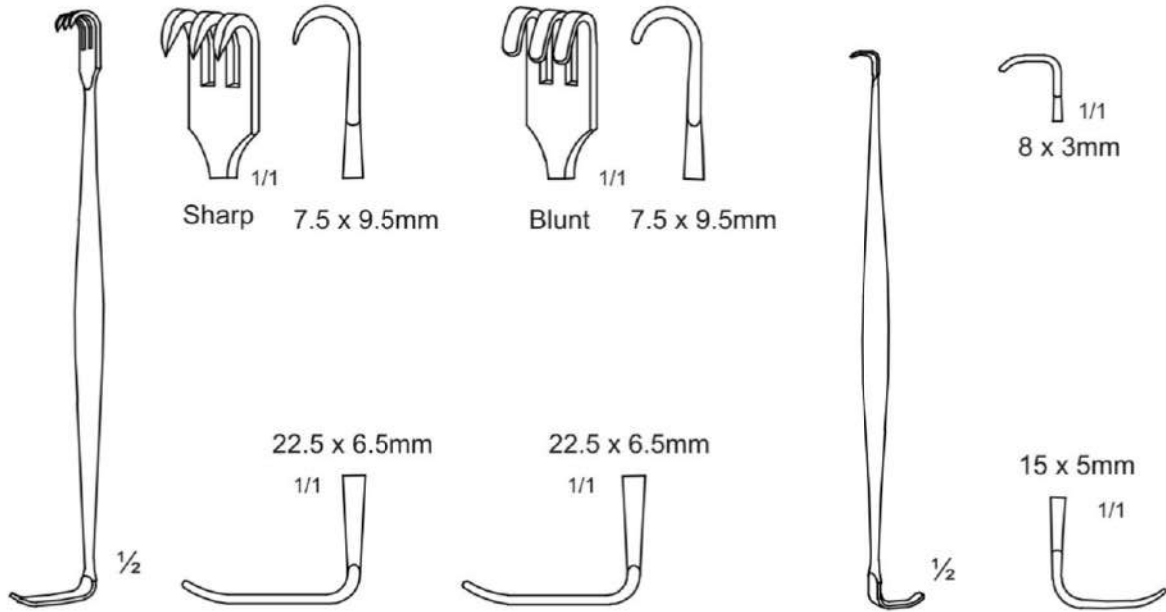

**MATHIEU**

- ▶ 15-5603 16.0cm 3prongs sharp
- ▶ 15-5703 16.0cm 3prongs blunt

**RAGNELL**

- ▶ 15-5800 15.0cm



**MEYERDING**  
Hook for plastic surgery

- ▶ 15-5900 16.0cm



**CRILE**

- 15-6101 11.0cm 6 x 20, 4 x 12mm
- ▶ 15-6102 15.5cm 9 x 25, 6 x 17mm

# Hand Retractors

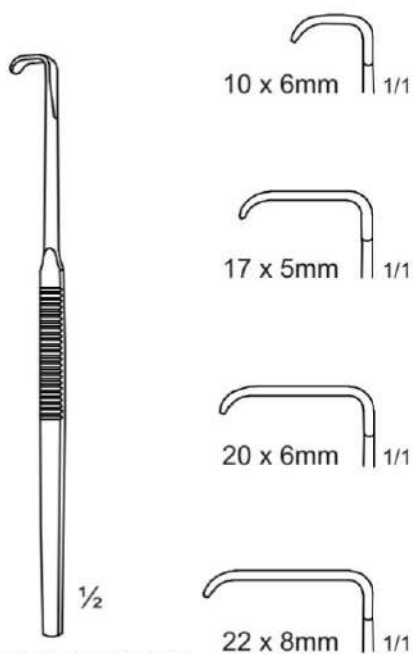

## MINI-LANGENBECK

15-6201	16.0cm	10 x 6mm
15-6202	16.0cm	17 x 5mm
15-6203	16.0cm	20 x 6mm
15-6204	16.0cm	22 x 8mm

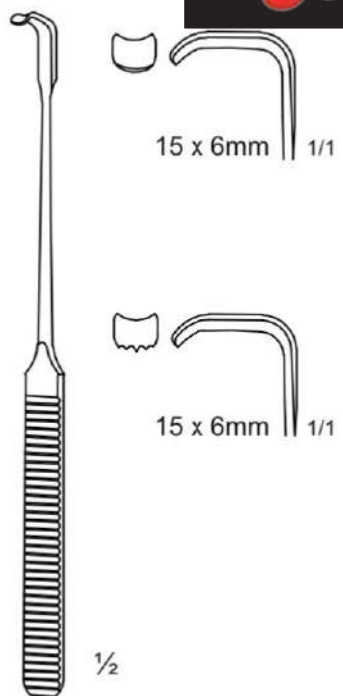

## STRANDELL-STILLE

15-6301	19.0cm	Round tip
15-6302	19.0cm	Toothed tip

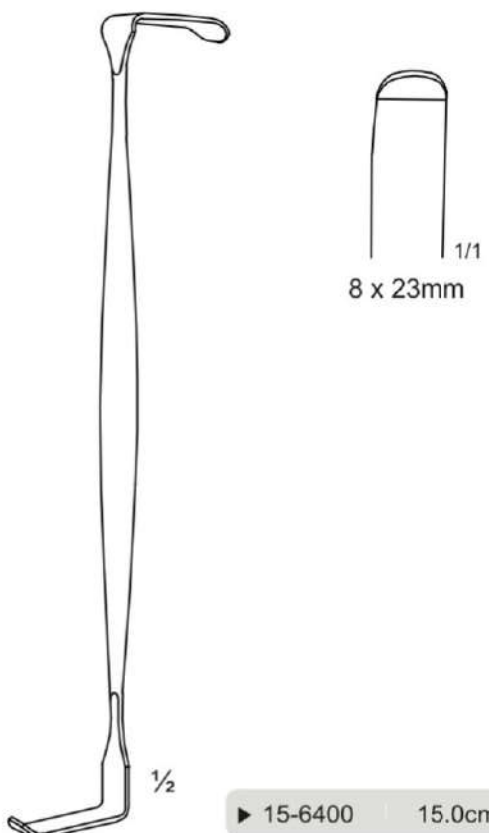

## DAVIS

▶ 15-6400	15.0cm	8 x 23mm
-----------	--------	----------

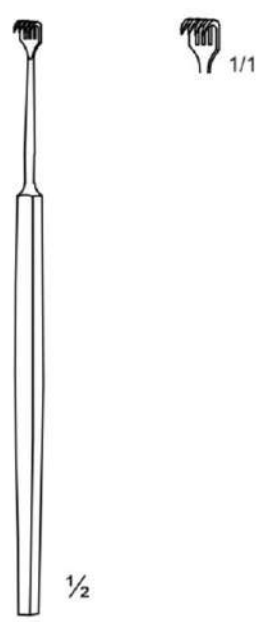

## BLAIR

▶ 15-6500	12.7cm	4prongs
-----------	--------	---------

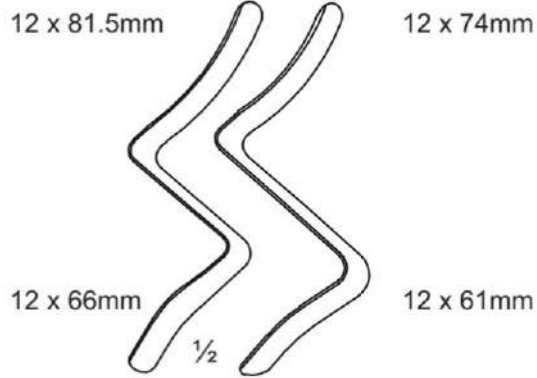
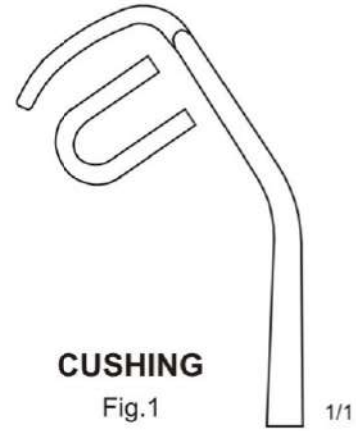

Fig.1 Fig.2

**DOANE**

▶ 15-6601	16.0cm	Fig.1
▶ 15-6602	16.0cm	Fig.2



**CUSHING**

Fig.1

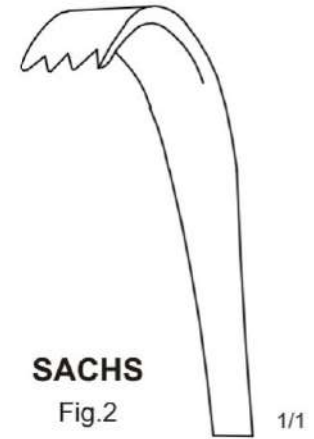

**SACHS**

Fig.2

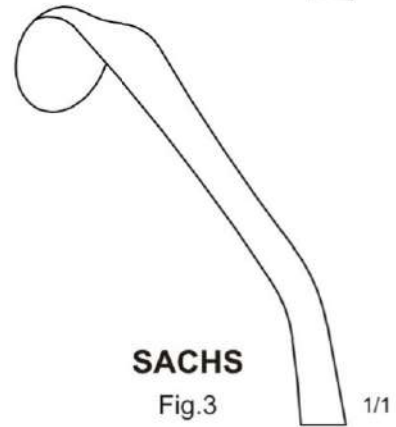

**SACHS**

Fig.3

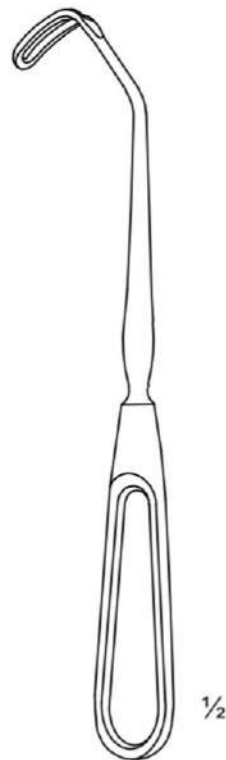

**CUSHING**

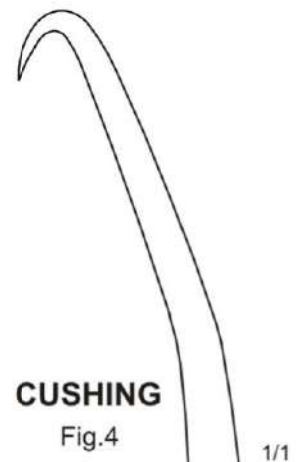

**CUSHING**

Fig.4

▶ 15-6701	20.0cm	Fig.1
▶ 15-6702	20.0cm	Fig.2
▶ 15-6703	20.0cm	Fig.3
▶ 15-6704	20.5cm	Fig.4

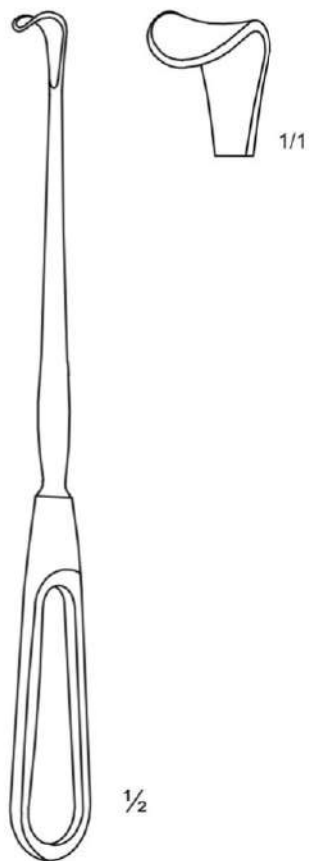

1/2

**CUSHING-VEIN**

► 15-6800 23.0cm 11 x 12mm

15-6901	4.5 x 8mm
15-6902	9 x 10mm
15-6903	9 x 12mm
15-6904	11 x 14mm
15-6905	12 x 16mm
15-6906	13 x 18mm

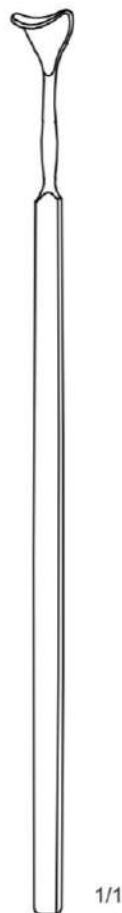

1/1

**CUSHING**



4.5 x 8mm



9 x 10mm



9 x 12mm

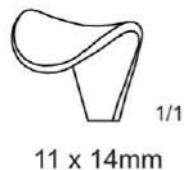

11 x 14mm

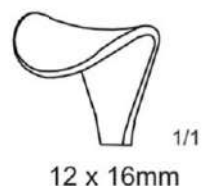

12 x 16mm

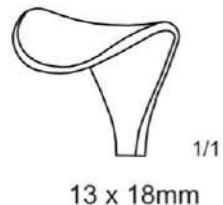

13 x 18mm



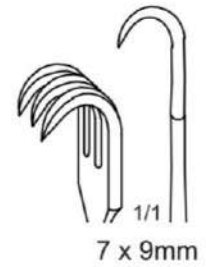
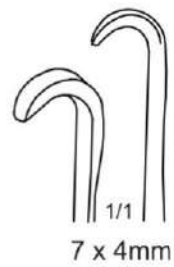
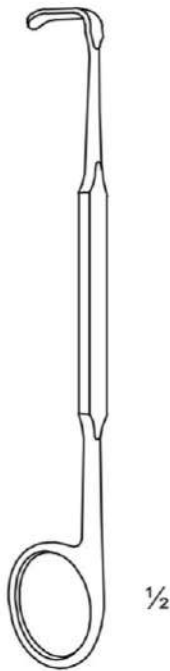

**MEYERDING**

15-7001	18 x 7mm
15-7002	16 x 5mm
15-7003	7 x 4mm
15-7004	10 x 3mm
15-7005	7 x 4mm
15-7006	7 x 9mm

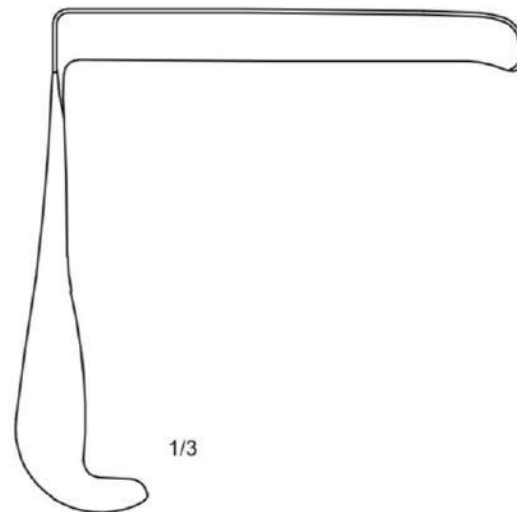

**DEEP**

► 15-7100 | 25.0cm | 30 x 200mm



**MUSCLE ELEVATOR**

used with

▶ 15-8000

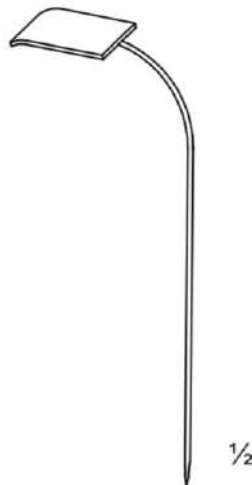

**ENDO**

used with T-Handle

▶ 15-8101	9.2cm	50 x 22mm
▶ 15-8102	9.2cm	50 x 25.4mm
▶ 15-8103	9.2cm	50 x 38mm
▶ 15-8201	10.2cm	60 x 22mm
▶ 15-8202	10.2cm	60 x 25.4mm
▶ 15-8203	10.2cm	60 x 38mm
▶ 15-8301	11.2cm	70 x 22mm
▶ 15-8302	11.2cm	70 x 25.4mm
▶ 15-8303	11.2cm	70 x 38mm

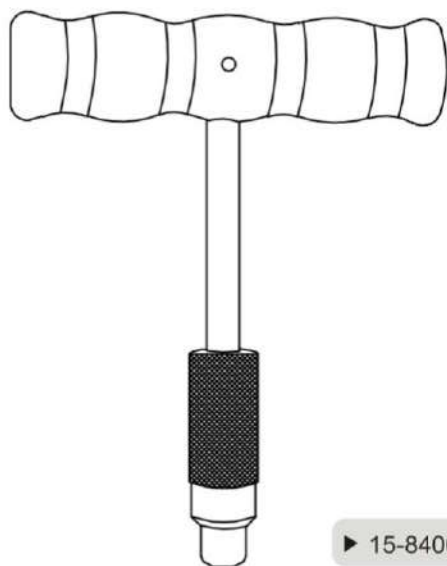

▶ 15-8400 | 10.0cm

**T- HANDLE**

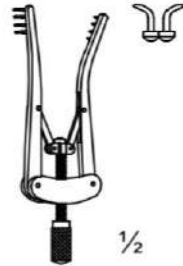

**ALM**

4 x 4prongs

16-0101	7.0cm	Sharp
16-0201	7.0cm	Blunt

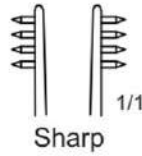

Sharp

1/1

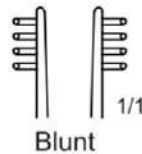

Blunt

1/1

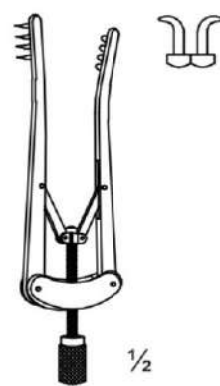

**ALM**

4 x 4prongs

16-0102	10.0cm	Sharp
16-0202	10.0cm	Blunt

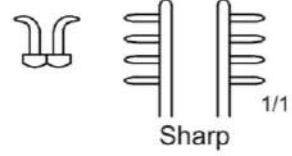

Sharp

1/1

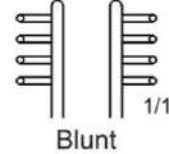

Blunt

1/1

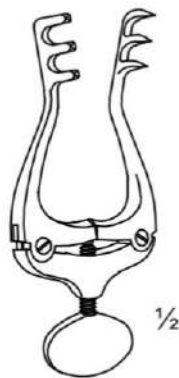

**JANSEN**

3 x 3prongs

16-0300	10.0cm	Sharp
▶ 16-0400	10.0cm	Blunt

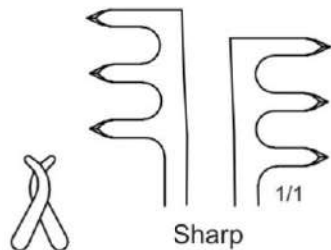

Sharp

1/1

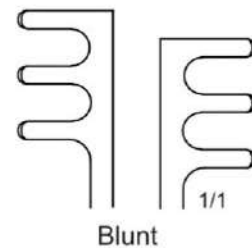

Blunt

1/1

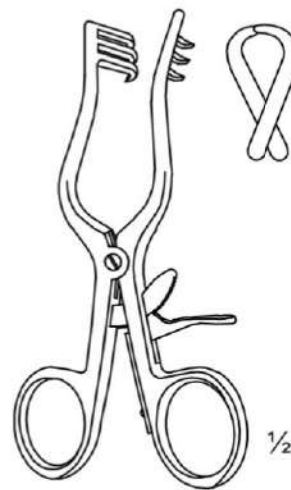

**WULLSTEIN**

3 x 3prongs

16-0500	13.0cm	Sharp
16-0600	13.0cm	Blunt

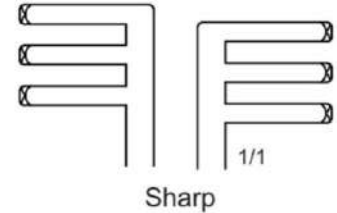

Sharp

1/1

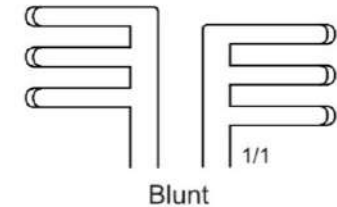

Blunt

1/1

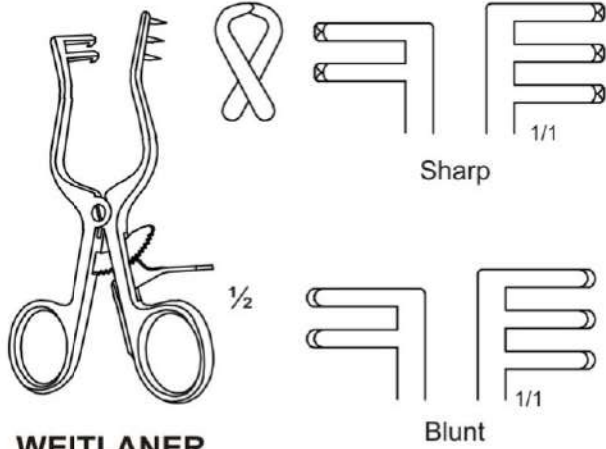

**WEITLANER**  
2 x 3prongs

16-0701	10.5cm	Sharp
16-0801	10.5cm	Blunt

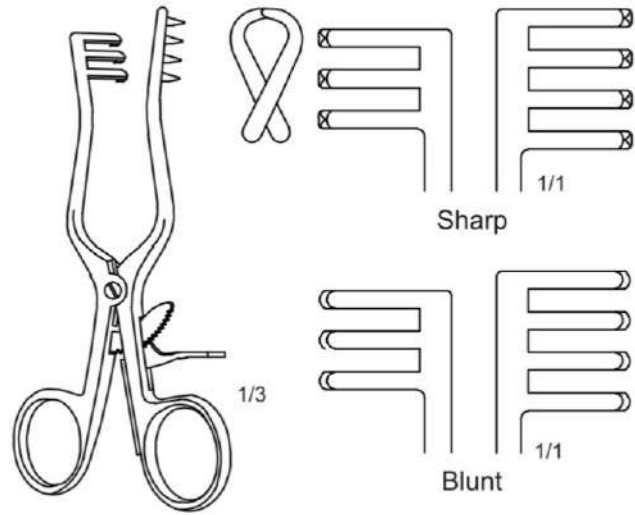

**WEITLANER**  
3 x 4prongs

16-0702	13.0cm	Sharp
16-0802	13.0cm	Blunt

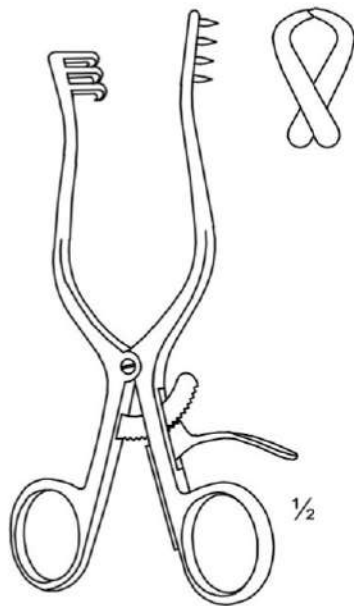

**WEITLANER**  
3 x 4prongs

▶ 16-0703	16.5cm	Sharp
▶ 16-0803	16.5cm	Blunt

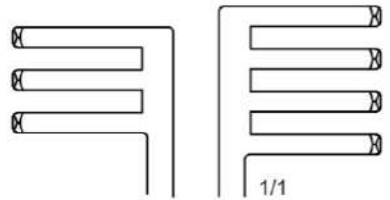
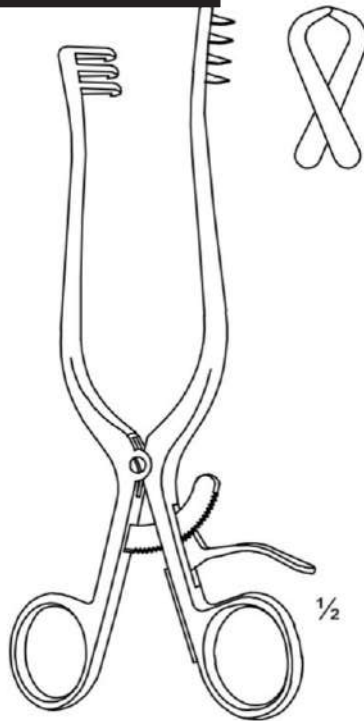

Sharp

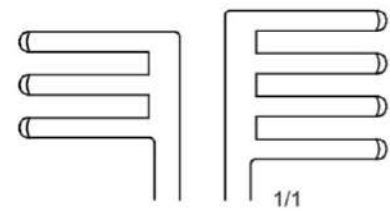

Blunt

**WEITLANER**

3 x 4prongs

- ▶ 16-0704 19.5cm Sharp
- ▶ 16-0804 19.5cm Blunt

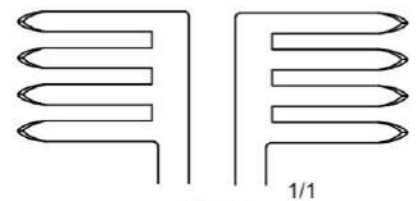

Sharp

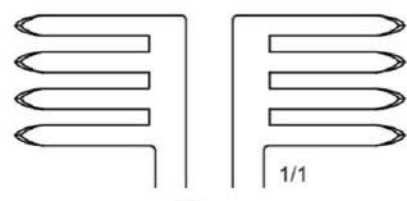
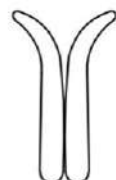
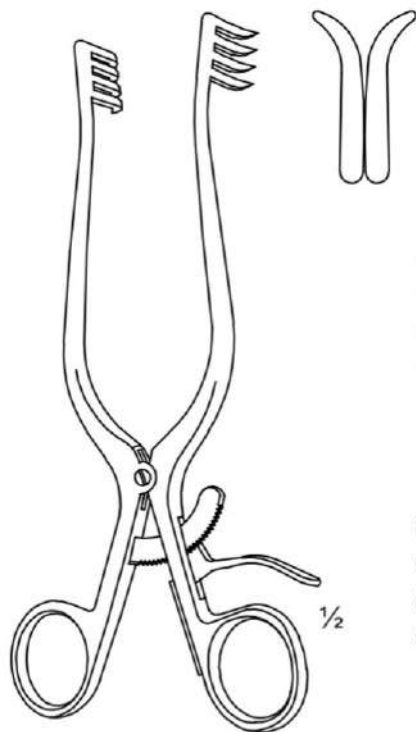

Sharp

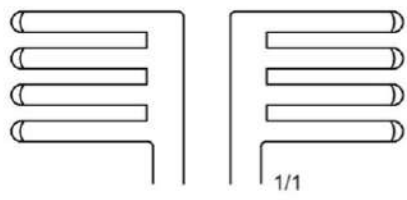

Blunt

**ADSON**

4 x 4prongs

- ▶ 16-0900 19.5cm Sharp
- ▶ 16-1000 19.5cm Blunt

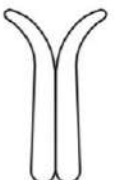
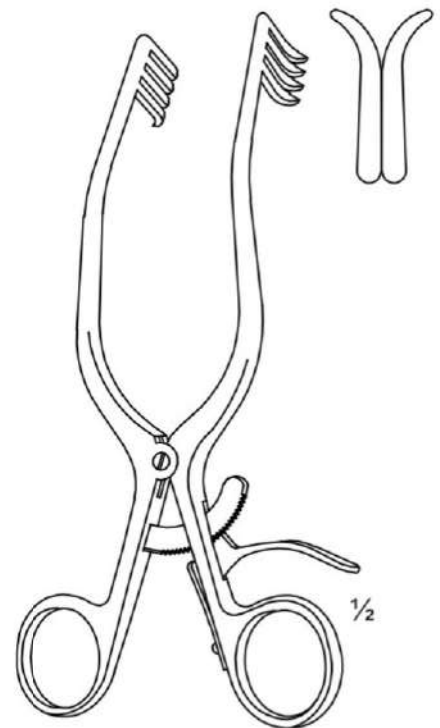

**ANDERSON-ADSON**

- ▶ 16-1100 19.0cm 4 x 4prongs

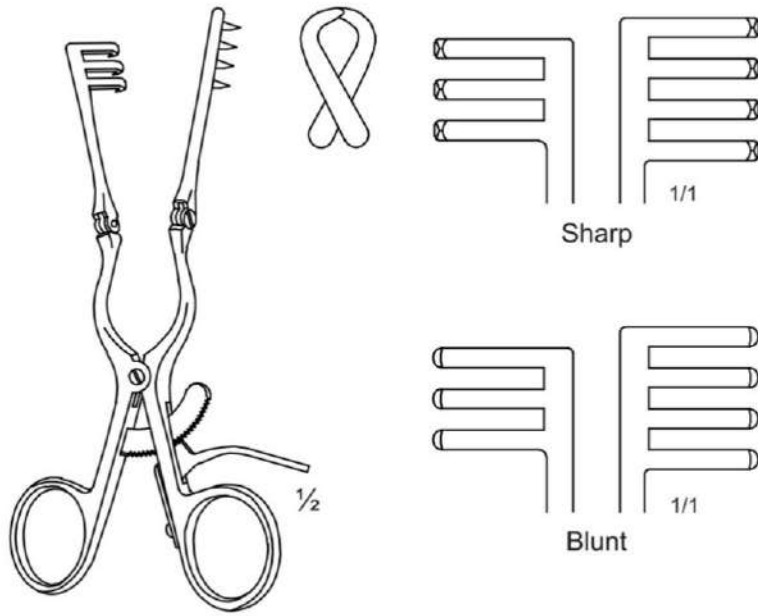

**ADSON**  
3 x 4prongs

16-1201	16.0cm	Sharp
16-1301	16.0cm	Blunt

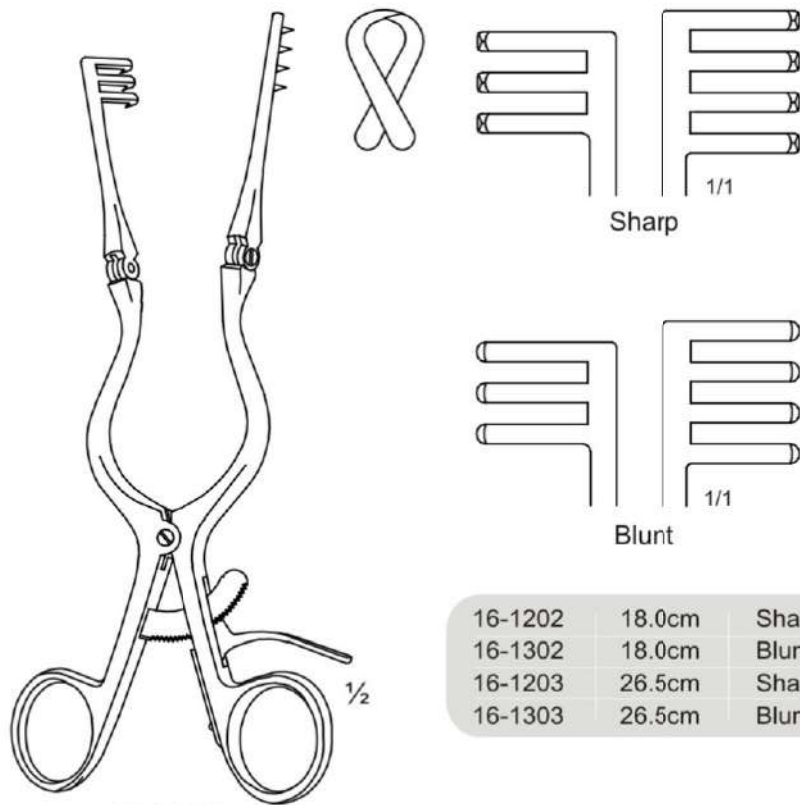

**ADSON**  
3 x 4prongs

16-1202	18.0cm	Sharp
16-1302	18.0cm	Blunt
16-1203	26.5cm	Sharp
16-1303	26.5cm	Blunt



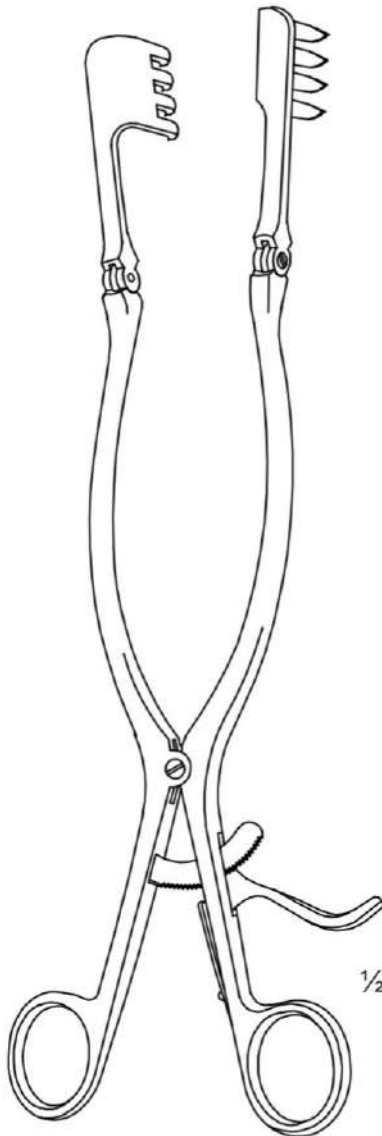
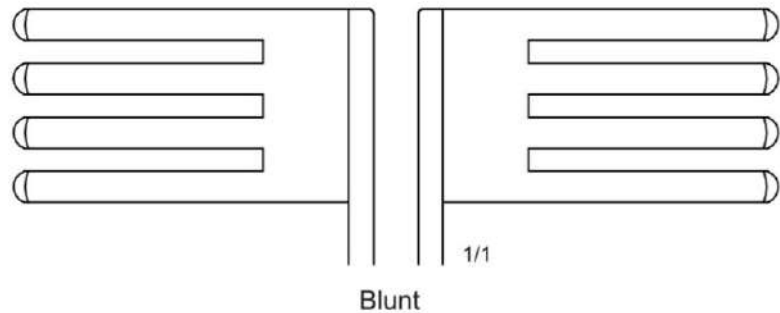
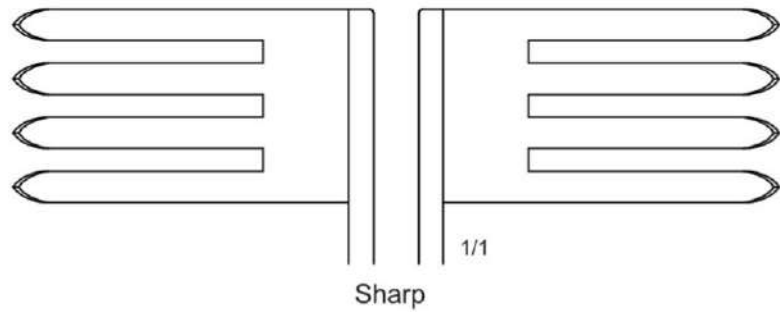
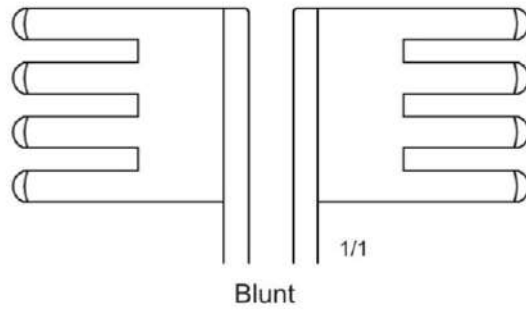
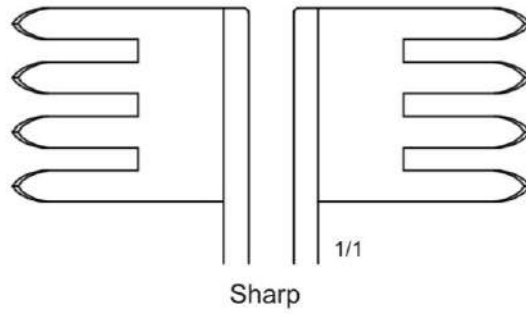
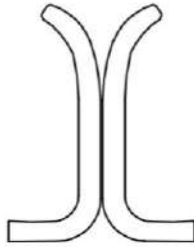

**BECKMANN-ADSON**  
4 x 4prongs

16-1401	Short	Sharp
16-1501	Short	Blunt
16-1402	Long	Sharp
16-1502	Long	Blunt



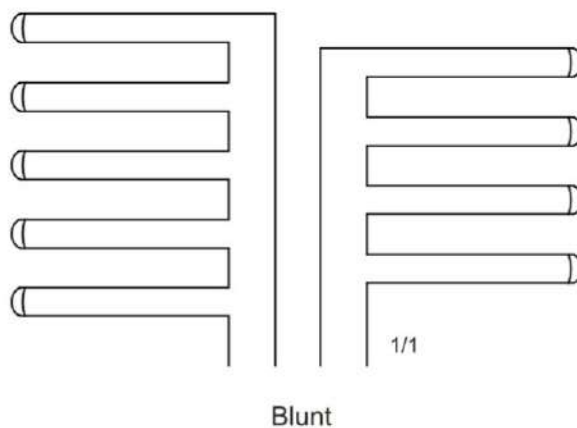
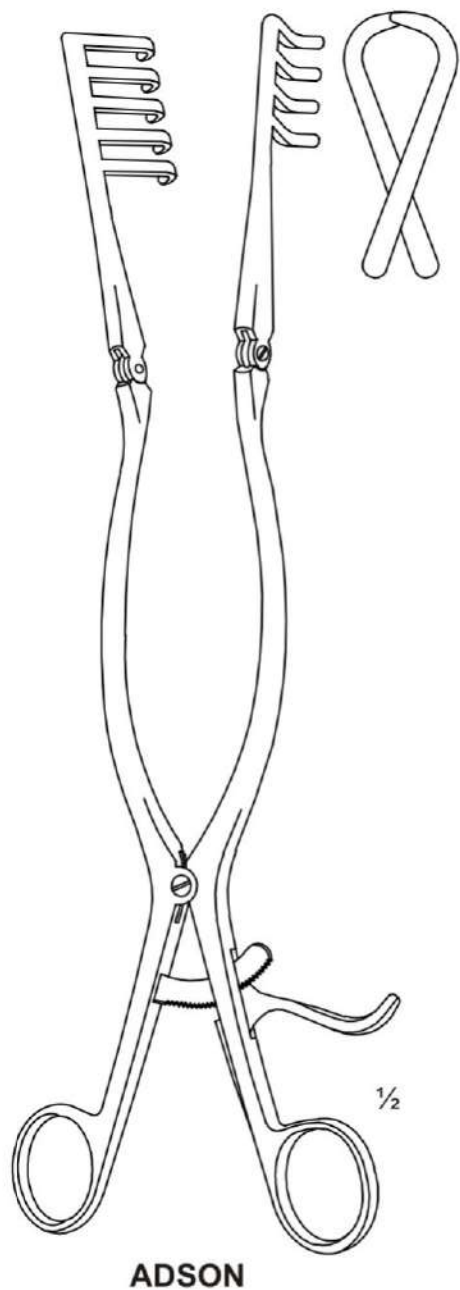

16-1600 32.0cm 4 x 5prongs

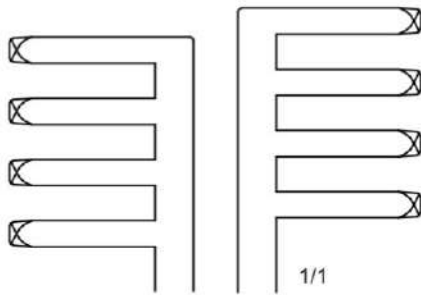

Sharp

1/1

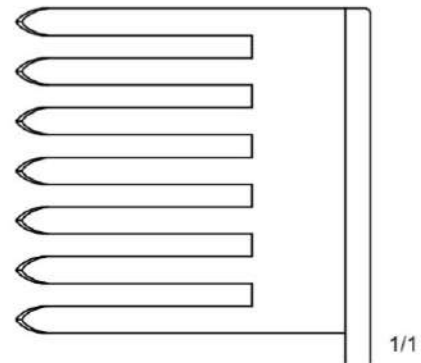

Sharp

1/1

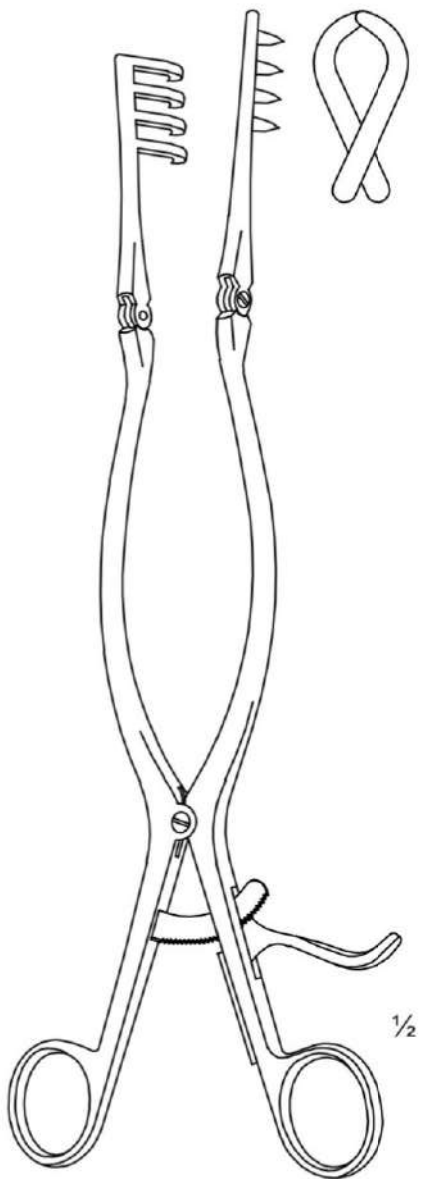

1/2

**BECKMANN**

16-1700 | 31.5cm | 4 x 4prongs

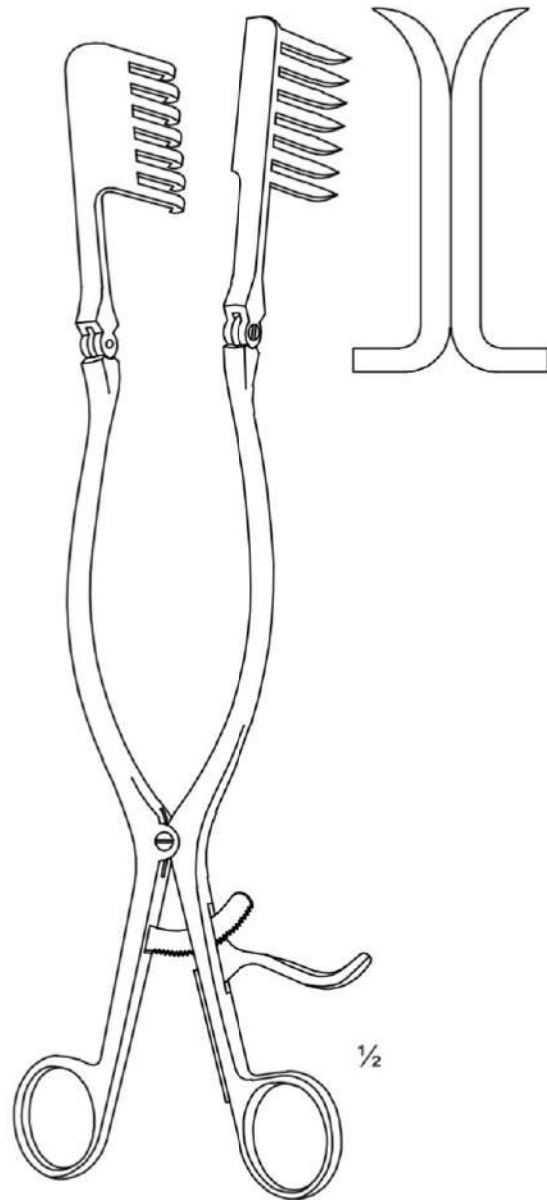

1/2

**BECKMANN-EATON**

16-1800 | 32.0cm

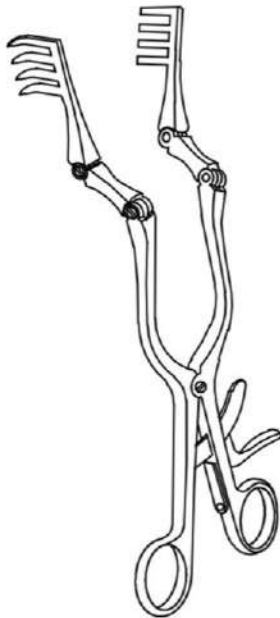

**BECKMANN**  
Double Hindged

16-1901	25.0cm	Sharp
16-1902	31.0cm	Sharp

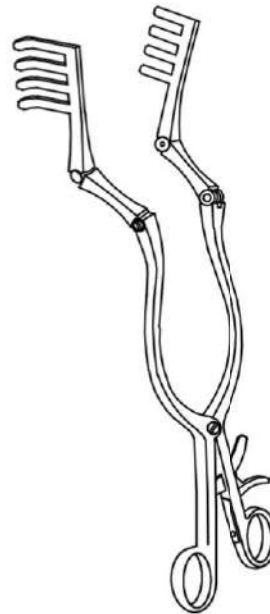

**BECKMANN**  
Double Hindged

16-2001	25.0cm	Blunt
16-2002	31.0cm	Blunt

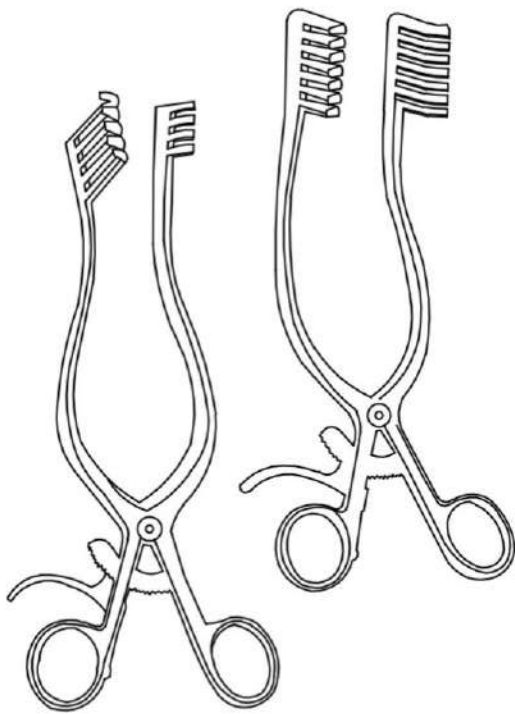

**MISKIMON**  
Blunt

▶ 16-2101	21.5cm	4 x 5prongs
▶ 16-2102	21.5cm	7 x 7prongs

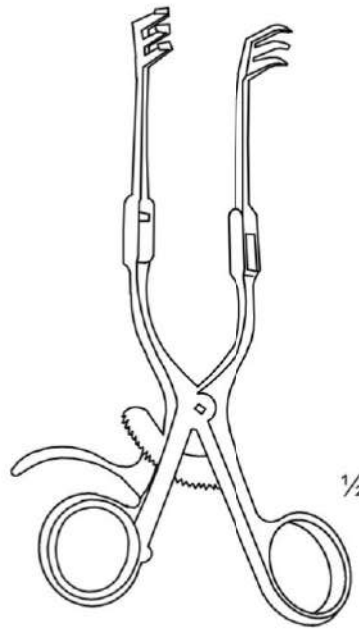

**FISCH MASTOID**  
Sharp

▶ 16-2200	16.5cm	3 x 3prongs
-----------	--------	-------------

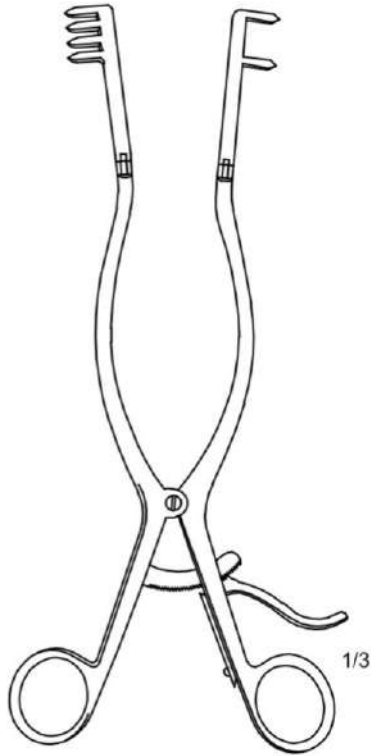

**HORIZONTAL**  
Sharp

▶ 16-2300 31.0cm 4 x 2prongs

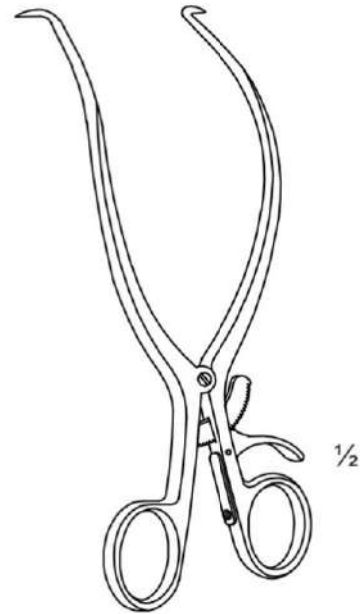

**GELPI**

▶ 16-2401 13.0cm  
▶ 16-2402 19.0cm

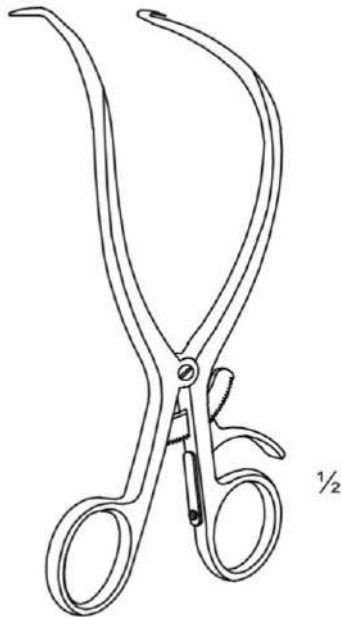

**GELP-LOKTITE**

▶ 16-2501 16.0cm  
▶ 16-2502 17.5cm

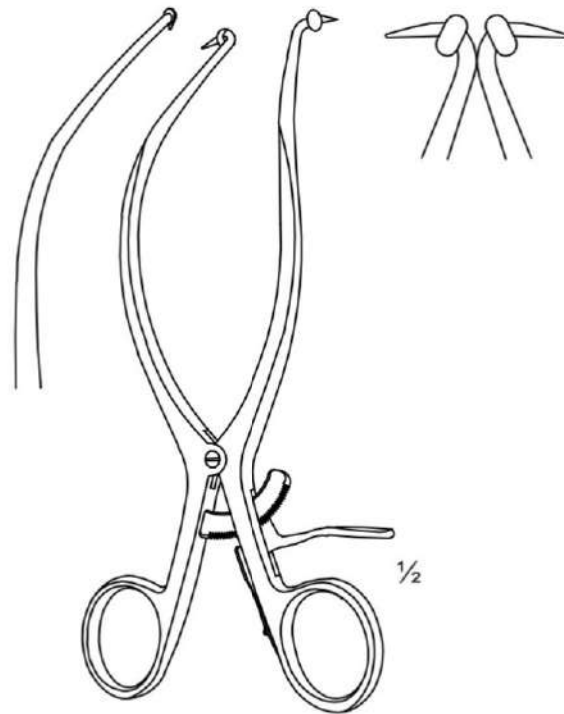

**GELPI**  
with ball stop

▶ 16-2600 19.0cm

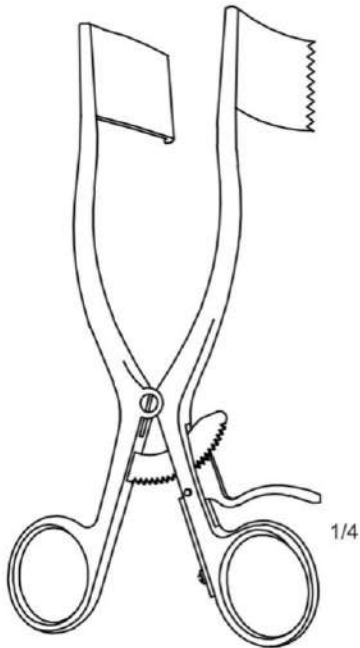

**MEYERDING**

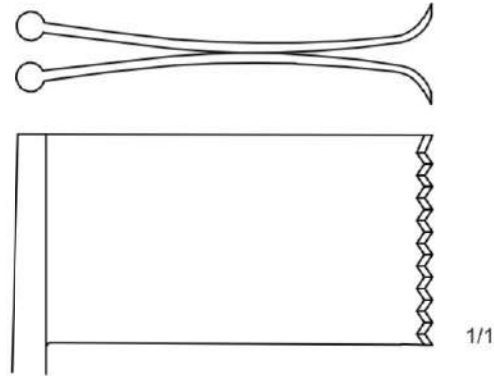

▶ 16-2701	18.0cm	20 x 62prongs
▶ 16-2702	18.0cm	25 x 32prongs
▶ 16-2703	18.0cm	25 x 52prongs
▶ 16-2704	18.0cm	25 x 62prongs

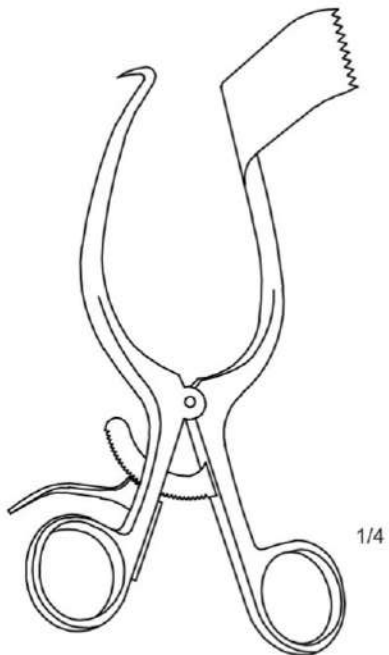

**MARKHARM-MEYERDING**

▶ 16-2801 | 19.8cm | Left

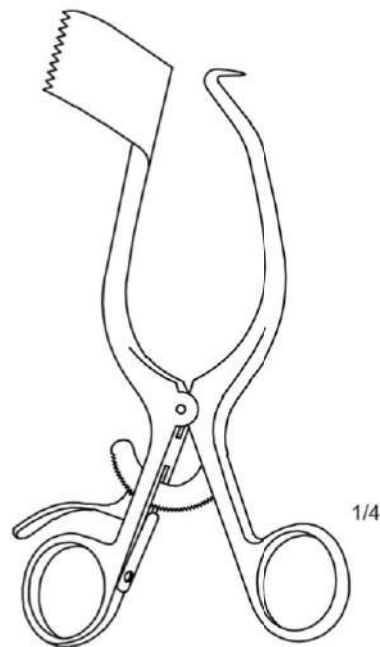

**MARKHARM-MEYERDING**

▶ 16-2802 | 19.8cm | Right

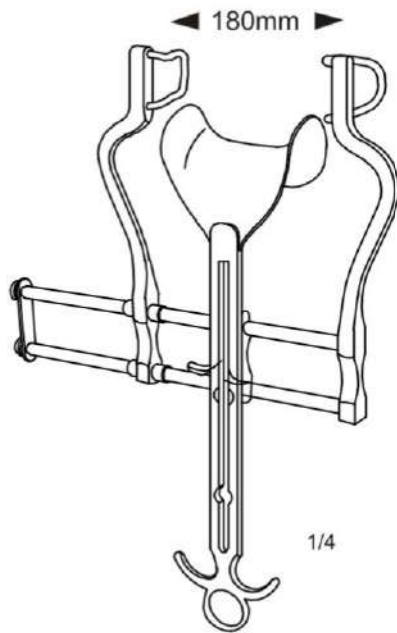

**BALFOUR**

▶ 16-2901	Central blades	45 x 80mm
	lateral blades	63mm

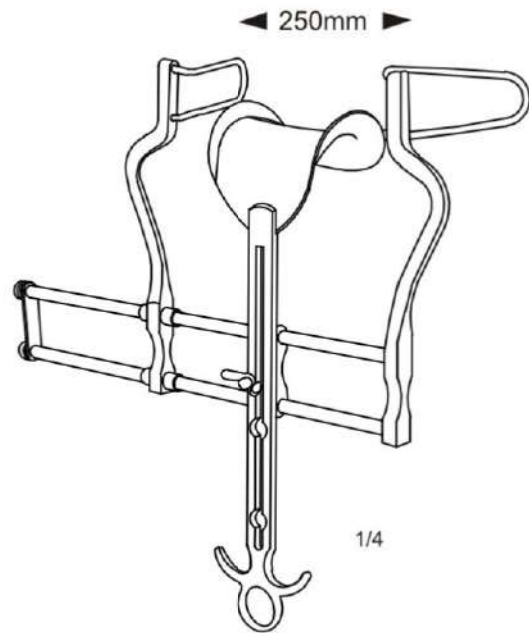

**BALFOUR**

▶ 16-2902	Central blades	70 x 85mm
	lateral blades	100mm

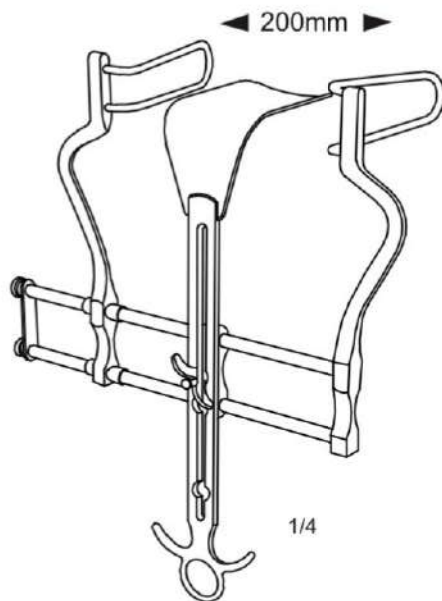

**BALFOUR**

▶ 16-2903	Central blades	100 x 70mm
	lateral blades	100mm

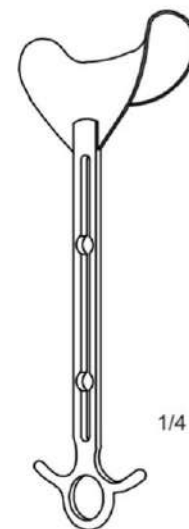

**BALFOUR**

Central blade only

▶ 16-2910	45 x 80mm
▶ 16-2920	70 x 85mm
▶ 16-2930	90 x 90mm



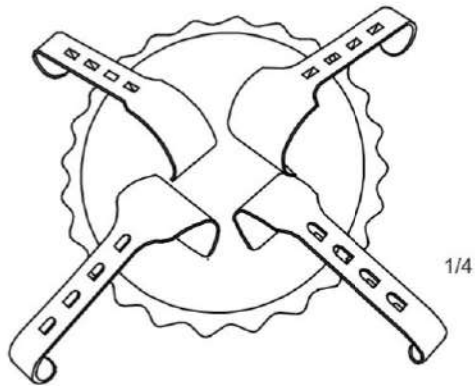

**DENIS-BROWNE SET**

Consist of  
 Frame 180 x 150mm  
 1 Pair Blade 40 x 30mm  
 1 Pair Blade 40 x 40mm

▶ 16-3000	180 x 150mm	Set
▶ 16-3001	180 x 150mm	Frame
▶ 16-3002	40 x 30mm	Blade
▶ 16-3003	40 x 40mm	Blade

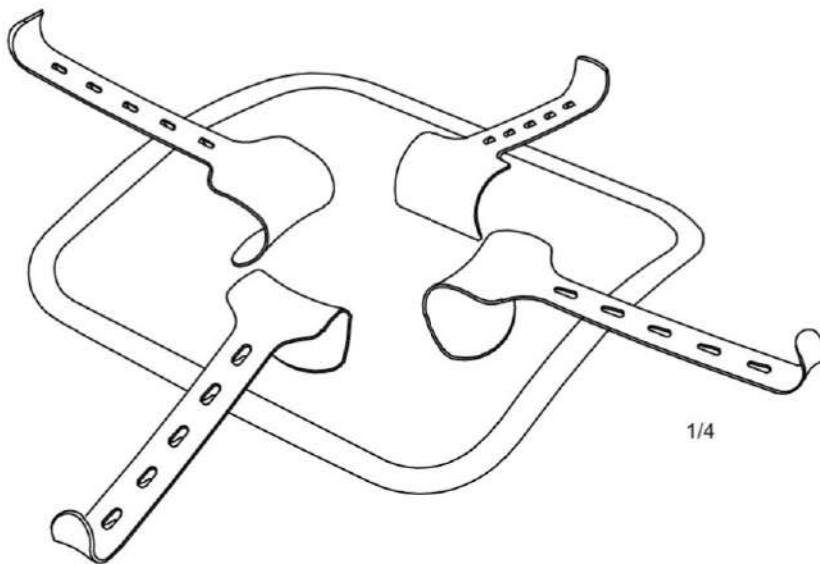

**DENIS-BROWNE SET**

Consist of  
 Frame 255 x 255mm  
 1 Pair Blade 40 x 55mm  
 1 Pair Blade 50 x 65mm

▶ 16-3100		Set
▶ 16-3101	255 x 255mm	Frame
▶ 16-3102	40 x 55mm	Blade
▶ 16-3103	50 x 65mm	Blade



◀ 80mm ▶

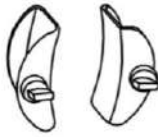

16-3200		Set
16-3201	18.0cm	Spreader
16-3210	18 x 40mm	Blade
16-3220	28 x 40mm	Blade

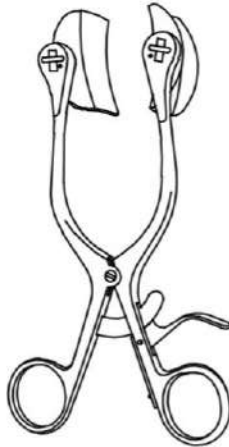

1/3

## BABY-COLLIN SET

Consist of

- 1 spreader
- 1 Pair lateral Blade 18 x 40mm
- 1 Pair lateral Blade 28 x 40mm

◀ 98mm ▶

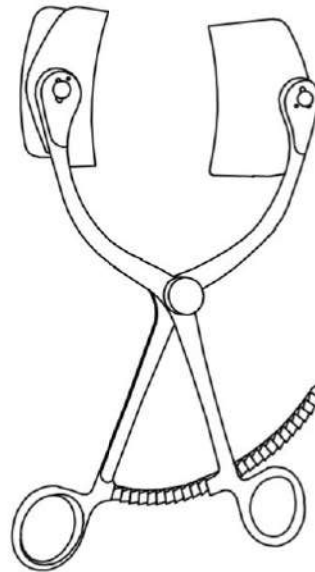

1/3

## COLLIN

▶ 16-3300 38 x 60mm Blade

◀ 95mm ▶

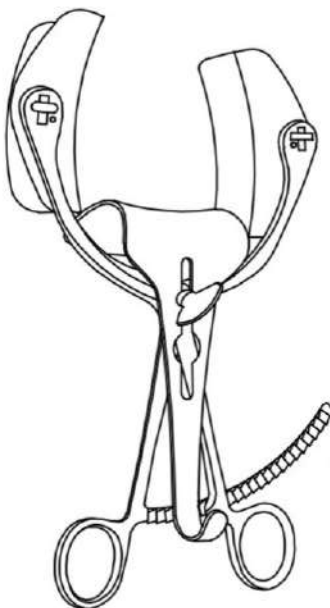

1/3

## COLLIN

16-3401	Central blade	38 x 55mm
	lateral blades	38 x 60mm
16-3402	Central blade	50 x 75mm
	lateral blades	38 x 80mm

◀ 160mm ▶

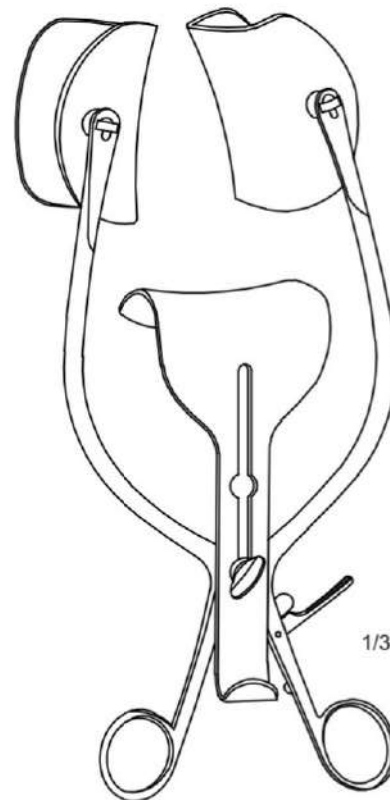

1/3

## COLLIN-LOKTITE

▶ 16-3500 60 x 75mm, 60 x 80mm



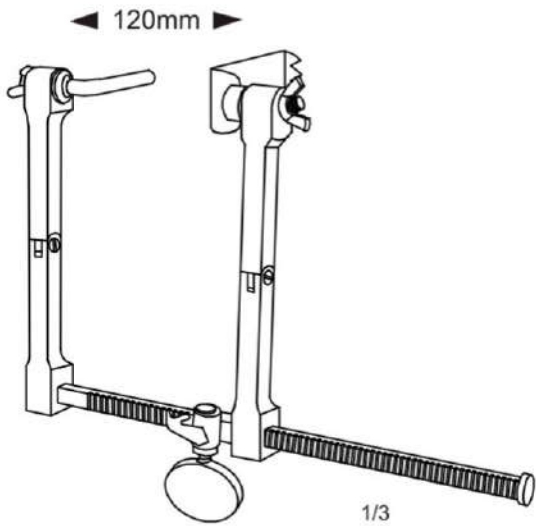

- ▶ 16-3600 Set
- ▶ 16-3601 120mm spread Frame

**SCOVILLE-HAVERFIELD SET**

Consist of

- 1 Frame
- 1 Hook 50mm
- 1 Lateral valve 63 x 25mm

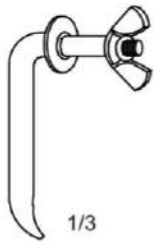

**SCOVILLE**

- ▶ 16-3610 50mm
- ▶ 16-3611 75mm



**TAYLOR**

- ▶ 16-3620 41 x 38mm
- ▶ 16-3621 67 x 44mm

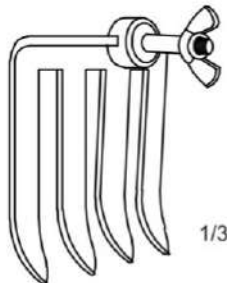

- 16-3630 48 x 50mm
- 16-3631 64 x 63mm
- 16-3632 80 x 57mm



- ▶ 16-3640 63 x 25mm
- ▶ 16-3650 63 x 50mm
- ▶ 16-3660 88 x 25mm

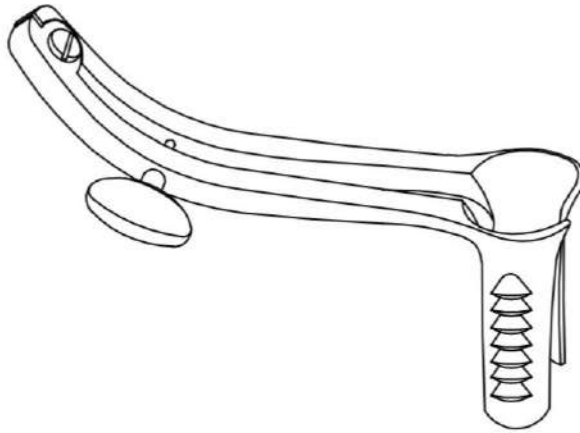

16-3701	45mm
16-3702	50mm
16-3703	55mm
16-3704	60mm
16-3705	65mm

**CASPAR**  
Specula

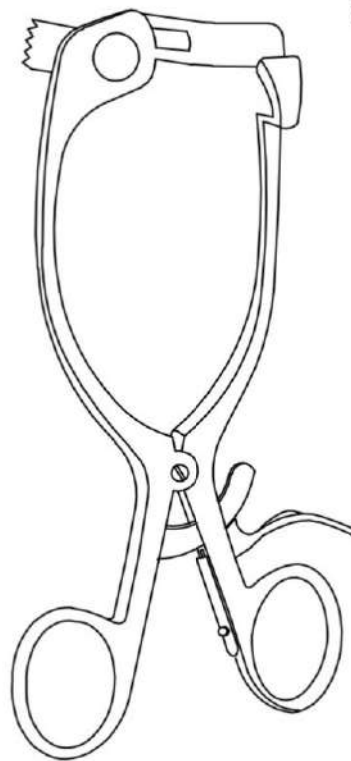

16-3800	Counter Retractor Complete with 7 blades(016-3840-3870)
16-3801	Counter Retractor, Only

**CASPAR**



16-3840	40mm
16-3845	45mm
16-3850	50mm
16-3855	55mm
16-3860	60mm
16-3865	65mm
16-3870	70mm

**CASPAR BLADE**

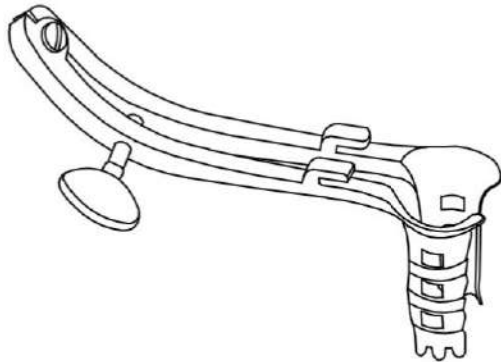

**CASPAR**  
Specula

16-3901	40mm
16-3902	45mm
16-3903	50mm
16-3904	55mm
16-3905	60mm
16-3906	65mm
16-3907	75mm
16-3908	85mm

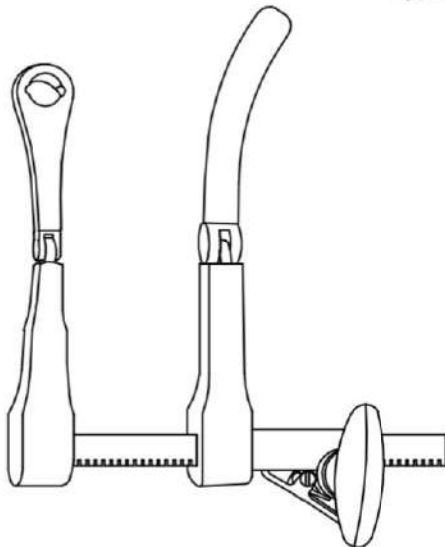

**CASPAR**

16-4000	Counter Retractor Complete with 6 blades(016-4035~4060)
16-4001	Counter Retractor, Only



**CASPAR BLADE**

16-4035	35mm
16-4040	40mm
16-4045	45mm
16-4050	50mm
16-4055	55mm
16-4060	60mm
16-4065	65mm
16-4075	75mm
16-4085	85mm

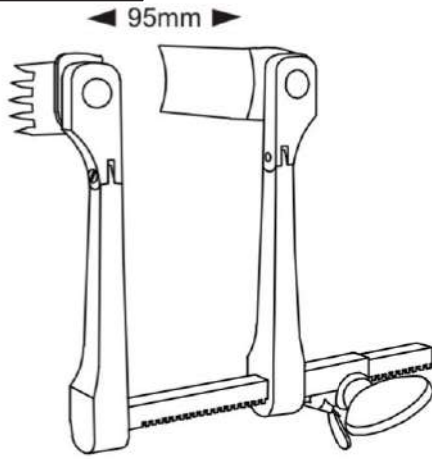

**CASPAR**

- 16-4100 Retractor, with 10 blades(016-4140-4160, 016-4240-4260)
- 16-4101 Retractor, Only

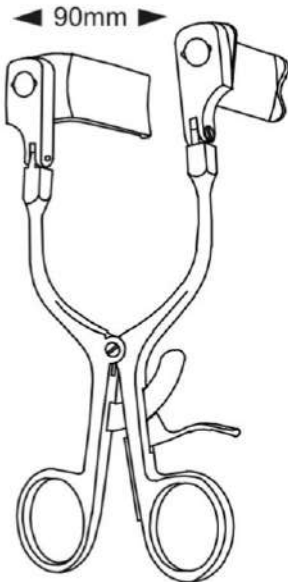

**CASPAR**

- 16-4200 Counter Retractor, with 5 blades(016-4345-4365)
- 16-4201 Counter Retractor, Only

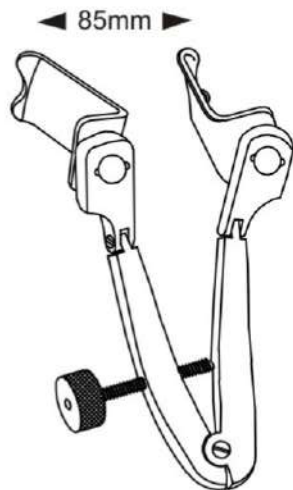

**CASPAR**

- 16-4300 Counter Retractor, with 5 blades(016-4345-4365)
- 16-4301 Counter Retractor, Only

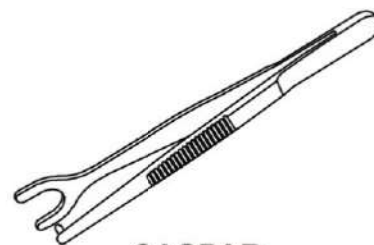

**CASPAR**  
Blade ejector

- 16-4400 11.5cm



**CASPAR-BLADE**

16-4140	40 x 23mm
16-4145	45 x 23mm
16-4150	50 x 23mm
16-4155	55 x 23mm
16-4160	60 x 23mm

16-4125T	25 x 24mm
16-4130T	30 x 24mm
16-4135T	35 x 24mm
16-4140T	40 x 24mm
16-4145T	45 x 24mm
16-4150T	50 x 24mm
16-4155T	55 x 24mm
16-4160T	60 x 24mm
16-4165T	65 x 24mm
16-4170T	70 x 24mm

**TITANIUM**

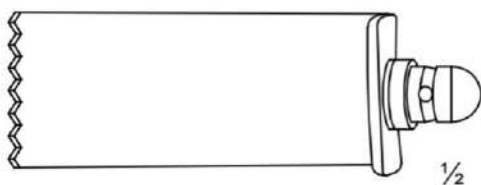

**CASPAR-BLADE**

16-4240	40 x 23mm
16-4245	45 x 23mm
16-4250	50 x 23mm
16-4255	55 x 23mm
16-4260	60 x 23mm

16-4225T	25 x 24mm
16-4230T	30 x 24mm
16-4235T	35 x 24mm
16-4240T	40 x 24mm
16-4245T	45 x 24mm
16-4250T	50 x 24mm
16-4255T	55 x 24mm
16-4260T	60 x 24mm
16-4265T	65 x 24mm
16-4270T	70 x 24mm

**TITANIUM**

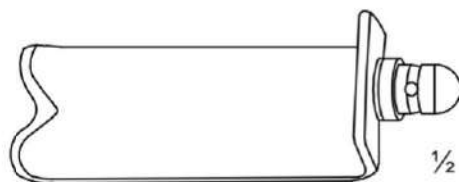

**CASPAR-BLADE**

16-4345	45 x 23mm
16-4350	50 x 23mm
16-4355	55 x 23mm
16-4360	60 x 23mm
16-4365	65 x 23mm

16-4325T	25 x 24mm
16-4330T	30 x 24mm
16-4335T	35 x 24mm
16-4340T	40 x 24mm
16-4345T	45 x 24mm
16-4350T	50 x 24mm
16-4355T	55 x 24mm
16-4360T	60 x 24mm
16-4365T	65 x 24mm
16-4370T	70 x 24mm

**TITANIUM**

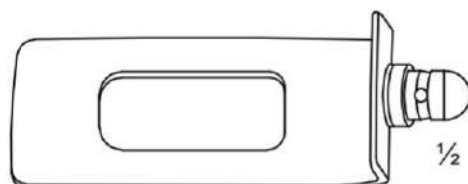

**CASPAR-BLADE**

16-4450	50 x 25mm
16-4460	60 x 25mm



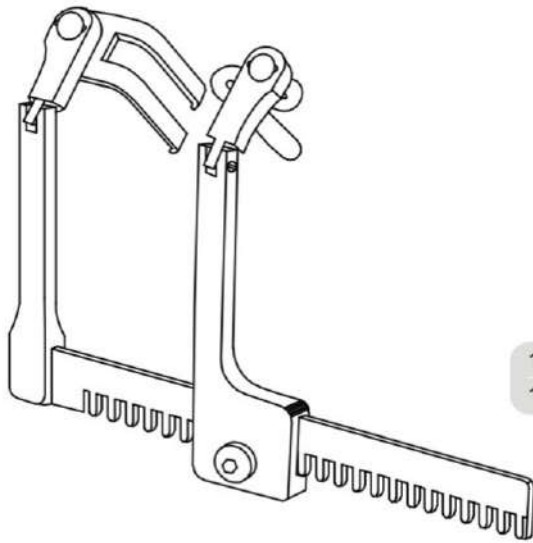

16-4500	Retractor, with hook (016-4510) and 10 blades(016-4637~4657)
16-4501	Retractor, Only

## CASPAR



### CASPAR-HOOK

16-4510	38mm	Hook
16-4520	58mm	Hook

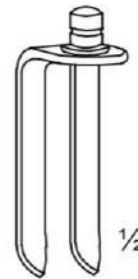

### CASPAR-BLADE

16-4632	32 x 22mm
16-4637	37 x 22mm
16-4643	43 x 22mm
16-4647	47 x 22mm
16-4652	52 x 22mm
16-4657	57 x 22mm
16-4662	62 x 22mm
16-4667	67 x 22mm

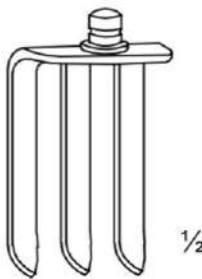

### CASPAR-BLADE

16-4732	32 x 37mm
16-4737	37 x 37mm
16-4743	43 x 37mm
16-4747	47 x 37mm
16-4752	52 x 37mm
16-4757	57 x 37mm
16-4762	62 x 37mm
16-4767	67 x 37mm

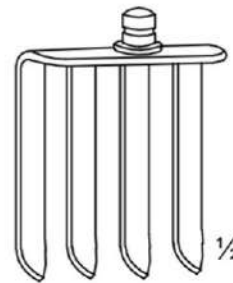

### CASPAR-BLADE

16-4832	32 x 52mm
16-4837	37 x 52mm
16-4843	43 x 52mm
16-4847	47 x 52mm
16-4852	52 x 52mm
16-4857	57 x 52mm
16-4862	62 x 52mm
16-4867	67 x 52mm



# Self-Retaining Retractors

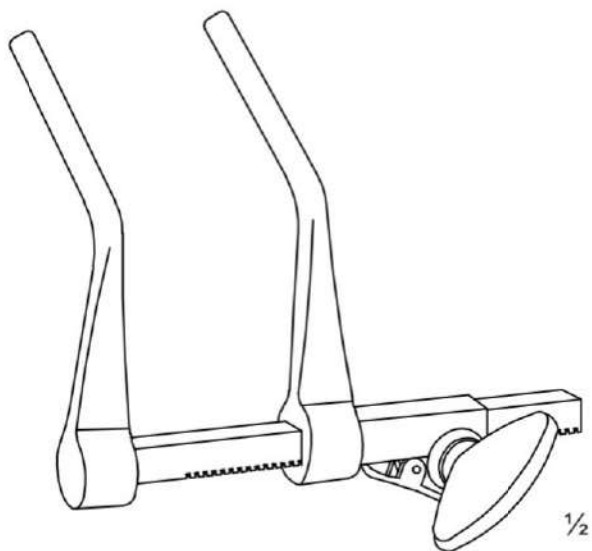

## CASPAR

- 16-4901 Distractor only, right
- 16-4902 Distractor only, left
- 16-4903 Distractor only, right with toothed bar
- 16-4904 Distractor only, left toothed bar

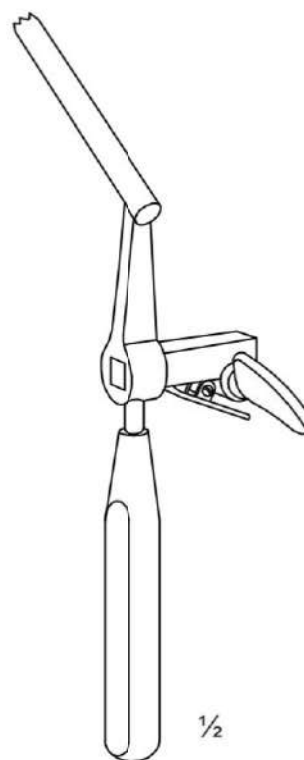

## CASPAR

- 16-5001 Drill guide, right, for distractor 016-4901
- 16-5002 Drill guide, left, for distractor 016-4902

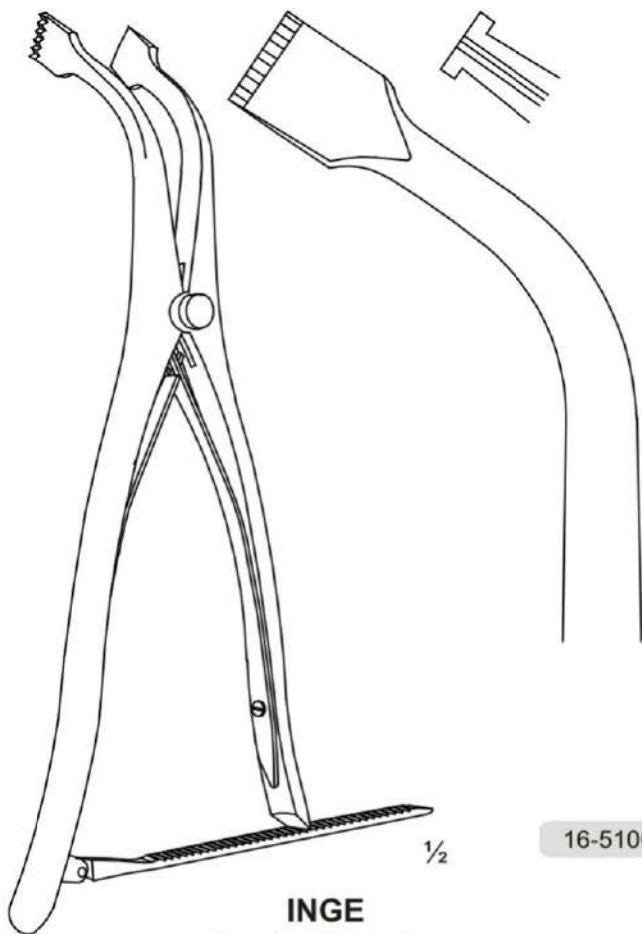

## INGE Lamina Spreader

16-5100 27.0cm





**Hooks**  
Hooks



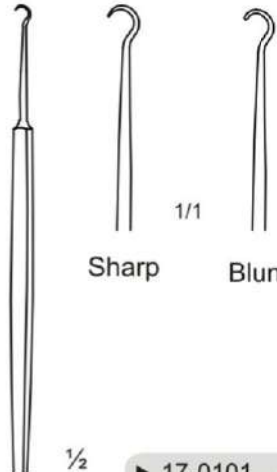

1/2

**FRAZIER**

▶ 17-0101	13.0cm	Sharp
17-0102	18.0cm	Sharp
17-0201	13.0cm	Blunt
17-0202	18.0cm	Blunt

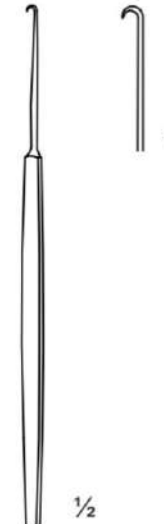

1/1

1/2

**CUSHING**

▶ 17-0300 14.0cm



1/1

1/2

**TOENNIS**

17-0500 15.0cm



1/1

1/2

**SACHS**

17-0600 18.5cm

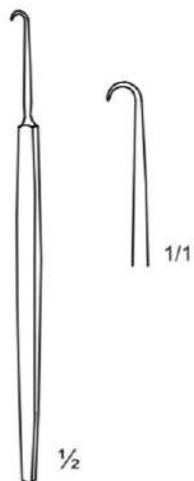

**O'CONNOR**

▶ 17-0700 12.0cm

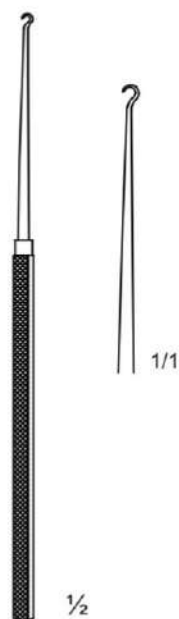

**KILNER**

17-0800 15.0cm

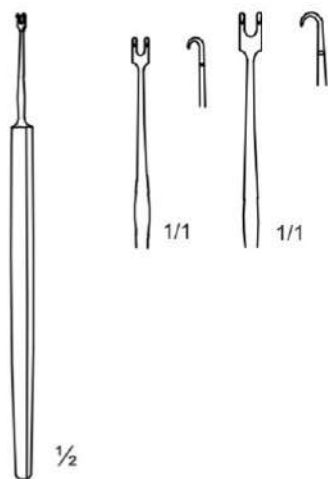

**GUTHRIE**

▶ 17-0901 12.0cm  
▶ 17-0902 13.0cm

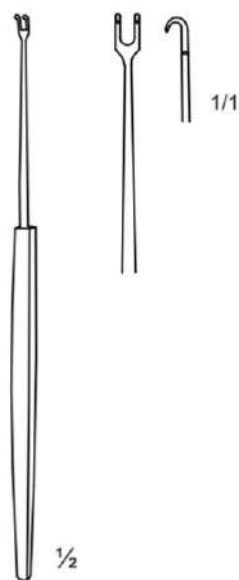

**FREER**

17-1000 15.0cm

▶ 17-1101 15.0cm

▶ 17-1102 2mm  
▶ 17-1103 5mm  
▶ 17-1104 7mm  
▶ 17-1105 10mm

**JOSEPH**  
Skin Hooks

**JOSEPH**  
Skin Hooks



**IRIS**

1/1 1/1 1/1

**KUGLEN**

- ▶ 17-1201 Straight
- ▶ 17-1202 Curved
- ▶ 17-1203 Straight, Blunt

1/1 1/1

1.0mm  
**SHEPARD**

- ▶ 17-1301 Straight, Blunt
- ▶ 17-1302 Curved, Blunt

1/1 1/1

0.15mm  
**JAFFE**      **CLAYMANN-JAFFE**

- ▶ 17-1401 Straight, Blunt
- ▶ 17-1402 Curved, Blunt

1/1 1/1

**BONN**

- ▶ 17-1501 Straight, Blunt
- ▶ 17-1502 Curved, Blunt

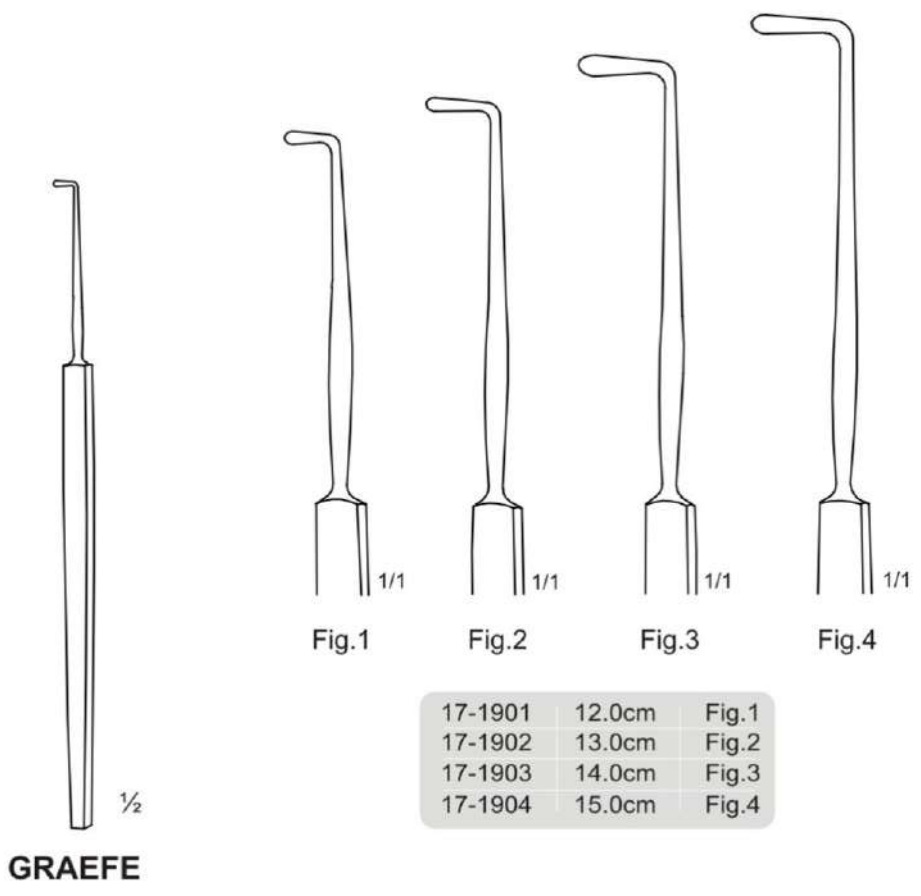
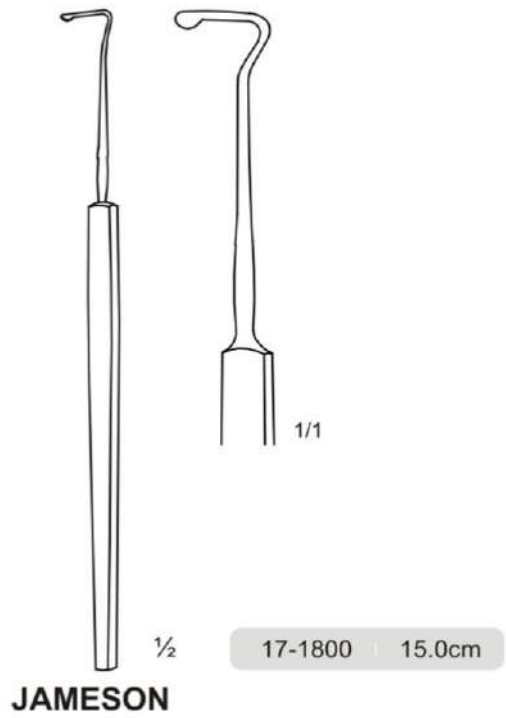
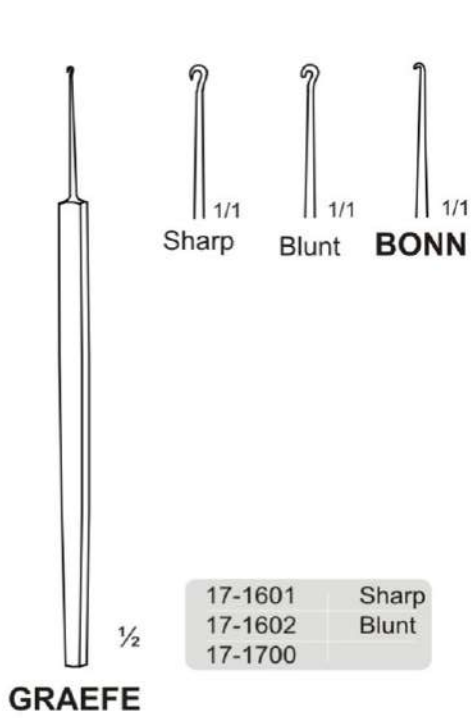



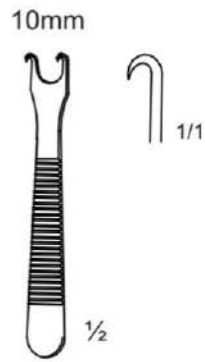

**KILNER**

17-2000 10.0cm

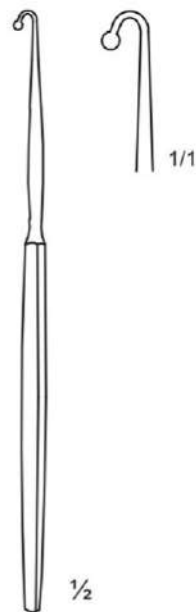

**FOMON**

17-2200 17.0cm

**LANGE**

17-2300 22.0cm

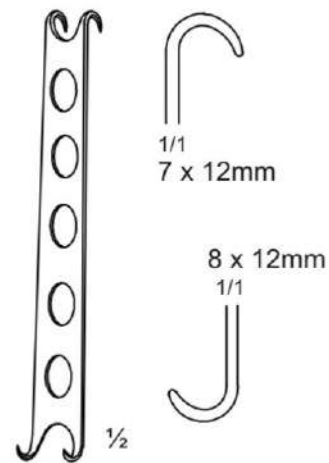

**CONVERSE**

Blunt

17-2100 12.0cm

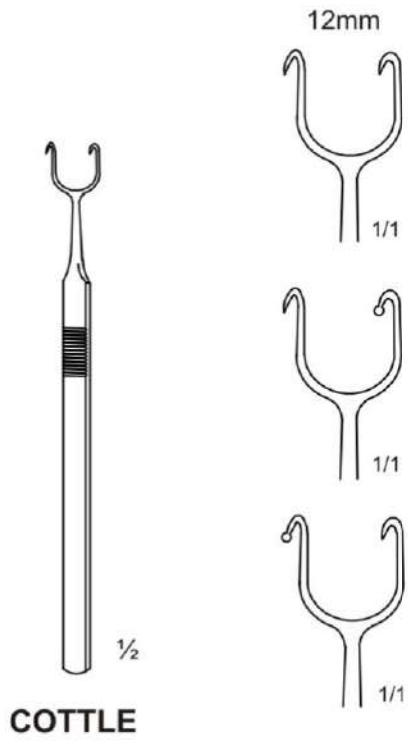

17-2401	Two-Sharp
17-2402	Sharp-Left
17-2403	Sharp-Right

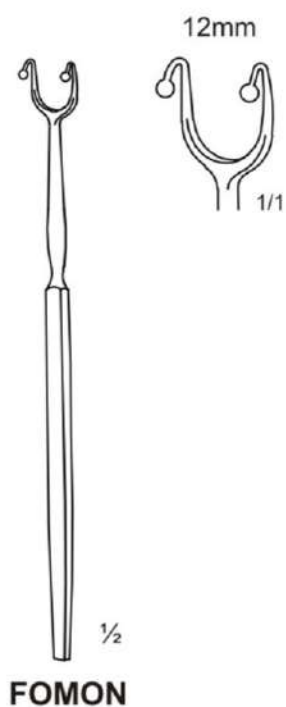

17-2500 | 16.0cm

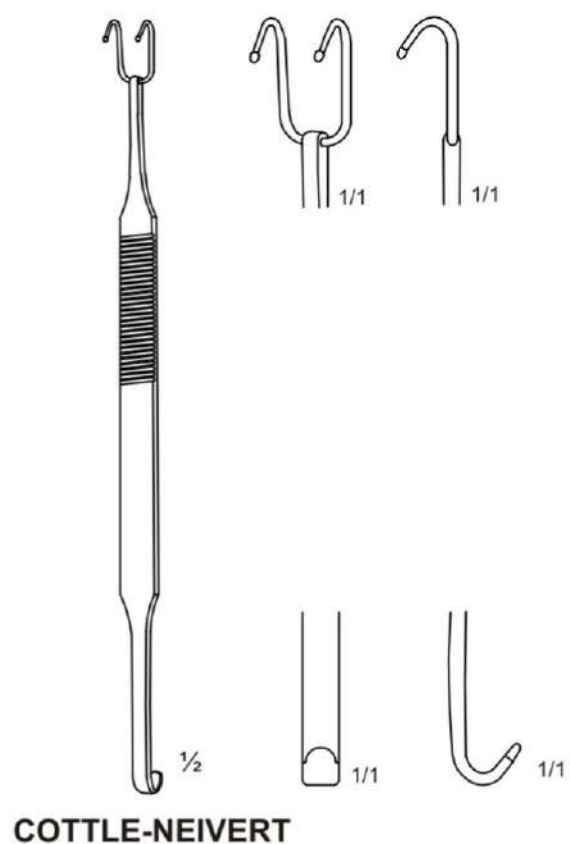

▶ 17-2600 | 19.5cm

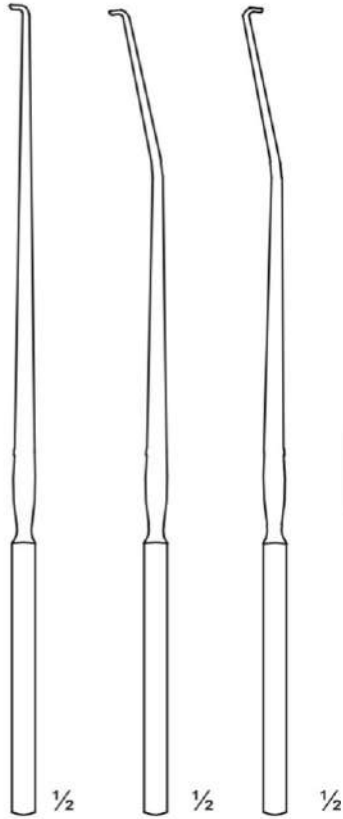

### DANDY

- ▶ 17-2701 Straight
- ▶ 17-2702 Left
- ▶ 17-2703 Right



### ADSON

- ▶ 17-2801 Sharp
- ▶ 17-2802 Blunt

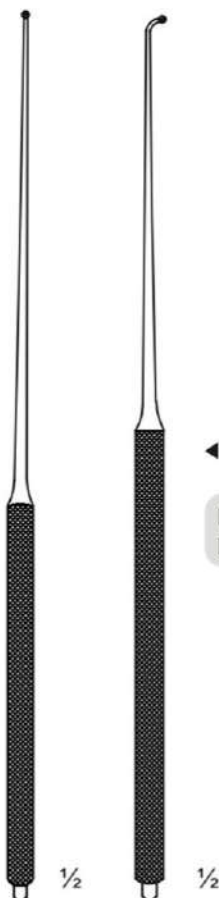

### ◀ BALL HOOK

- ▶ 17-3001 22.0cm Straight
- ▶ 17-3011 21.0cm Curved

### BALL HOOK ▶

- ▶ 17-3101 Curved, Short
- ▶ 17-3102 Curved, Long

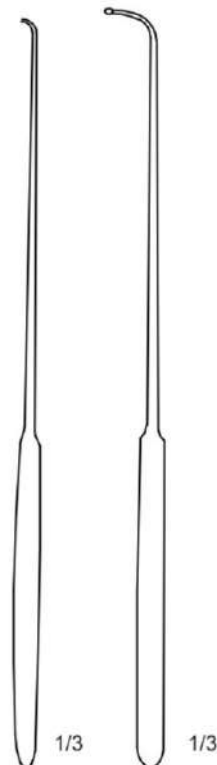



**YASARGIL**

Ligature Guides,  
Probe pointed

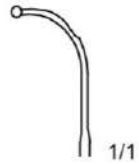

17-3201 | 18.5cm



17-3202 | 18.5cm

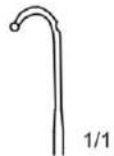

17-3203 | 18.5cm



17-3204 | 18.5cm

**KRAYENBUHL**

Nerve-and Vessel  
Hooks



17-3301 | 18.5cm



17-3302 | 18.5cm



17-3401 | 18.5cm



17-3402 | 18.5cm



1/2



1/1

17-3501	24.5cm	Insulated
17-3601	24.5cm	Not Insulated



1/1

17-3502	24.5cm	Insulated
17-3602	24.5cm	Not Insulated



1/1

17-3503	24.5cm	Insulated
17-3603	24.5cm	Not Insulated



1/1

17-3504	24.5cm	Insulated
17-3604	24.5cm	Not Insulated



1/2

**CASPAR**

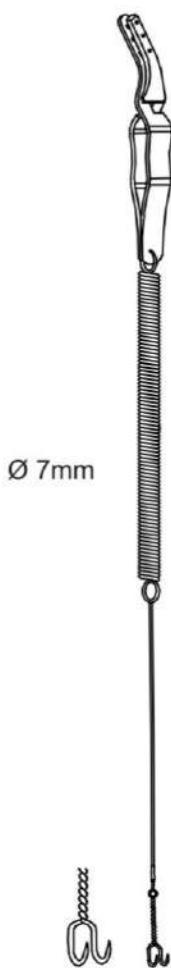
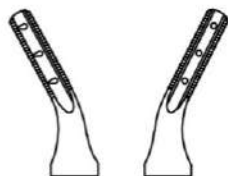
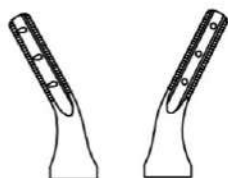

Ø 7mm

**YASARGIL GALEA**

17-3701



Ø 9mm

**YASARGIL GALEA**

▶ 17-3702



**SMITHWICK**

17-3801 30.0cm

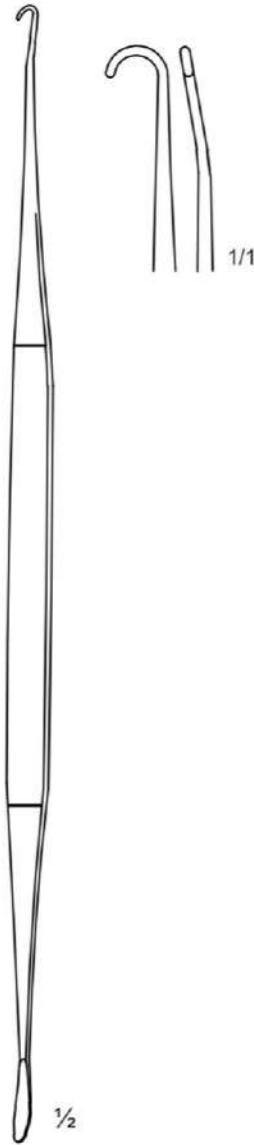

**SCOVILLE**

17-3802 30.0cm

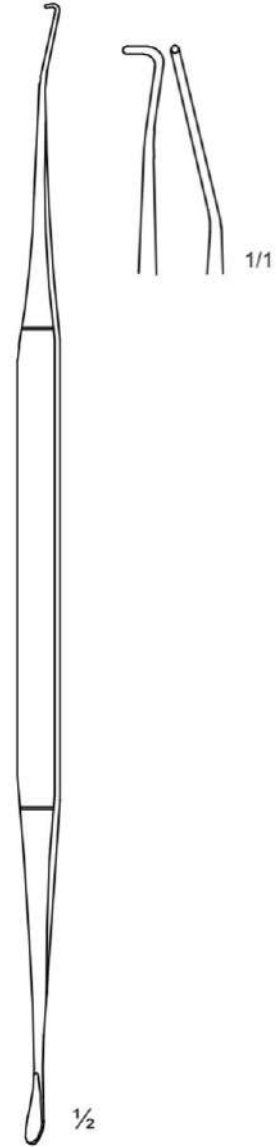

**SCOVILLE**

17-3803 30.0cm



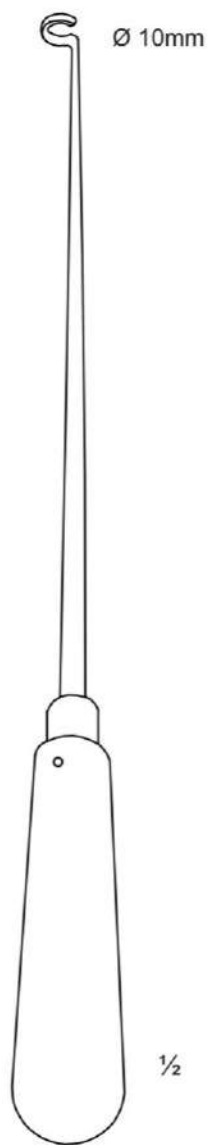

**VEIN**

▶ 17-3900 30.0cm

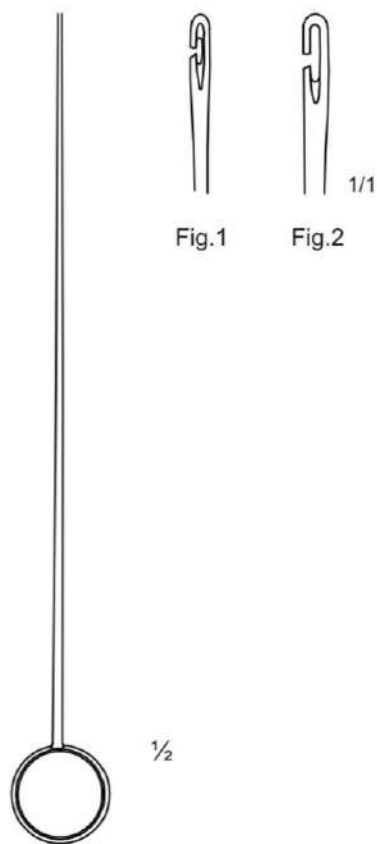

**TOURNIQUET**

▶ 17-4001 22.0cm Fig.1  
▶ 17-4002 22.0cm Fig.2





**Knife Handles**  
Knife Handles



**Dermatology**  
Dermatology



**Forceps Holders**  
Forceps Holders



1/2

# 3

▶ 18-0103 | 12.0cm



1/2

# 4

▶ 18-0104 | 13.0cm



1/2

# 7

▶ 18-0107 | 16.0cm



1/2

# 3 Long

▶ 18-0103L | 21.0cm



1/2

# 3 Long  
Curved

▶ 18-0113L | 20.5cm

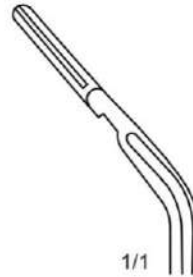

1/1



1/2

# 4 Long

▶ 18-0104L | 21.0cm

# Scalpel Handles



1/2

For Micro Surgery



1/1

Fig.1



1/1

Fig.2



1/1

Fig.3



1/1

Fig.4

18-0201	13.5cm	Fig.1
18-0202	15.5cm	Fig.2
18-0203	18.0cm	Fig.3
18-0204	20.0cm	Fig.4

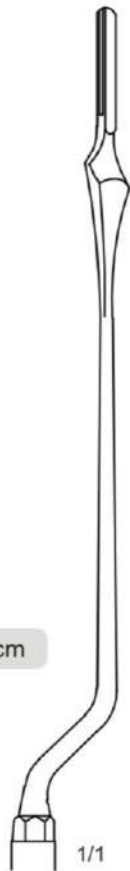

1/1

18-0300 21.0cm



18-0205 21.0cm  
18-0206 25.0cm

LANDOLT



1/2

For Micro Surgery



**LISTON**

18-0401	13.0cm
18-0402	16.0cm
18-0403	19.0cm
▶ 18-0404	21.5cm



**TAYLOR MOD.USA**

▶ 19-0100 | 20.0cm

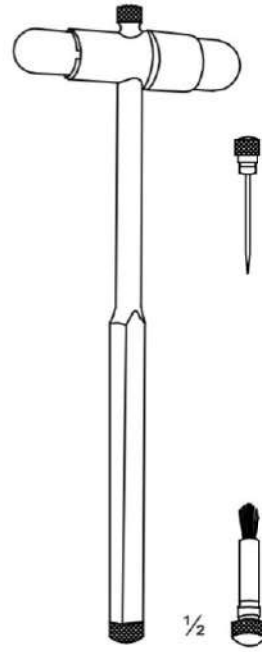

**BUCK**

▶ 19-0200 | 18.0cm

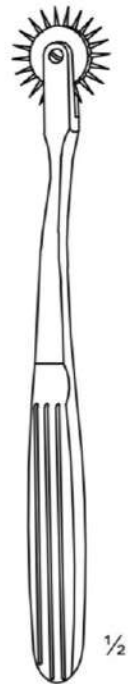

**WARTENBERG**

Pin Wheel

▶ 19-0300 | 19.0cm



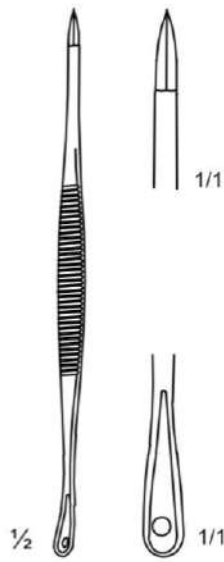

**SAALFELD**

Comedo Extractor

▶ 19-0400 14.0cm

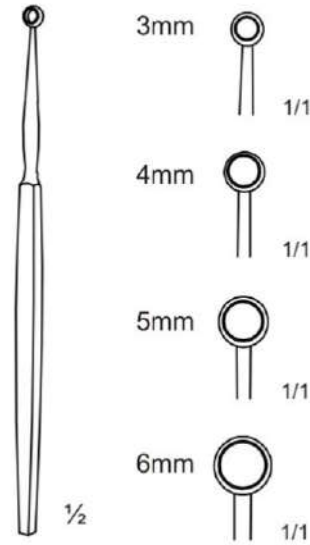

**FOX**

Lupus Curettes

▶ 19-0503 3mm  
▶ 19-0504 4mm  
▶ 19-0505 5mm  
▶ 19-0506 6mm



**KEYES**

Dermal Punches

▶ 19-0702 2mm  
▶ 19-0703 3mm  
▶ 19-0704 4mm  
▶ 19-0705 5mm  
▶ 19-0706 6mm  
▶ 19-0707 7mm  
▶ 19-0708 8mm

- 2mm ○
- 3mm ○
- 4mm ○
- 5mm ○
- 6mm ○
- 7mm ○
- 8mm ○ 1/1

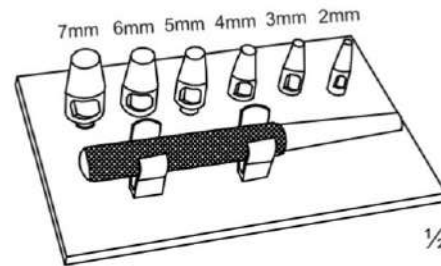

**KEYES**

Dermal Punch set, complete, with 6 Interchangeable tips, handle and rack

▶ 19-0800 19.0cm

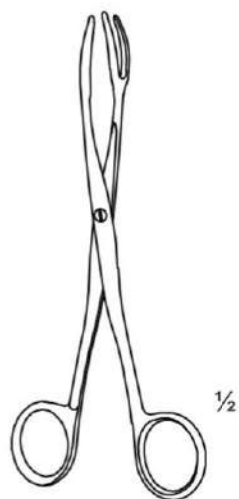

- ▶ 20-0101 20.0cm
- ▶ 20-0102 30.0cm

**STERILIZING**

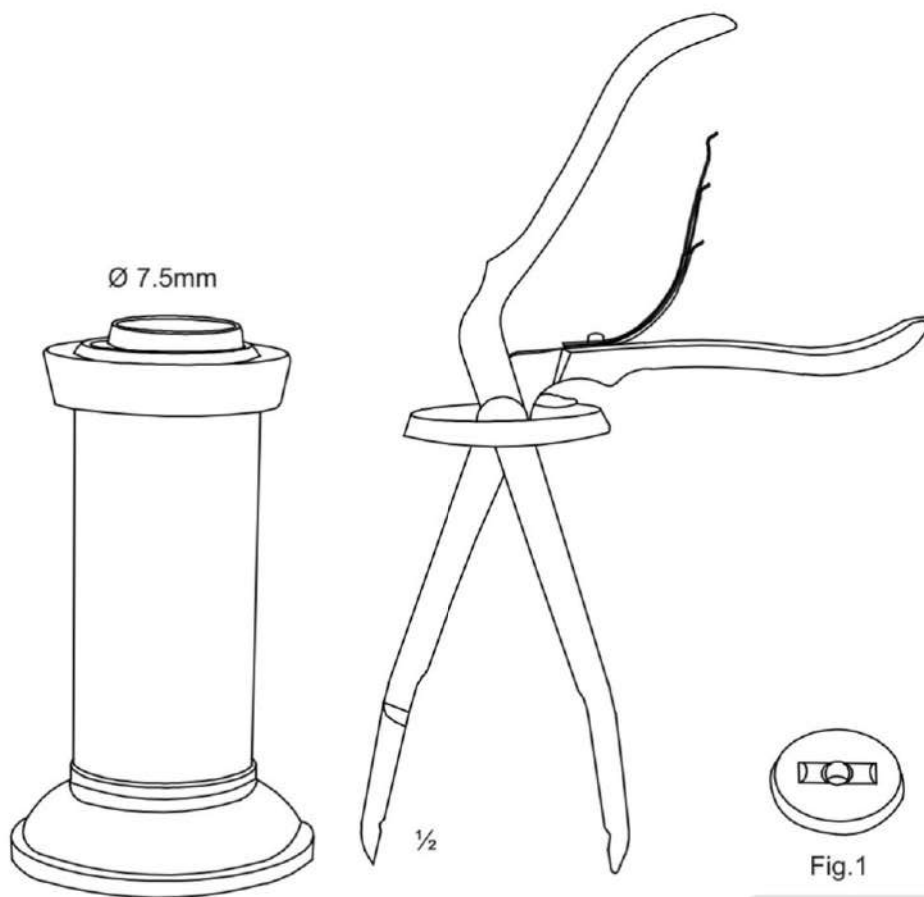

**TRANS FORCEPS JAR SET**

- ▶ 20-0200

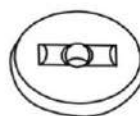

Fig.1

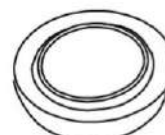
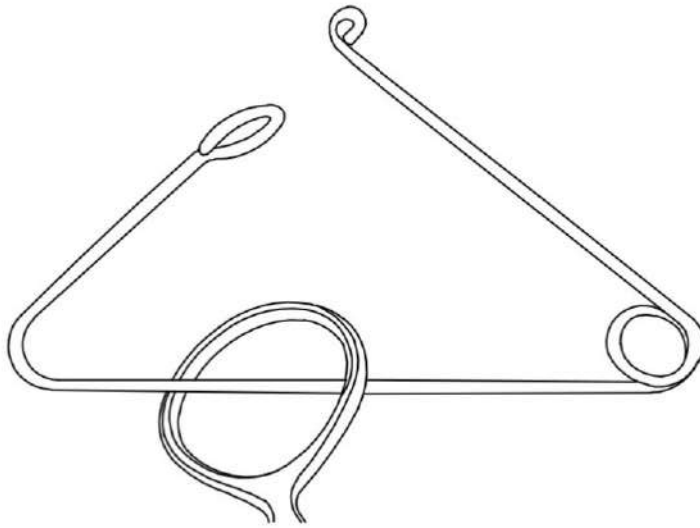

Fig.2

- ▶ 20-0201 Silicon Fig.1
- ▶ 20-0102 Silicon Fig.2



**BUNT**  
Forceps Holder

▶ 20-0300

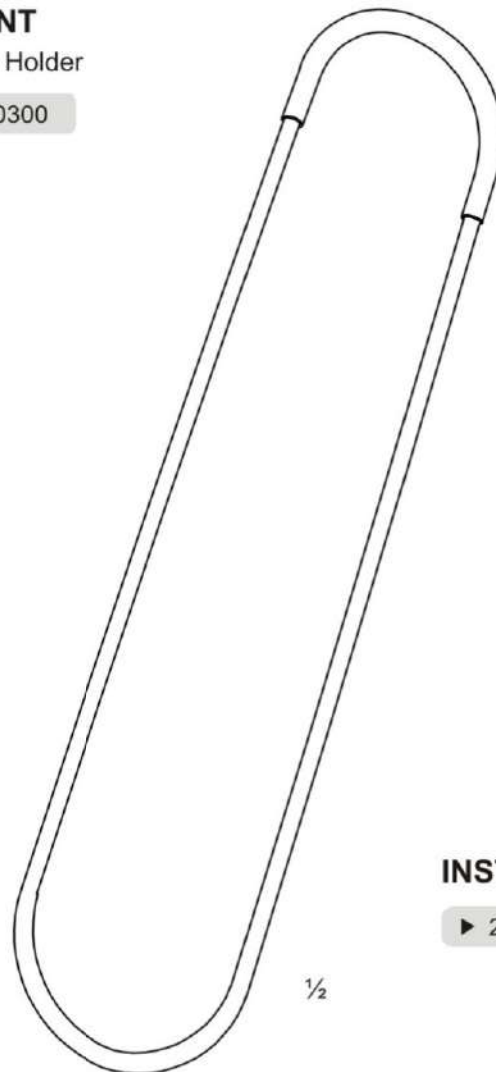

**INSTRUMENT** Sterilizing Rack

▶ 20-0400 8.5x30.8cm

1/2



# Rectal Surgery

Rectal Surgery



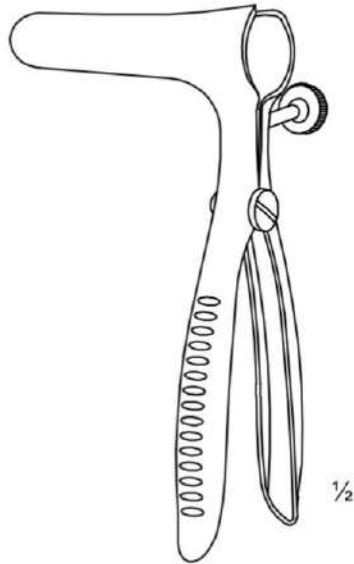

**SIMS**

► 21-0101 15.0cm 75 x 17mm

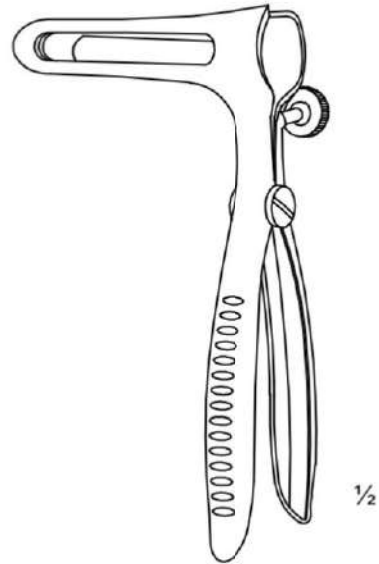

**SIMS**

21-0102 15.0cm 75 x 17mm

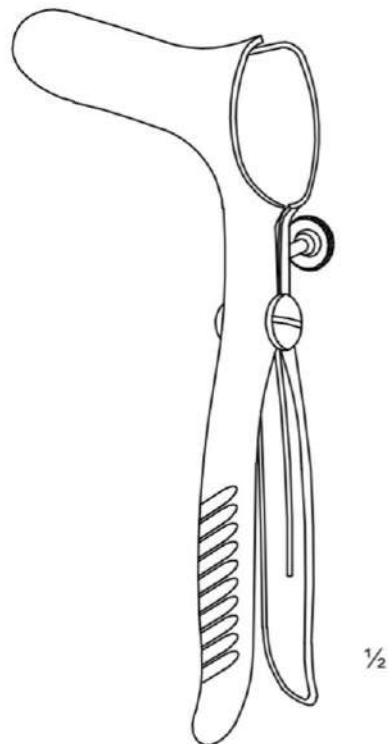

**PRATT**

21-0200 20.5cm 80 x 25mm

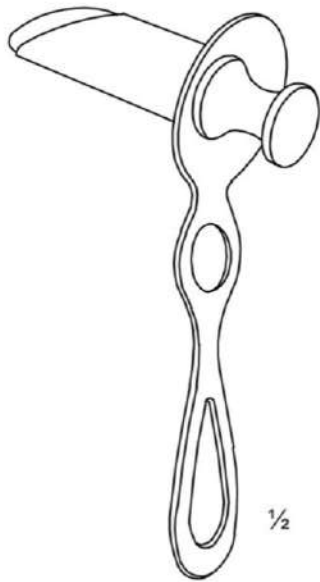

1/2

**HIRSCHMANN**  
Anoscope

▶ 21-0301	16 x 65mm
▶ 21-0302	19 x 65mm
21-0303	22 x 65mm

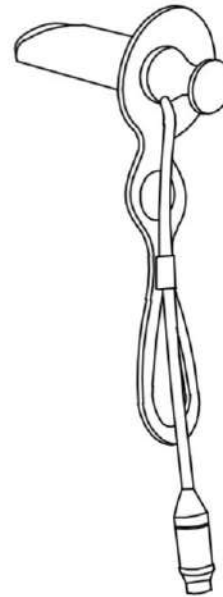

1/2

**HIRSCHMANN**  
With F/O illumination

21-0311	16 x 65mm
21-0312	19 x 65mm
21-0313	22 x 65mm

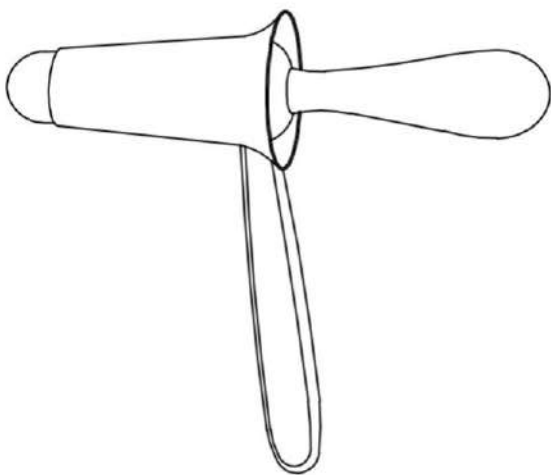

**KELLY**

21-0321	5.0cm	o 21mm
21-0322	5.0cm	o 25mm

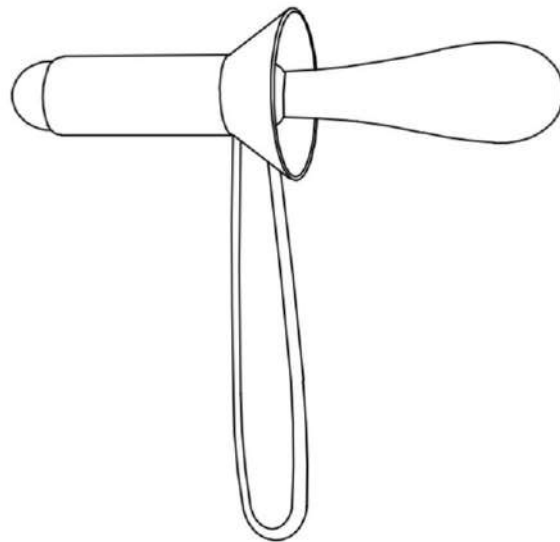

**KELLY**

21-0331	5.0cm	o 22mm
21-0332	10.0cm	o 22mm
21-0333	14.5cm	o 22mm
21-0334	20.0cm	o 22mm

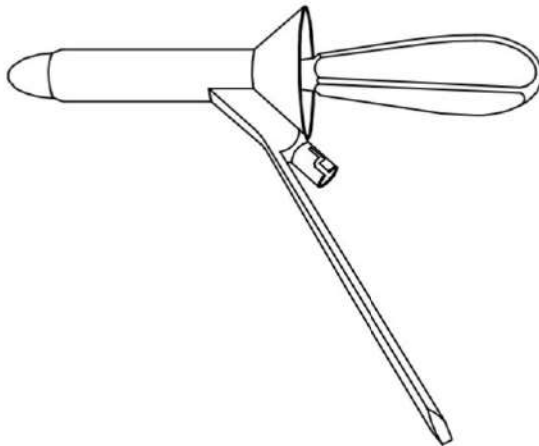

**MORGAN**

21-0401	6.5cm	ø 17mm
21-0402	8.0cm	ø 17mm
21-0403	6.5cm	ø 20mm
21-0404	8.0cm	ø 20mm
21-0405	6.5cm	ø 24mm
21-0406	8.0cm	ø 24mm

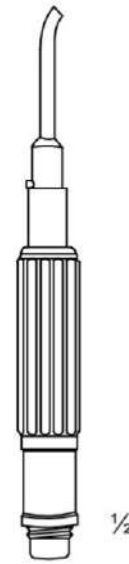

21-0420

With F/O illumination with Combi-Connection

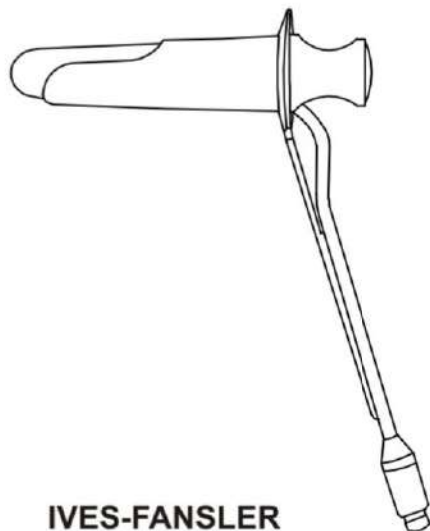

**IVES-FANSLER**

Proctoscope with F/O illumination

21-0410 8.0cm ø 22mm

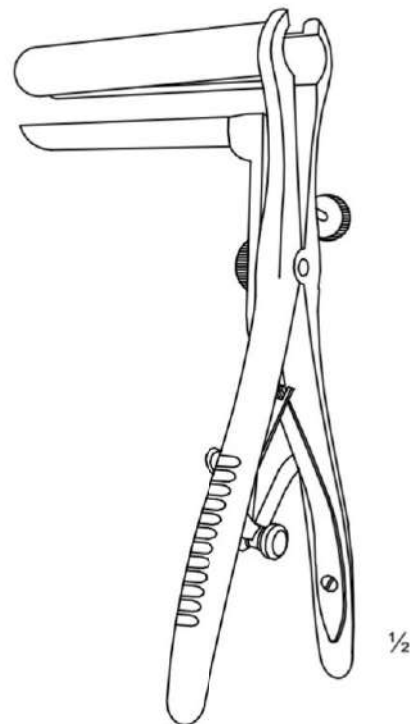

**MATHIEU**

21-0400 19.5cm 90 x 15mm



**Rectal Retractors**

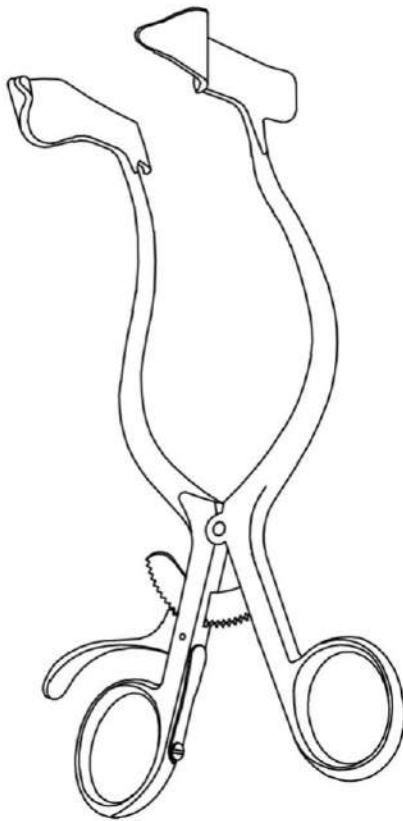

1/2

**SUMIKOSHI'S**

▶ 21-0500 19.0cm

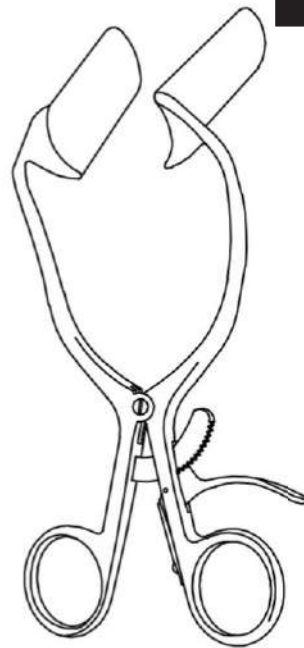

1/2

**BARR**

▶ 21-0600 17.0cm 70 x 22mm

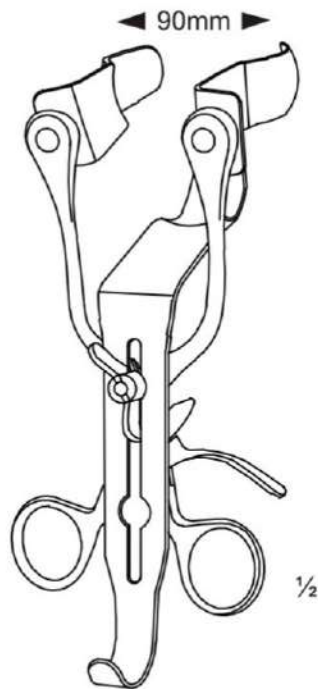

1/2

**PARKS SET**

- Spreader only
- Center blade only
- 1 Pair of blades only, 70mm deep
- 1 Pair of blades only, 93mm deep

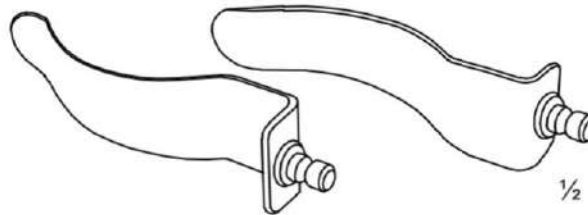

1/2

21-0700	Set	
21-0701	Spreader	14.0cm
21-0711	Center blade	95mm deep
21-0721	blade	70mm deep
21-0722	blade	93mm deep
21-0723	blade	90mm deep
21-0724	blade	150mm deep

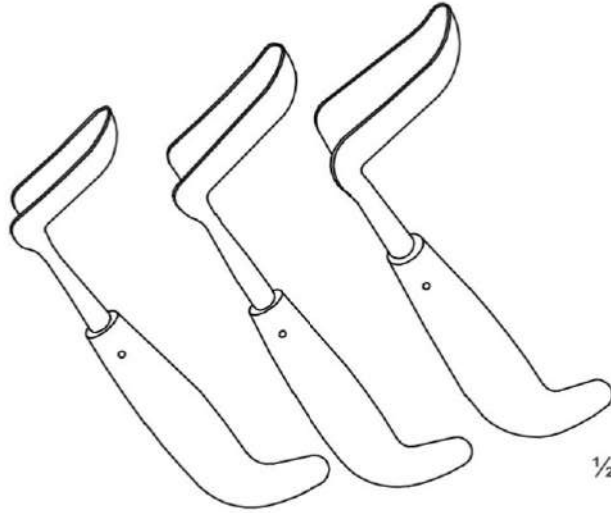

- ▶ 21-0901 Small
- ▶ 21-0902 Medium
- ▶ 21-0903 Large

**FERGUSON**  
Rectal Retractors

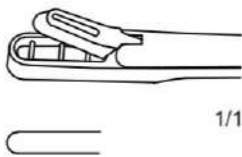

21-1001	28.0cm
21-1002	35.0cm
21-1003	42.0cm

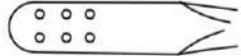
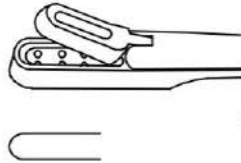

21-1101	28.0cm
21-1102	35.0cm
21-1103	42.0cm

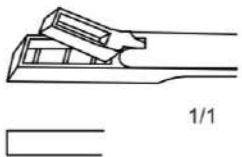

21-1201	28.0cm
21-1202	35.0cm
21-1203	42.0cm

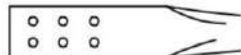
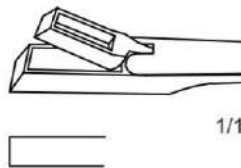

21-1301	28.0cm
21-1302	35.0cm
21-1303	42.0cm

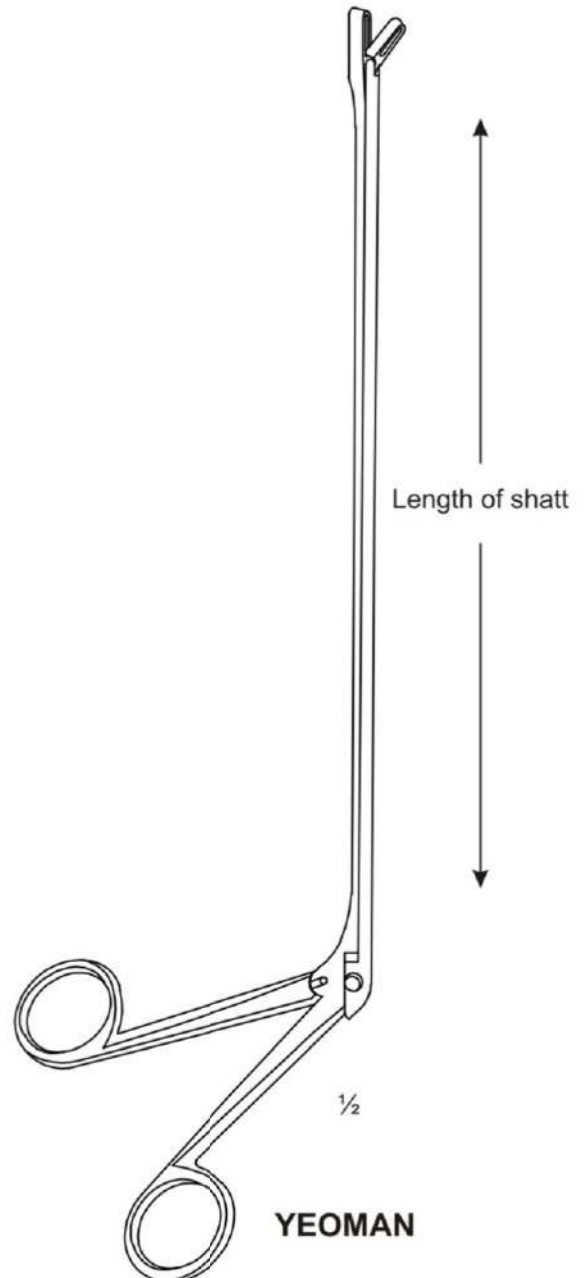

**YEOMAN**

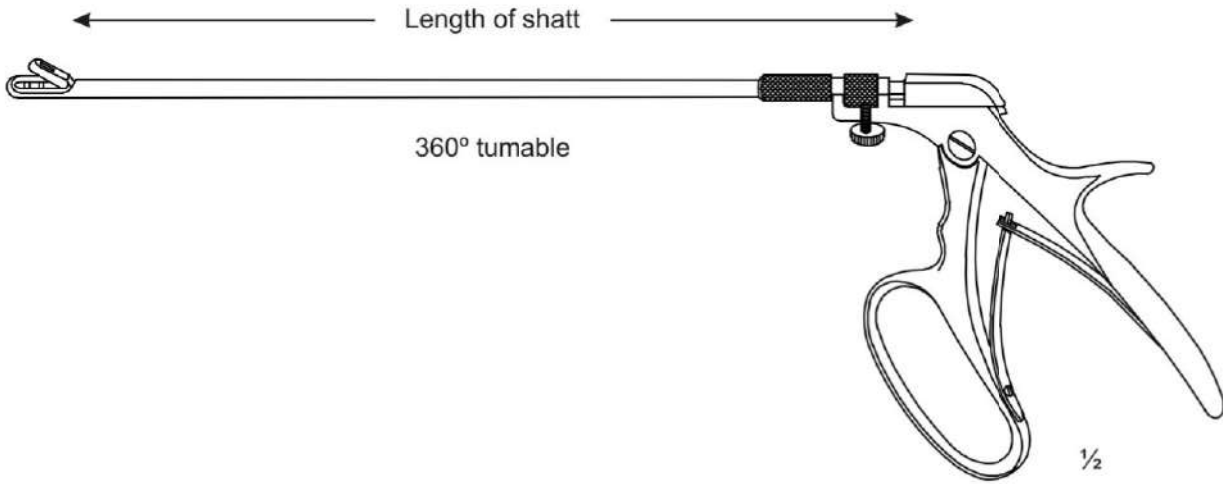

**YEOMAN**

21-1401	28.0cm
21-1402	35.0cm
21-1403	40.0cm

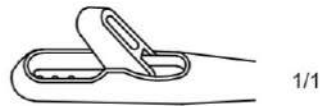

**YEOMAN**

21-1501	28.0cm
21-1502	35.0cm
21-1503	40.0cm

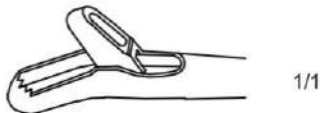

**TURREL**

21-1601	28.0cm
21-1602	35.0cm
21-1603	40.0cm

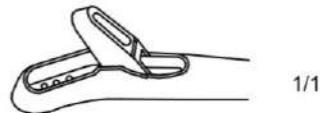

**TURREL**

21-1701	28.0cm
21-1702	35.0cm
21-1703	40.0cm

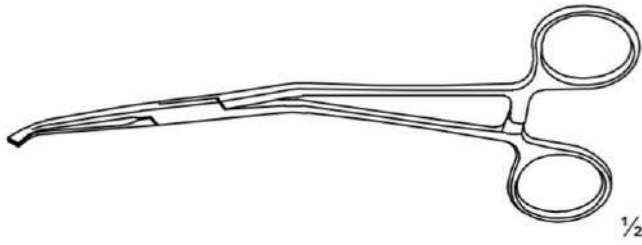

**MC GIVNEY**  
Haemorrhoidal Forceps

21-1800 18.5cm 75 x 17mm



**O-RINGS**

Ligature rubber rings, in package of 100pieces

21-1900



**RUDD**

21-2001	27.0cm	∅ 12mm
21-2011	Loading cone only	∅ 12mm

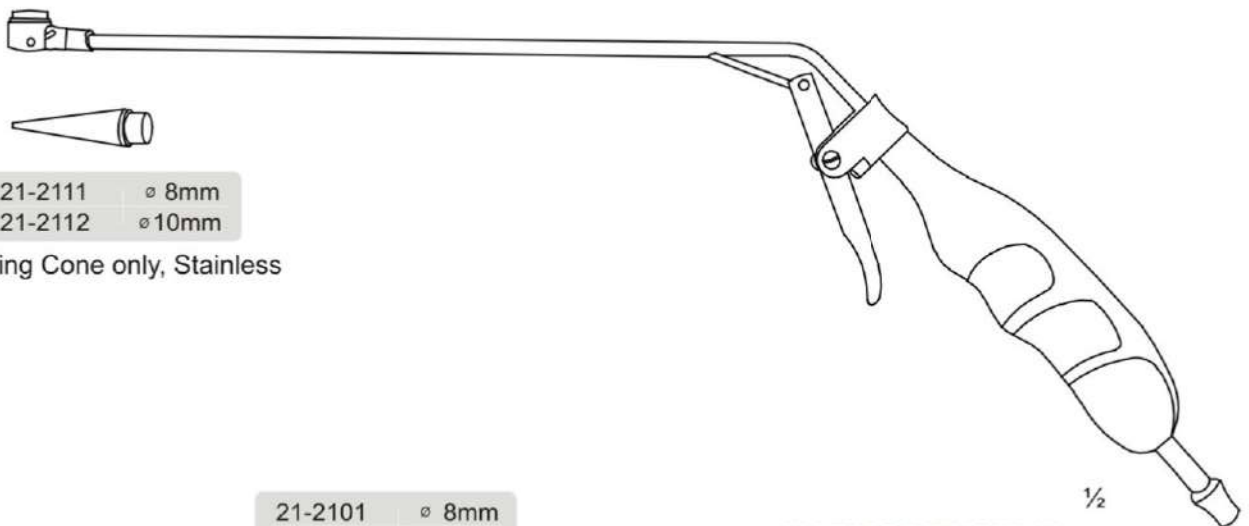

21-2111	∅ 8mm
21-2112	∅ 10mm

Loading Cone only, Stainless

21-2101	∅ 8mm
21-2102	∅ 10mm

**HAEMORRHOIDAL**

Haemorrhoidal Suction Ligator complete, stainless, 90 angled, with Loading Cone and suction unit connection

# Haemorrhoidal Ligators

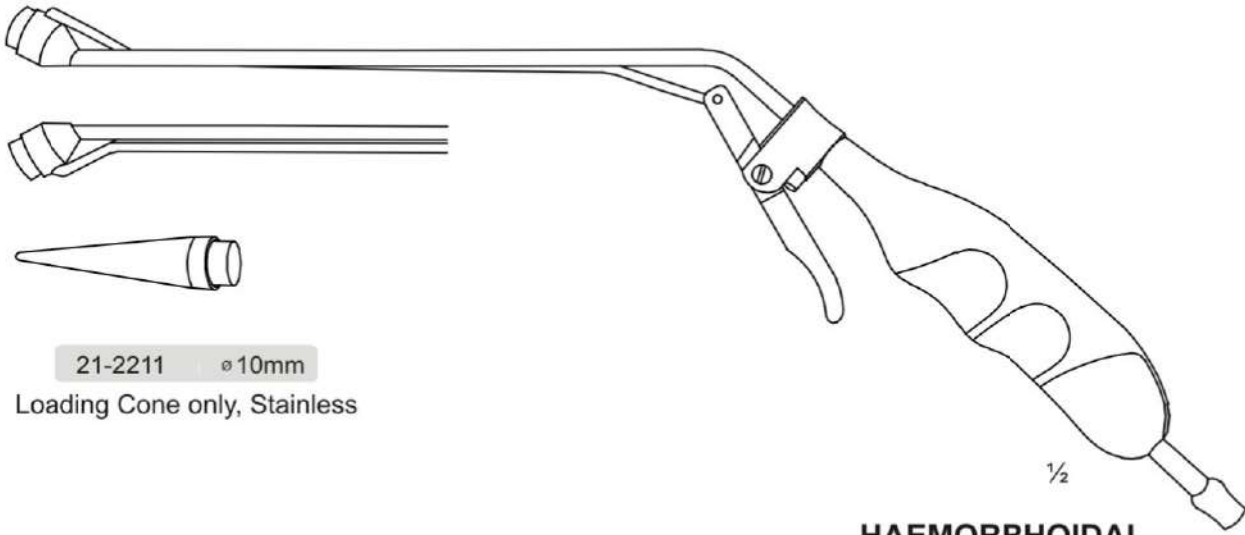

21-2211    ø 10mm

Loading Cone only, Stainless

**HAEMORRHOIDAL**

- 21-2201    Suction head angled up
- 21-2202    Suction head angled down

Haemorrhoidal Suction Ligator complete, stainless, 30 angled, with Loading Cone and suction stop connectable to suction unit

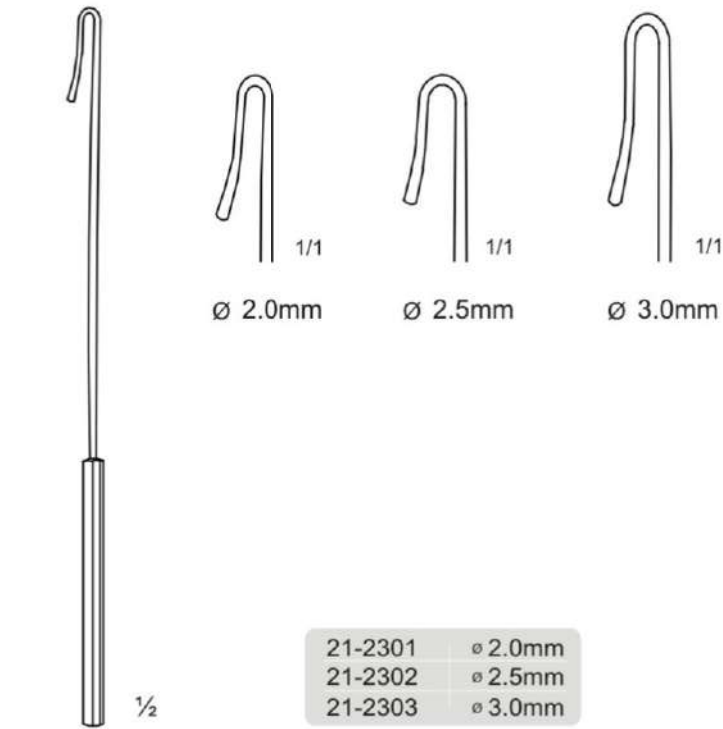

- 21-2301    ø 2.0mm
- 21-2302    ø 2.5mm
- 21-2303    ø 3.0mm

**PRATT**  
Fistula Probes

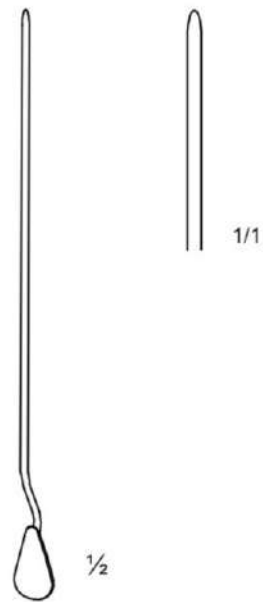

**LOCKHART-MUMMERY**

▶ 21-2401 | 16.5cm | Straight

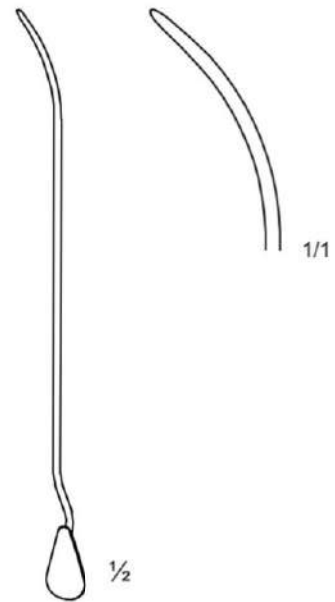

**LOCKHART-MUMMERY**

▶ 21-2402 | 16.5cm | 45°

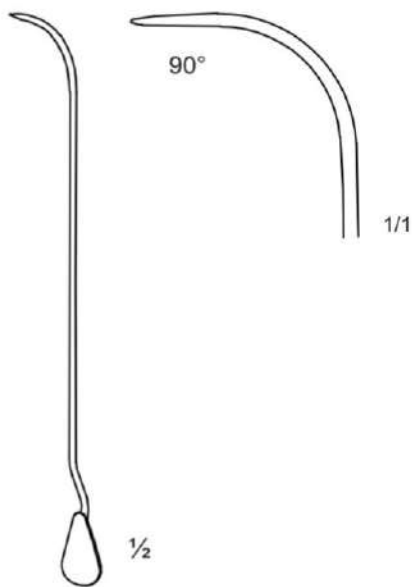

**LOCKHART-MUMMERY**

▶ 21-2403 | 16.5cm

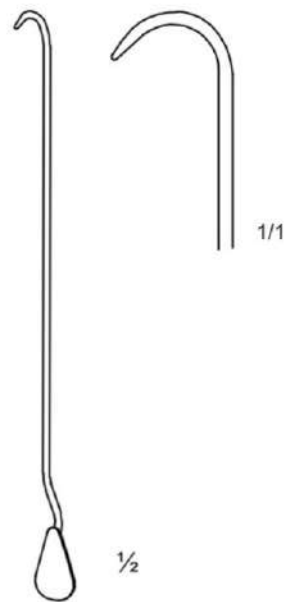

**LOCKHART-MUMMERY**

▶ 21-2404 | 16.5cm | Curved



**LARRY  
probe**

▶ 21-2500 | 15.0cm



## **Sponge Holding Forceps**

Sponge Holding Forceps

- *Towel Clips*
- *Sponge Holding Forceps*
- *Catheter Forceps etc.*



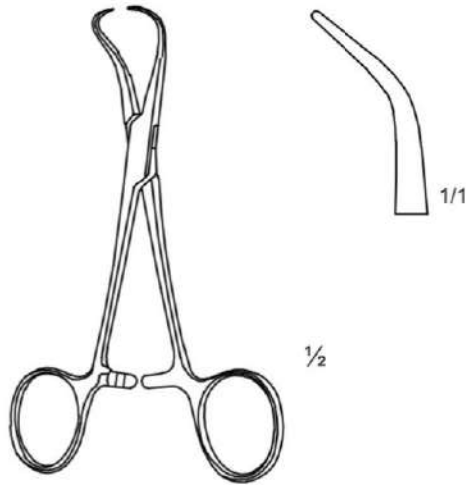

**BACKHAUS**

▶ 22-0101	8.0cm
▶ 22-0102	11.0cm
▶ 22-0103	13.0cm
22-0104	15.0cm

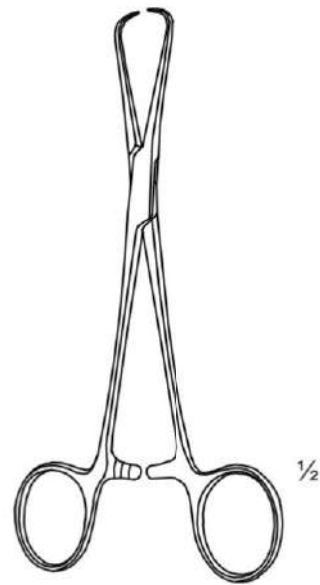

**BERNHARD**

22-0200	16.5cm
---------	--------

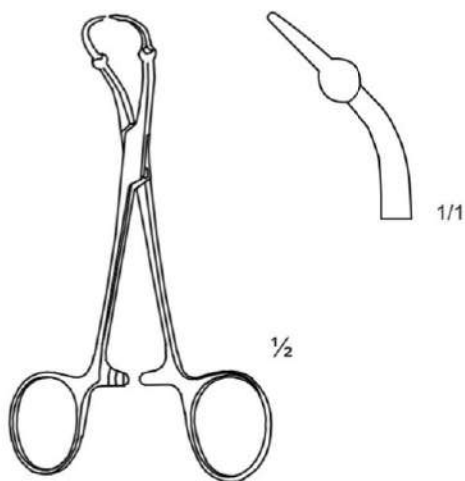

**ROEDER**  
with Ball stop

▶ 22-0301	13.0cm
22-0302	15.0cm

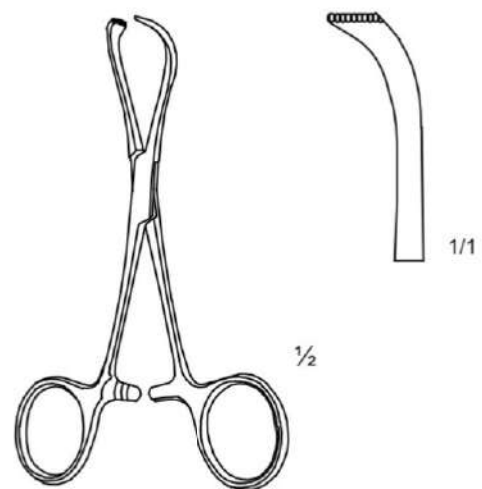

**LORNA**

22-0401	10.0cm
▶ 22-0402	13.0cm

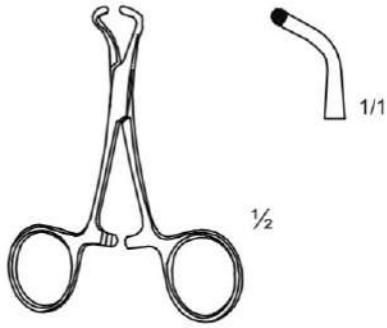

**TOHOKU**

▶ 22-0501	10.5cm
22-0502	13.5cm

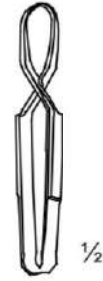

**SCHADEL**

22-0600	9.0cm
---------	-------

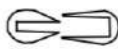

**DOYEN**

22-0700	18.0cm
---------	--------

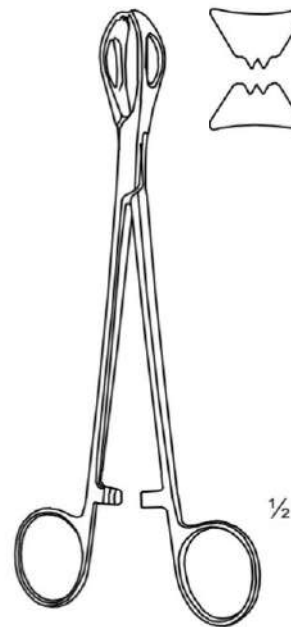
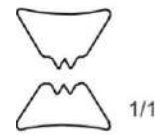

**LANE**

22-0801	15.0cm
22-0802	20.0cm

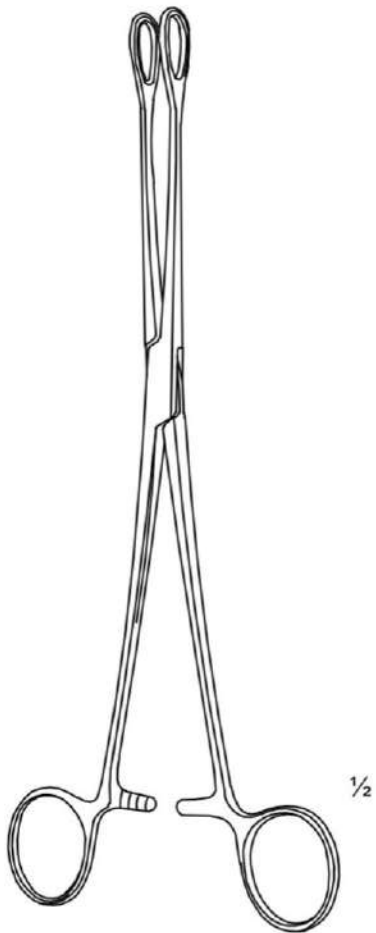

**FOERSTER-BALLENGER**

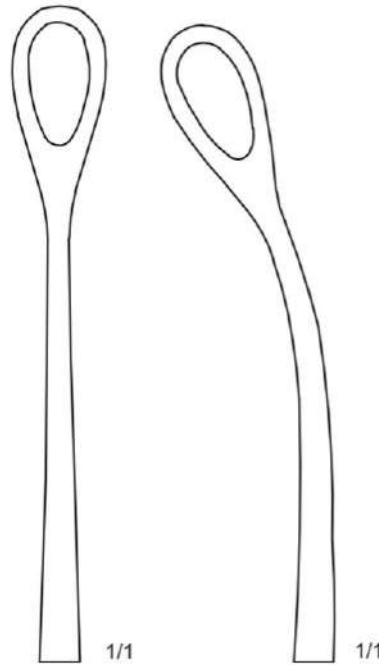

smooth jaws

smooth jaws

▶ 23-0101	18.0cm	Straight
▶ 23-0102	20.0cm	Straight
▶ 23-0103	25.0cm	Straight

▶ 23-0111	18.0cm	Curved
▶ 23-0112	20.0cm	Curved
▶ 23-0113	25.0cm	Curved

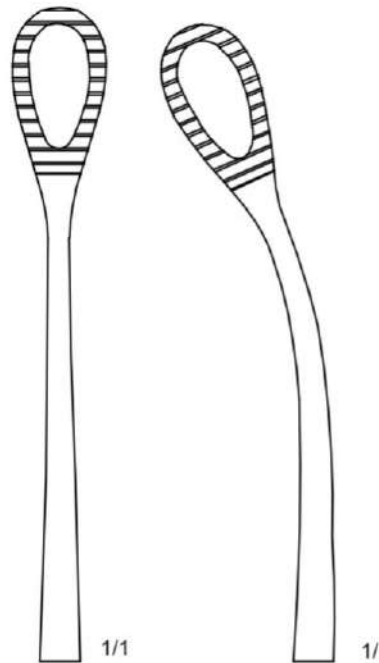

serrated jaws

serrated jaws

▶ 23-0201	18.0cm	Straight
▶ 23-0202	20.0cm	Straight
▶ 23-0203	25.0cm	Straight

▶ 23-0211	18.0cm	Curved
▶ 23-0212	20.0cm	Curved
▶ 23-0213	25.0cm	Curved

# Sponge & Dressing Forceps

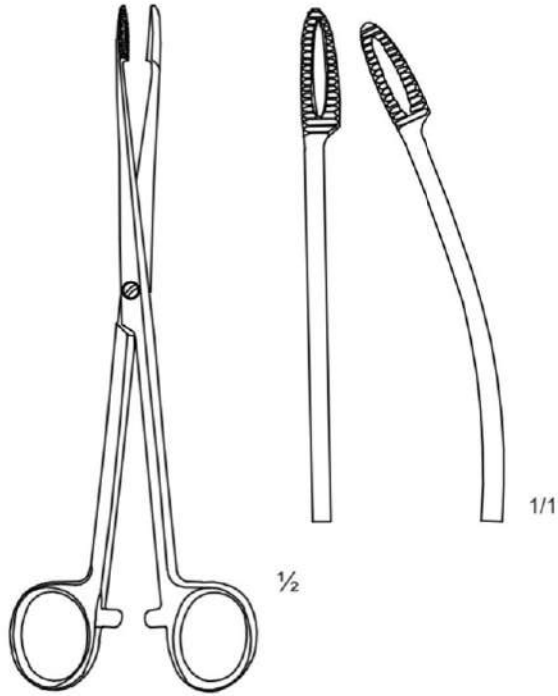

**GROSS**  
with ratchet

23-0301	14.5cm	Straight
23-0302	18.0cm	Straight
23-0303	20.0cm	Straight

23-0311	14.5cm	Curved
23-0312	18.0cm	Curved
23-0313	20.0cm	Curved

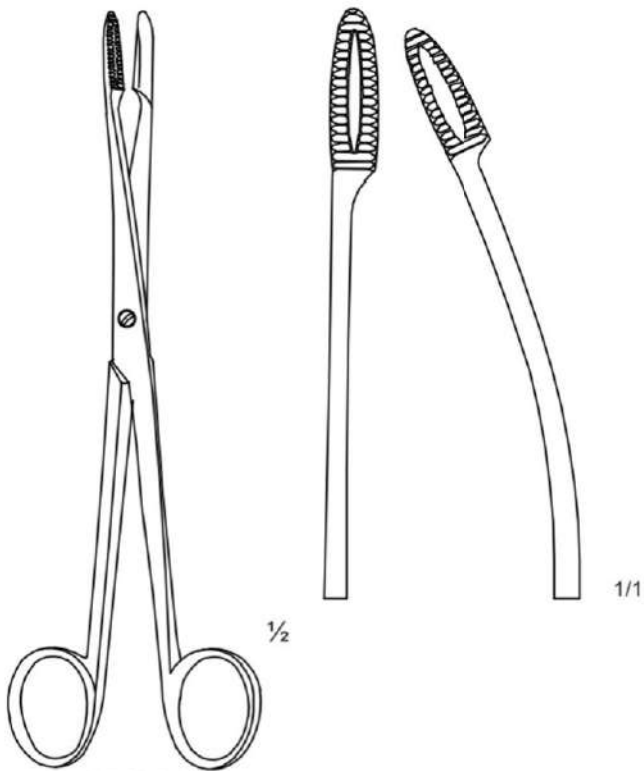

**GROSS**  
without ratchet

23-0401	14.5cm	Straight
23-0402	18.0cm	Straight
23-0403	20.0cm	Straight

23-0411	14.5cm	Curved
23-0412	18.0cm	Curved
23-0413	20.0cm	Curved

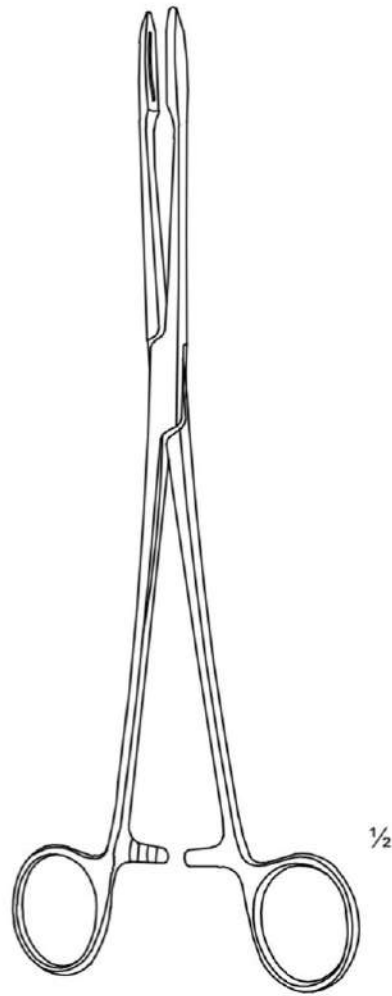

**GROSS-MAIER**

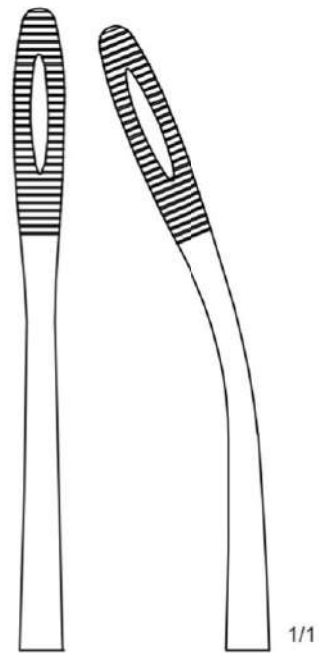

23-0501	20.0cm	Straight
23-0502	22.0cm	Straight
23-0503	25.0cm	Straight

23-0511	20.0cm	Curved
23-0512	22.0cm	Curved
23-0513	25.0cm	Curved

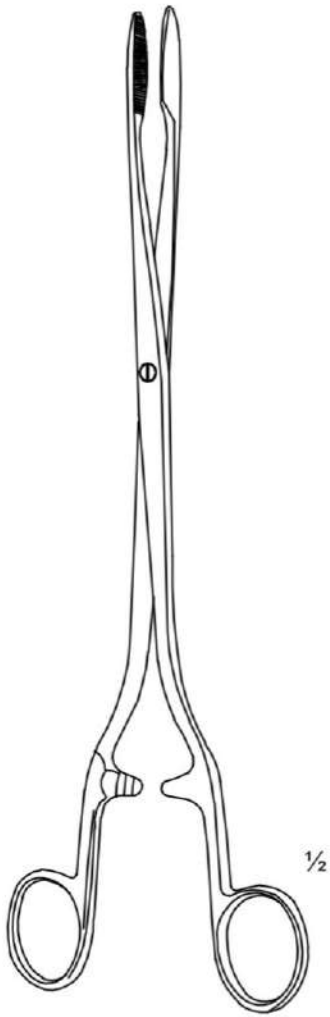

**SIMS-MAIER**

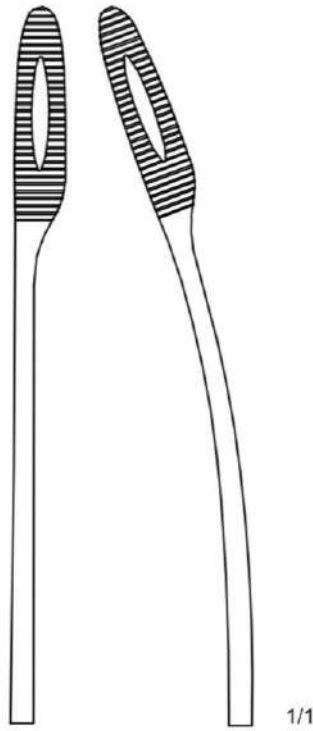

23-0601	28.0cm	Straight
23-0611	28.0cm	Curved

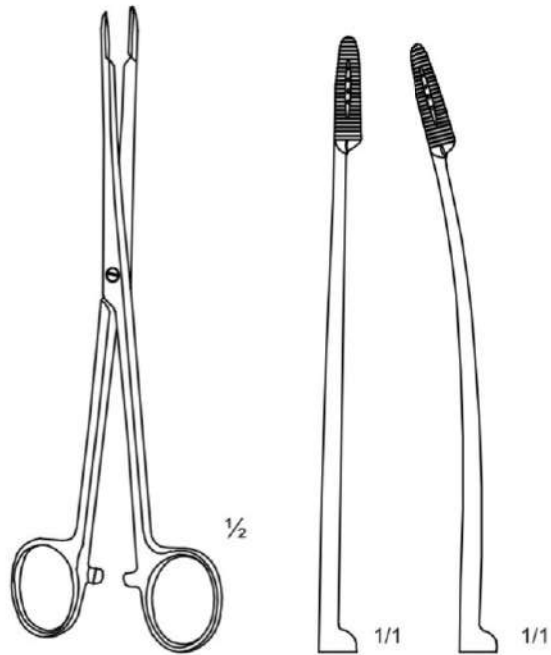

**WALTON**

23-0701	17.0cm	Straight
23-0711	17.0cm	Curved

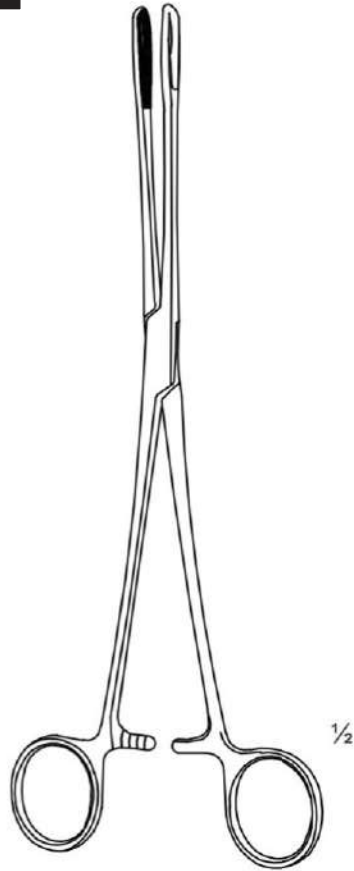

**RAMPLEY**

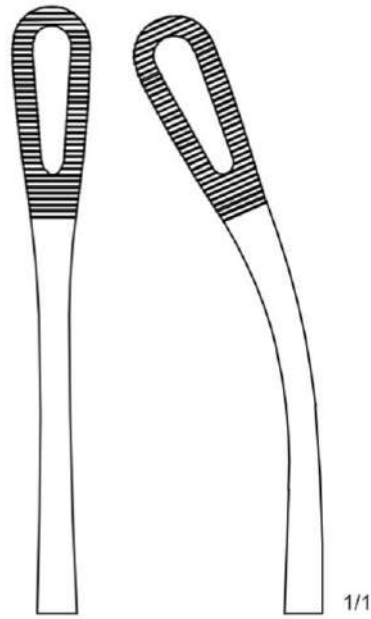

23-0801	25.0cm	Straight
23-0811	25.0cm	Curved

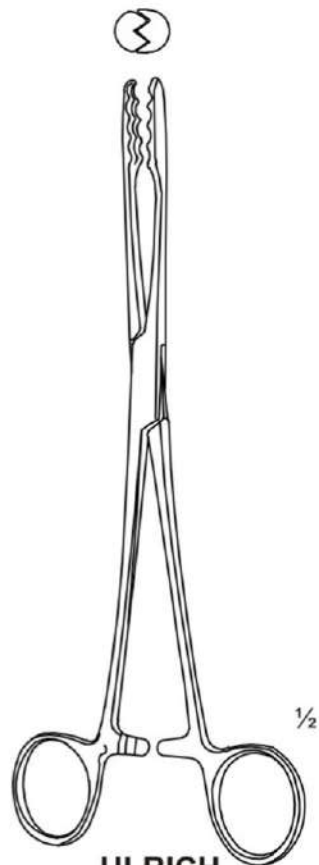

**ULRICH**

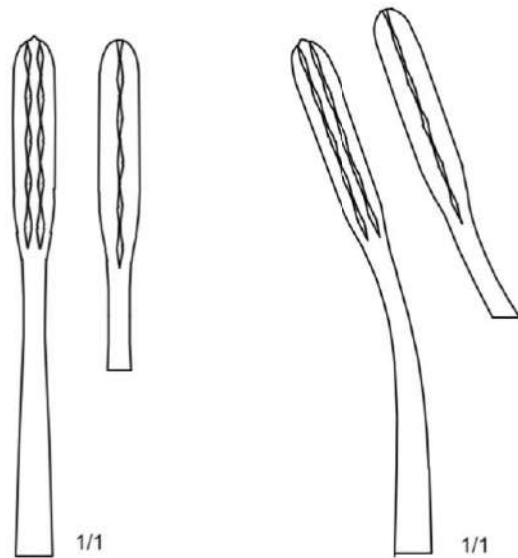

23-0901	22.0cm	Straight
23-0911	22.0cm	Curved



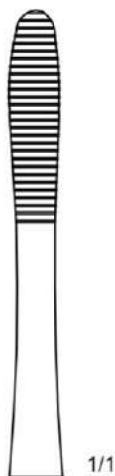
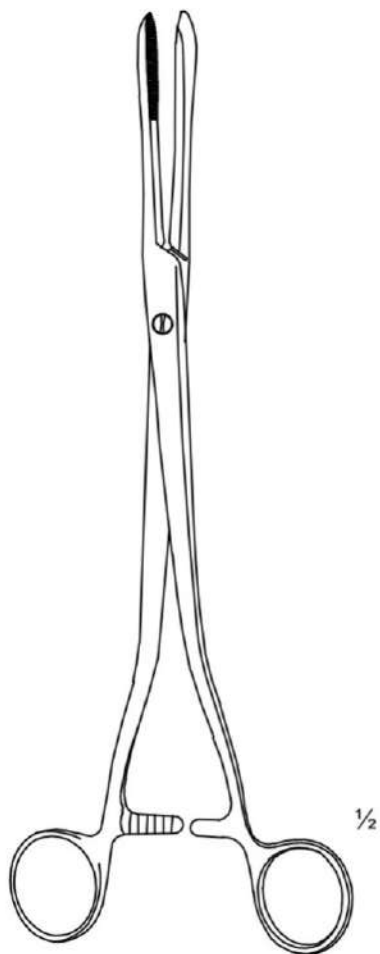

**COLLIN**

23-1001	25.0cm	Straight
23-1011	25.0cm	Curved

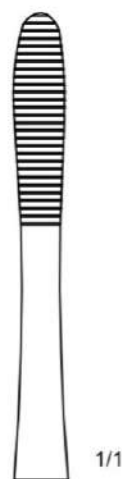
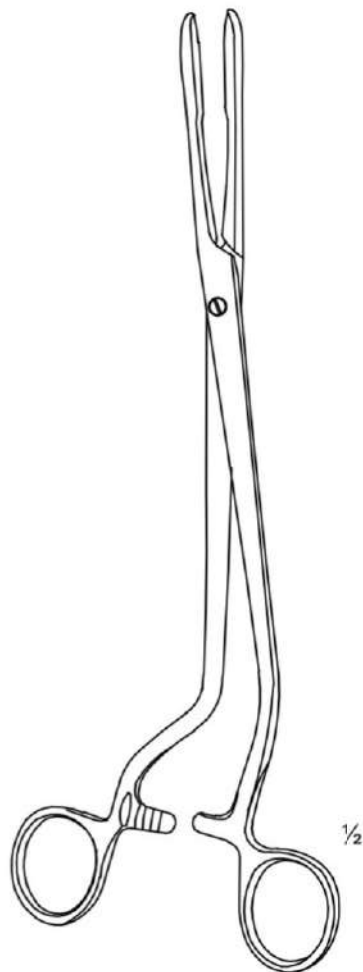

**CHERON**

23-1100	25.0cm
---------	--------

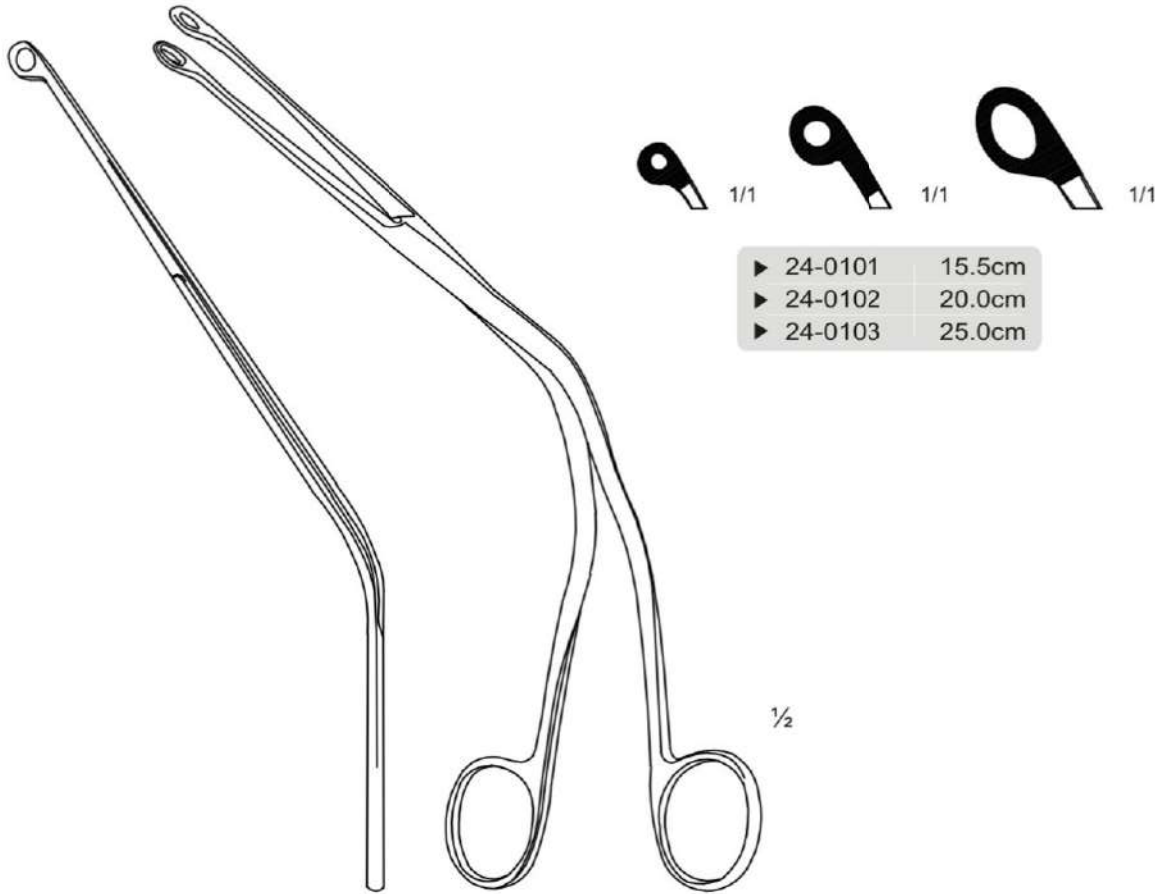

**MAGILL**  
Catheter Forceps

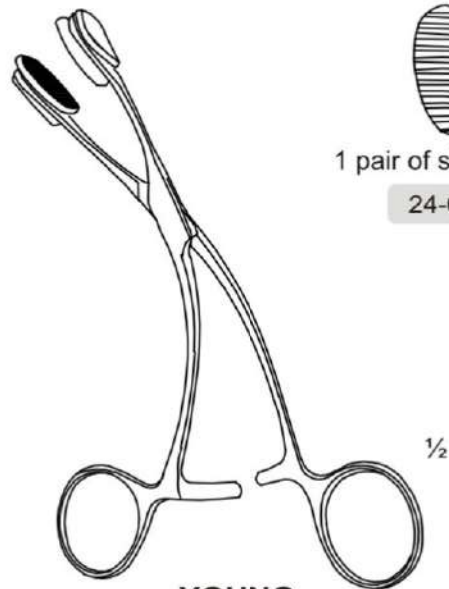

1 pair of silicon pads

24-0201

**YOUNG**  
Tongue Holding Forceps

▶ 24-0200 | 17.0cm



**Trocars**  
Trocars



**Suction Tubes**  
Suction Tubes



**OCHSNER**  
Trocar

- ▶ 25-0101    ∅ 4.5mm
- ▶ 25-0102    ∅ 5.5mm
- ▶ 25-0103    ∅ 6.5mm
- ▶ 25-0104    ∅ 7.5mm



**DOUGLAS**  
Trocar

25-0200    14.0cm

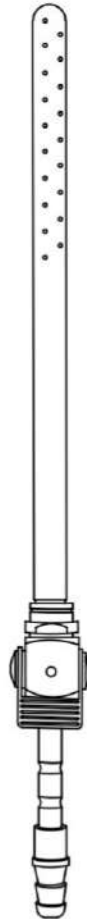

**SOLCO POOLE**  
▶ 26-0100    26.0cm



∅ 8mm

**POOLE**

- ▶ 26-0101    22.0cm    Straight
- ▶ 26-0111    22.0cm    Curved

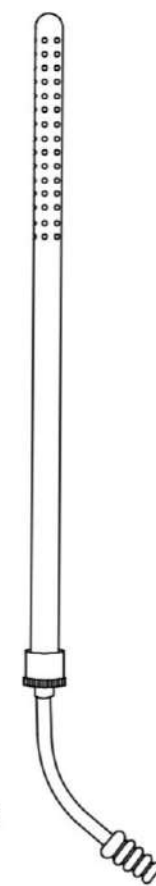

1/2

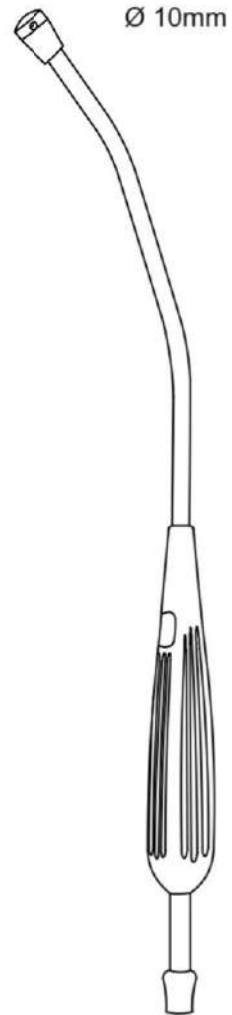

**YANKAUER**  
▶ 26-0200    28.0cm



Ø 8mm

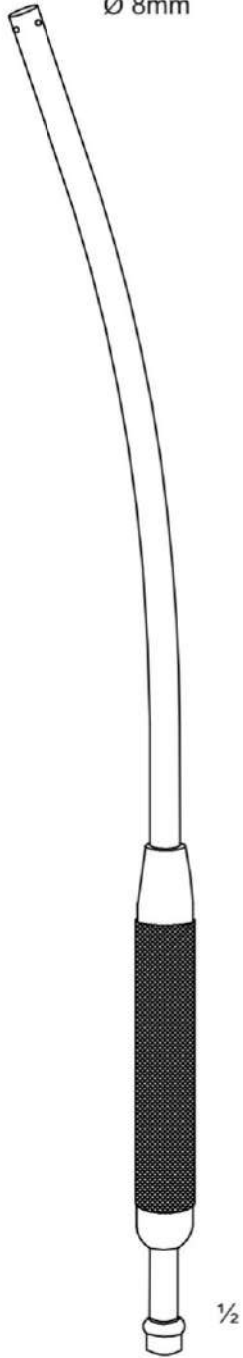

COOLEY

26-0301	35.0cm	ø 8mm
26-0302	31.0cm	ø 7mm

Ø 7mm

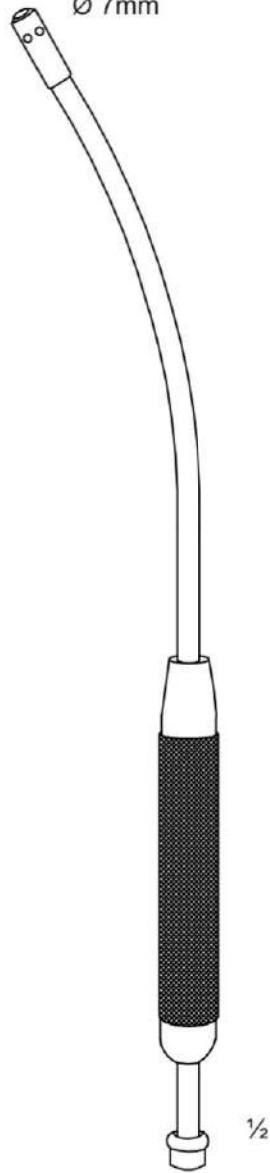

COOLEY

Ø 9mm

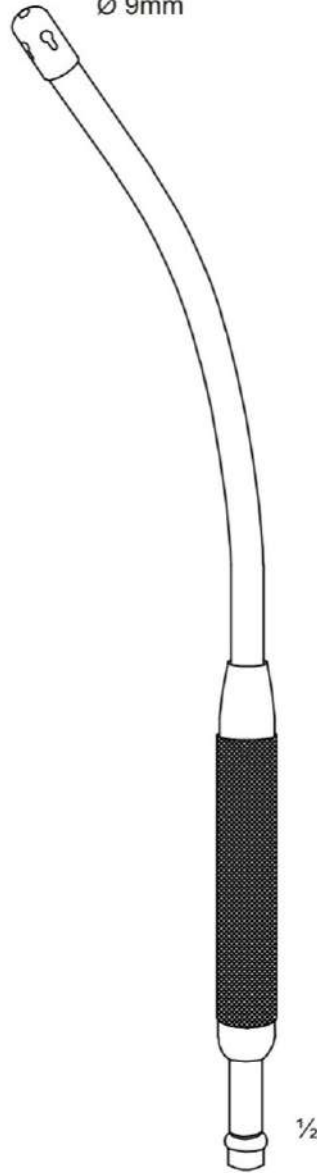

COOLEY

26-0303	31.0cm	ø 9mm
26-0304	35.0cm	ø 8mm

Ø 8mm

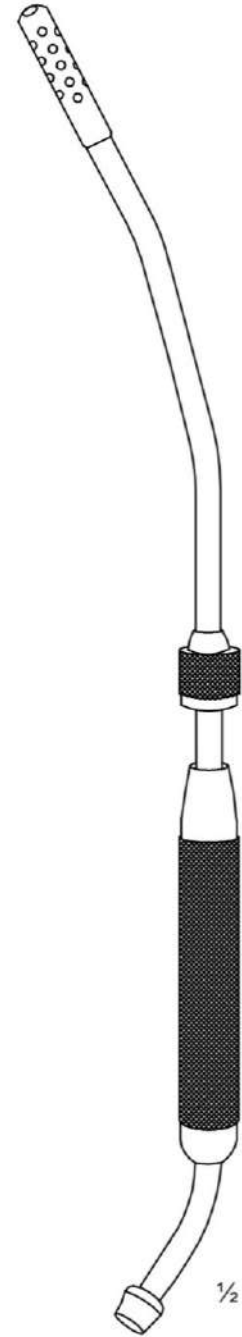

COOLEY





## Mouth Gags

### Mouth Gags

- Mouth Gags
- Tongue Depressure



## Vein Strippers

### Vein Strippers



## Probes

### Probes

- Probes
- Cotton Applicator



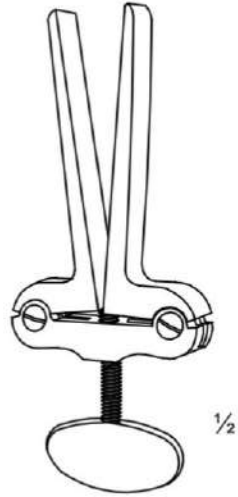

**HEISTER**

▶ 27-0100 13.0cm

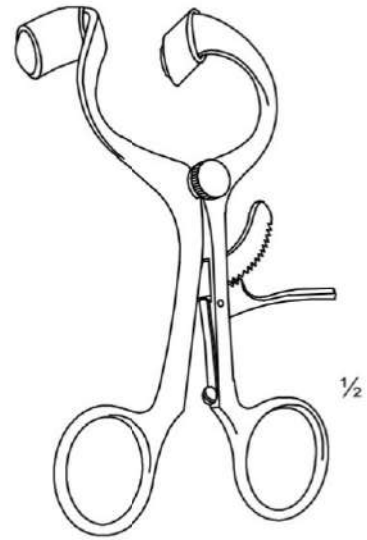

**JANSEN**

27-0200 14.0cm

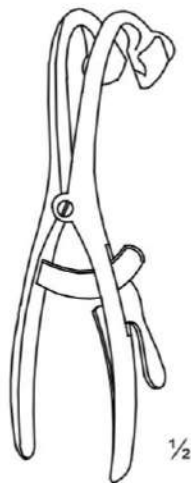

**DENHARDT**

27-0300 12.0cm

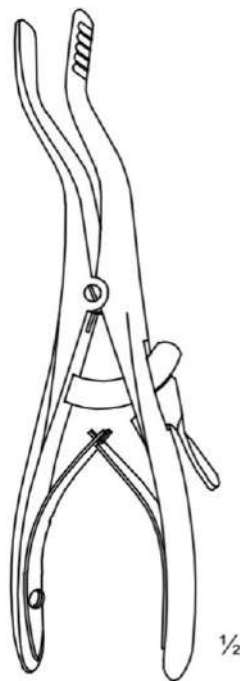

**ROSER-KONIG**

27-0401 16.0cm  
27-0402 19.0cm

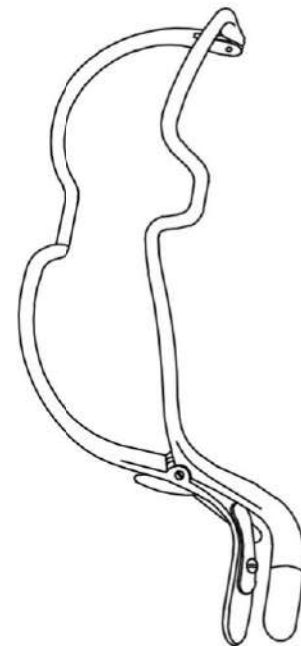

**JENNINGS**

27-0501 9.0cm  
27-0502 11.0cm  
27-0503 13.0cm  
▶ 27-0504 15.0cm

# Tongue Depressors

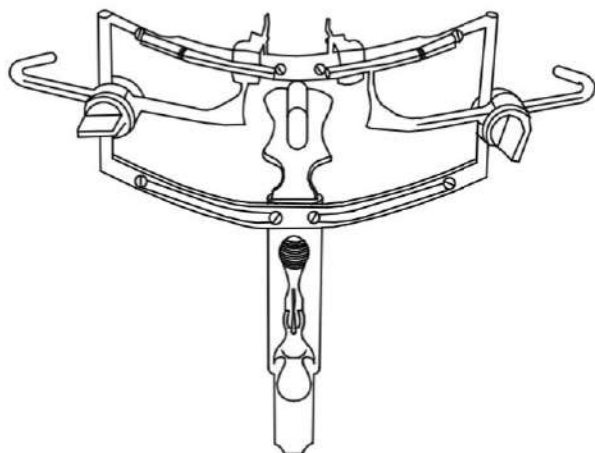

**DINGMAN SET**  
Main body & 3blades

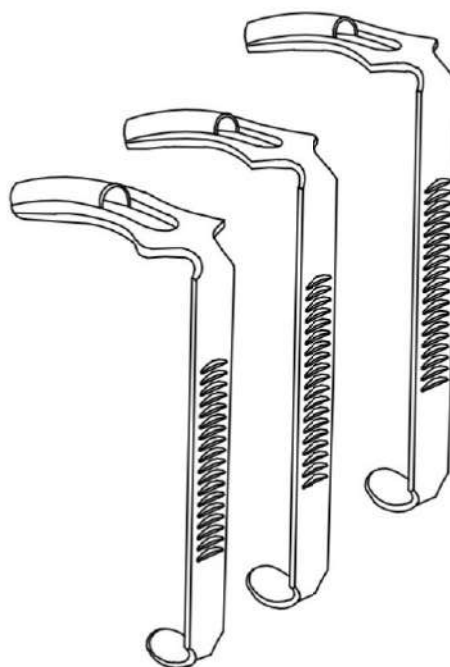

Code	Set	Dimensions
27-0600	Set	
27-0601	14.0cm	24 x 52mm
27-0602	14.0cm	28 x 55mm
27-0603	14.0cm	30 x 68mm

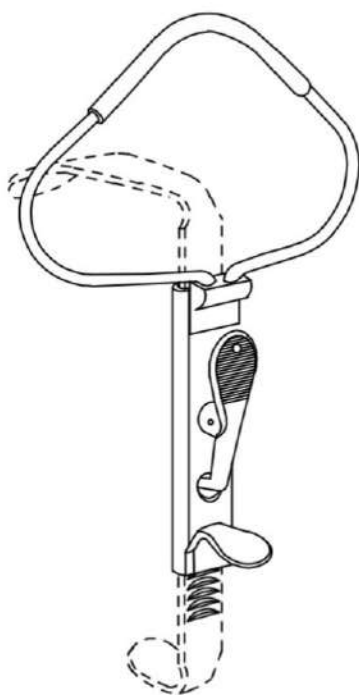

**MC IVOR SET**  
Main body & 3blades

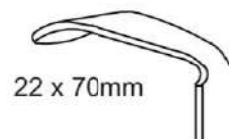
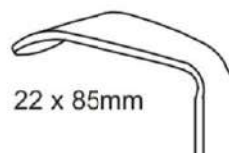
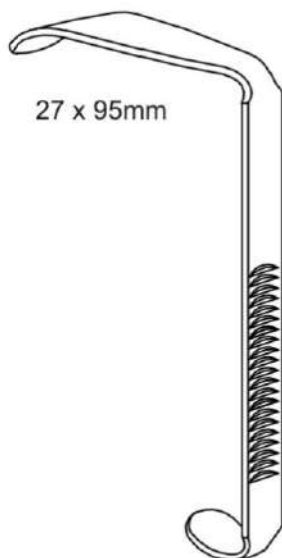

▶ 27-0700	Set	
▶ 27-0701	22 x 70mm	
▶ 27-0702	22 x 85mm	
▶ 27-0703	27 x 95mm	



- ▶ 27-0801 12.0cm
- ▶ 27-0802 15.0cm

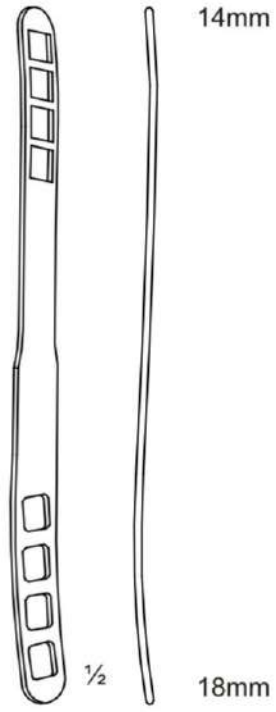

**BRUENINGS**

- ▶ 27-0900 19.0cm

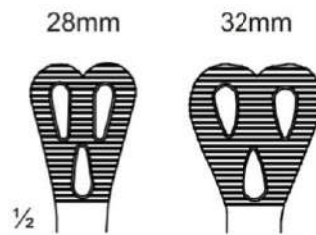
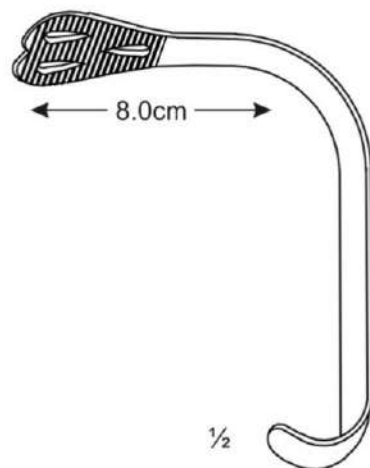

- ▶ 27-1001 28mm
- ▶ 27-1002 32mm

**WIEDER**

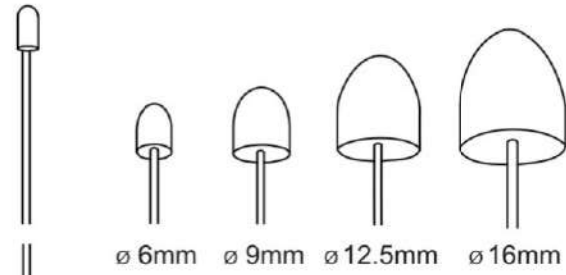

▶ 28-0101	∅ 6mm
▶ 28-0102	∅ 9mm
▶ 28-0103	∅ 12.5mm
▶ 28-0104	∅ 16mm

MYERS

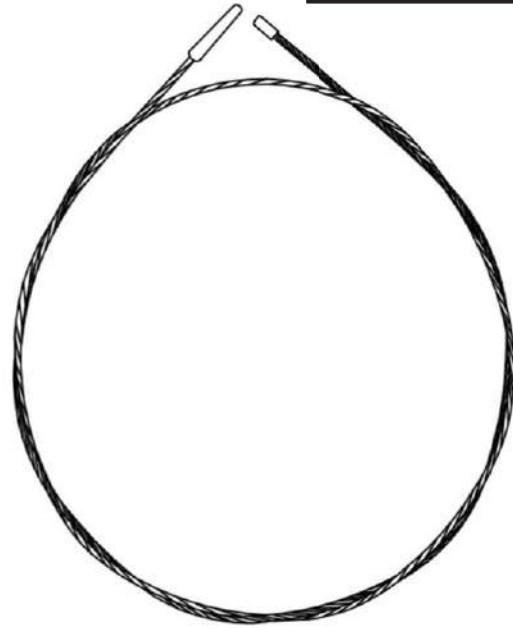

WIRE

▶ 28-0200 90.0cm

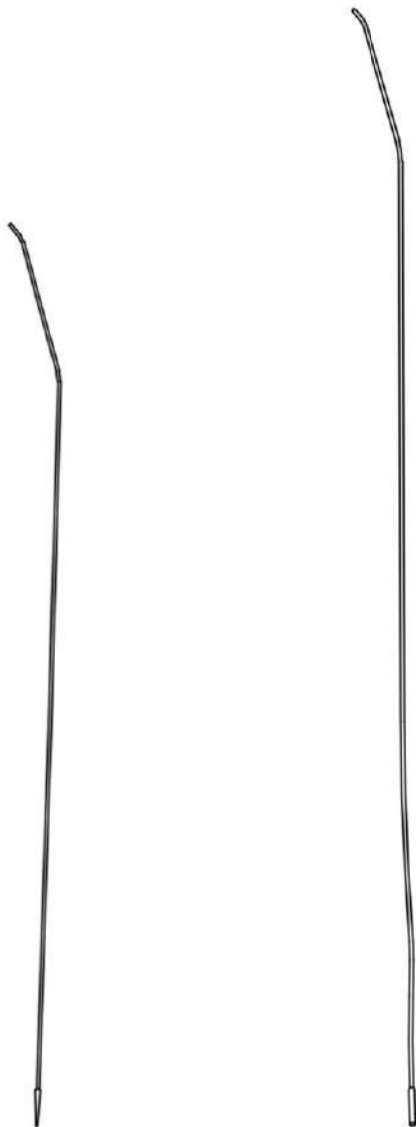

PIN

▶ 28-0301 35.0cm

PIN & WIRE

▶ 28-0302 67.0cm

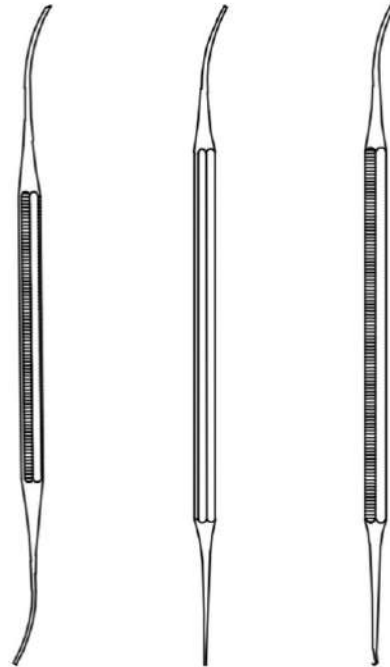

VARADY

Fig. 1

VARADY

Fig. 2

VARADY

Fig. 3

▶ 28-0401	18.0cm	Fig. 1
▶ 28-0402	18.0cm	Fig. 2
▶ 28-0403	18.0cm	Fig. 3



Double end

	∅ 1.0mm	∅ 1.5mm	∅ 2.0mm	∅ 3.5mm
11.0cm			29-0301	
13.0cm	29-0101	29-0201	29-0302	
14.0cm	29-0102	29-0202	29-0303	
16.0cm	29-0103	29-0203	29-0304	
18.0cm	29-0104	29-0204	29-0305	
20.0cm	29-0105	29-0205	29-0306	
30.0cm		29-0206	29-0307	29-0401
			29-0308	29-0402



Single end

▶ 29-0501	14.5cm
▶ 29-0502	16.0cm
▶ 29-0503	20.0cm



Dilators

▶ 29-0601	13.0cm
29-0602	14.5cm
29-0603	16.0cm

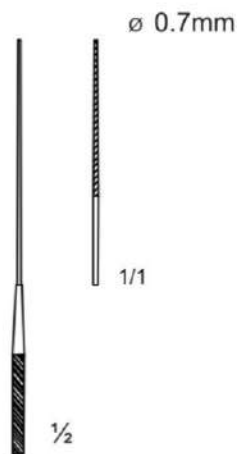

**PICCOLO**

29-0700 11.0cm

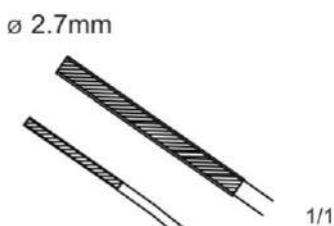

**FEIN**

29-0900 28.0cm

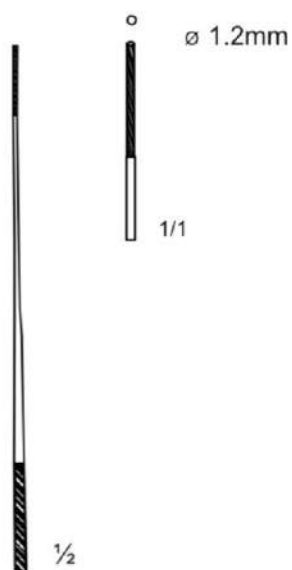

**FARREL**

29-0801 14.0cm  
29-0802 16.0cm



[info@scissors-way.com](mailto:info@scissors-way.com)



+92-302-06106808



[www.scissors-way.com](http://www.scissors-way.com)





**Maxilo-Facial Surgery**  
Maxilo-Facial Surgery



**Trachea Tubes**  
Trachea Tubes

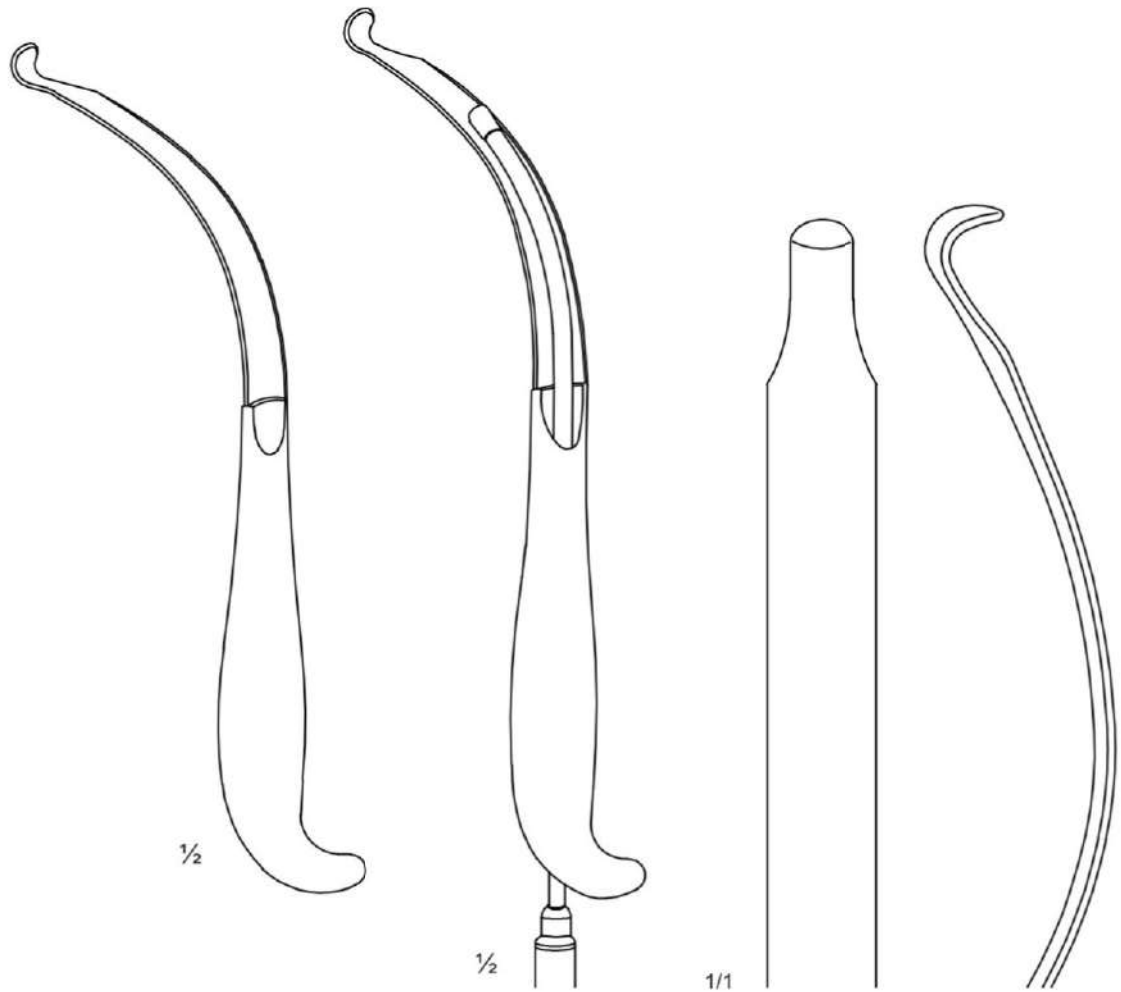

Fiber-optic

**EXTRA-ORAL RETRACTORS**

30-0101	24.0cm	
30-0101F	27.0cm	Fiber-optic

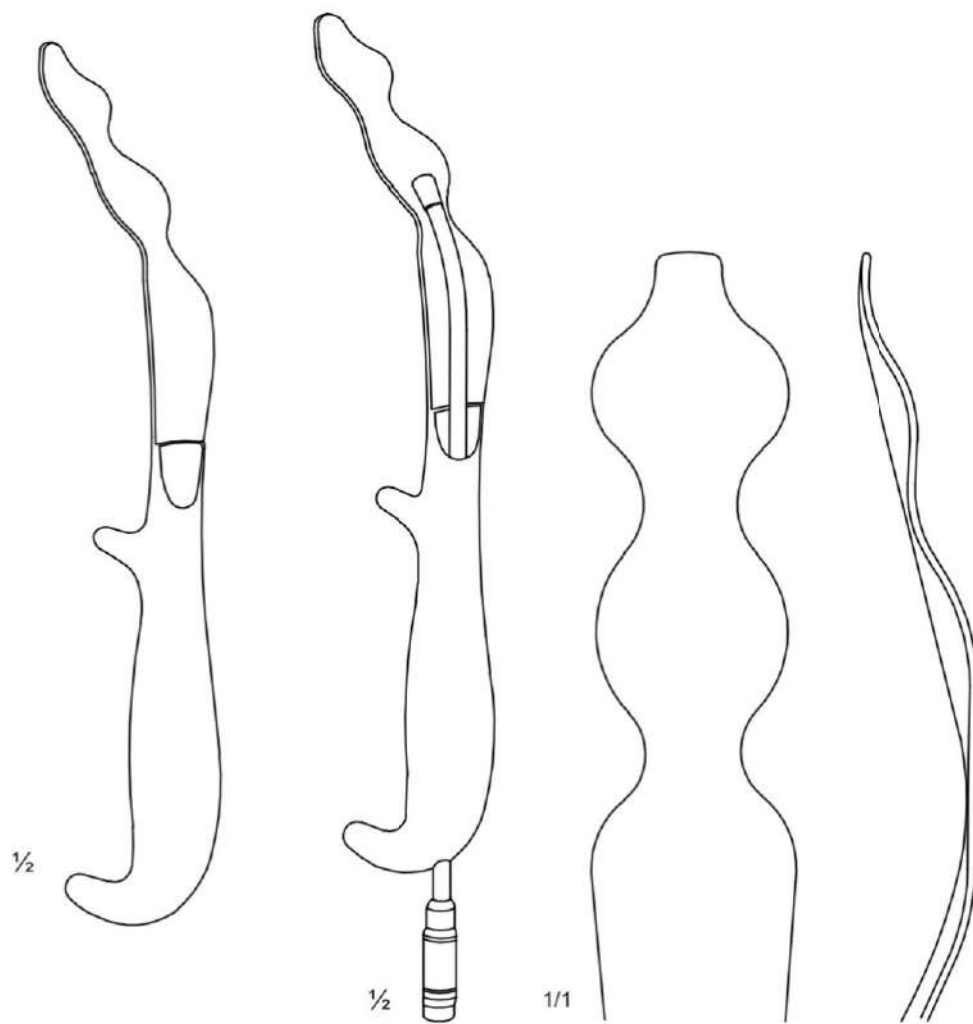

Fiber-optic

**INTRA-ORAL RETRACTORS**

30-0102	24.0cm	
30-0102F	27.0cm	Fiber-optic

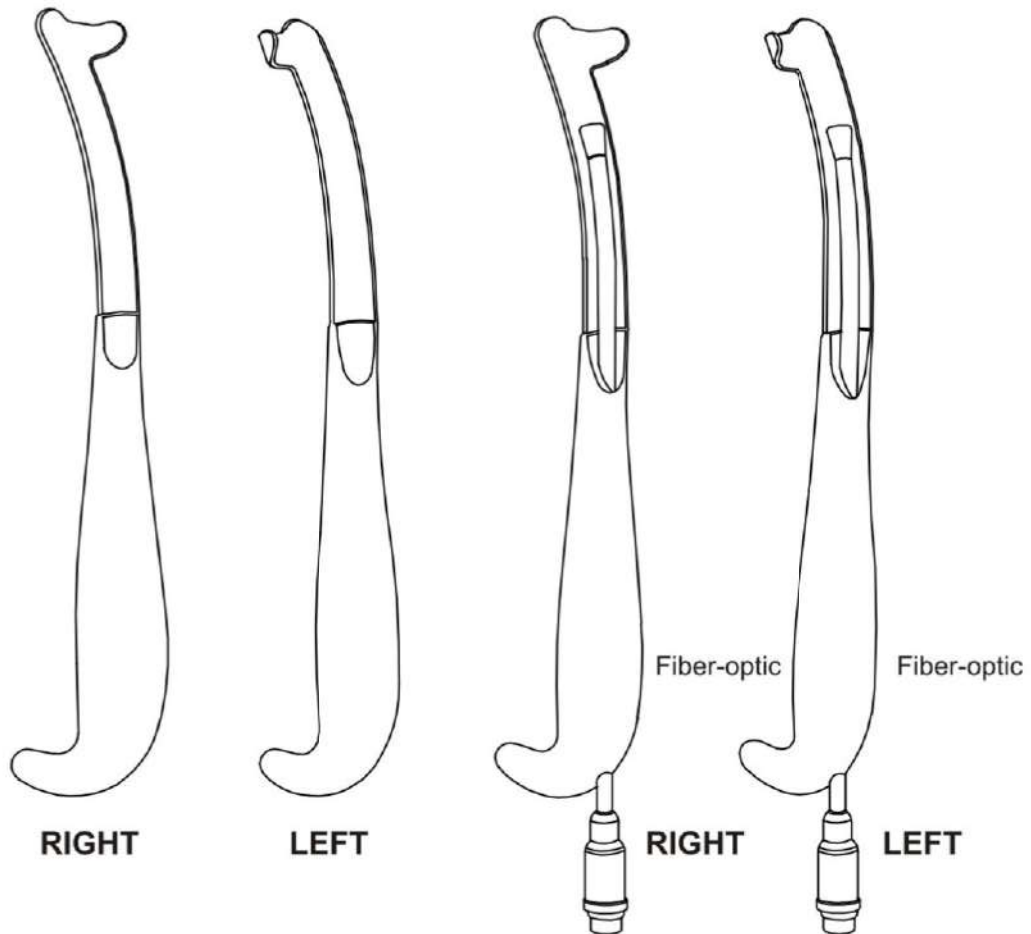
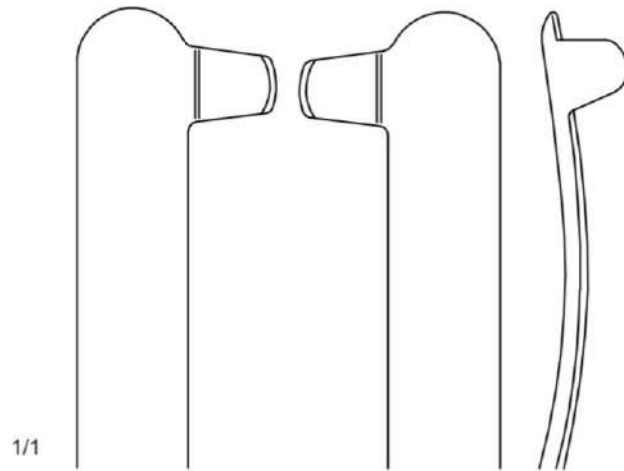

**INTRA-ORAL RETRACTORS**

30-0103	21.0cm	Right	
30-0104	21.0cm	Left	
30-0103F	24.0cm	Right	Fiber-optic
30-0104F	24.0cm	Left	Fiber-optic

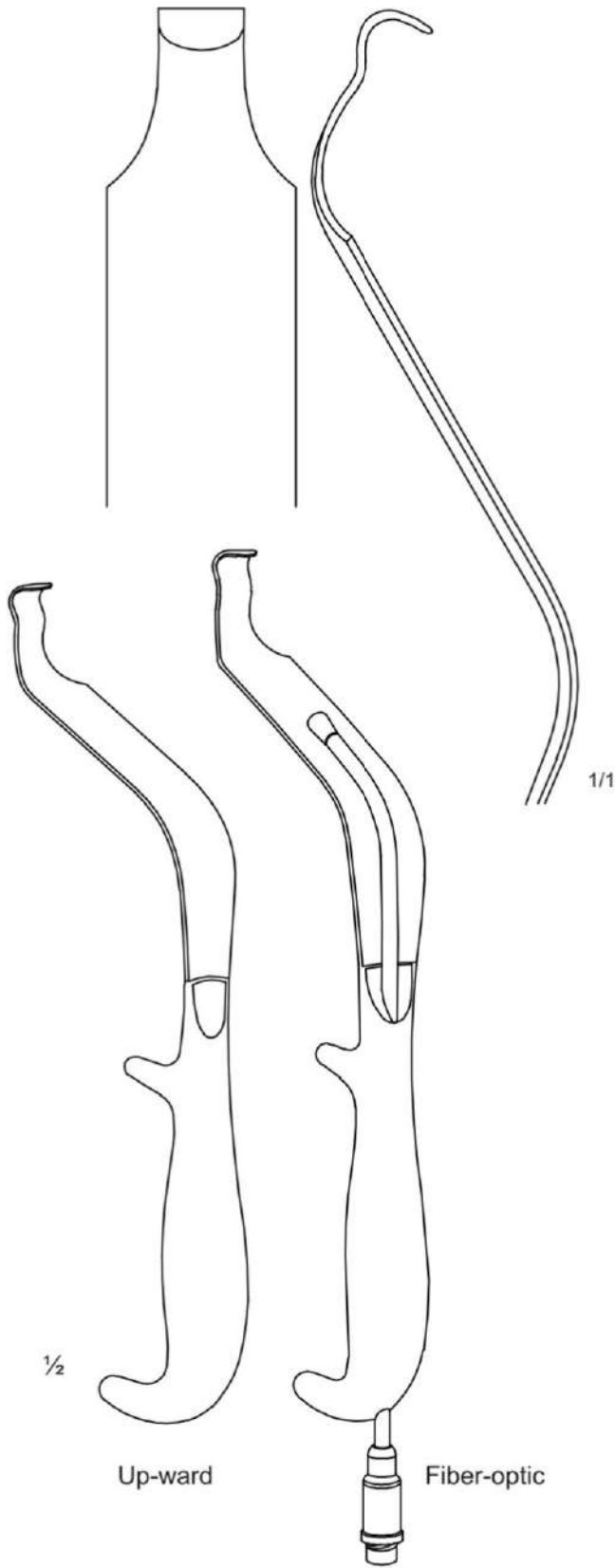

**INTRA-ORAL RETRACTORS**

30-0105	25.0cm	Up-ward
30-0105F	28.0cm	Fiber-optic



**OBWEGESER**

Awl

30-0200	14.0cm
---------	--------

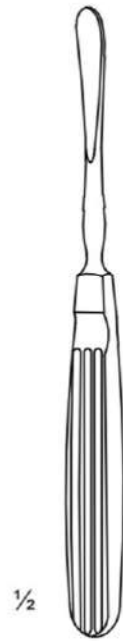

**OBWEGESER**  
Elevators

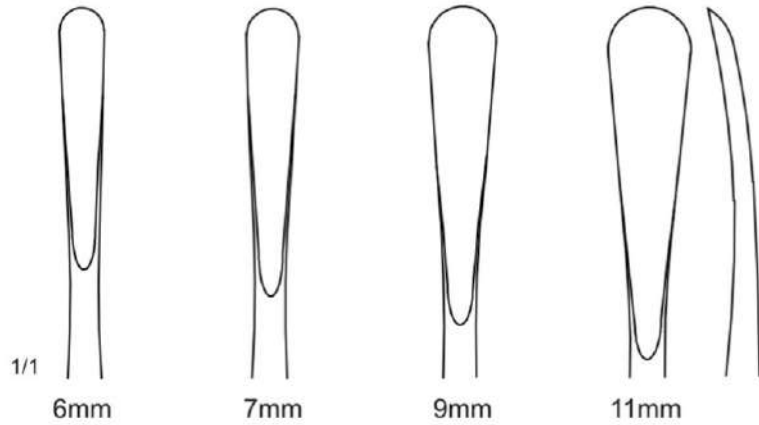

30-0301	6mm
30-0302	7mm
30-0303	9mm
30-0304	11mm



**OBWEGESER**  
Elevators

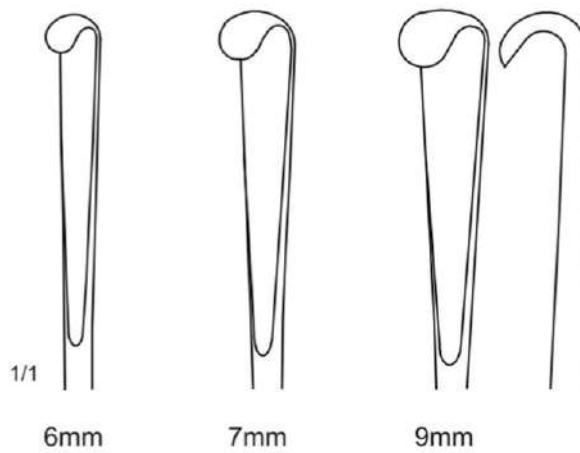

30-0401	6mm
30-0402	7mm
30-0403	9mm

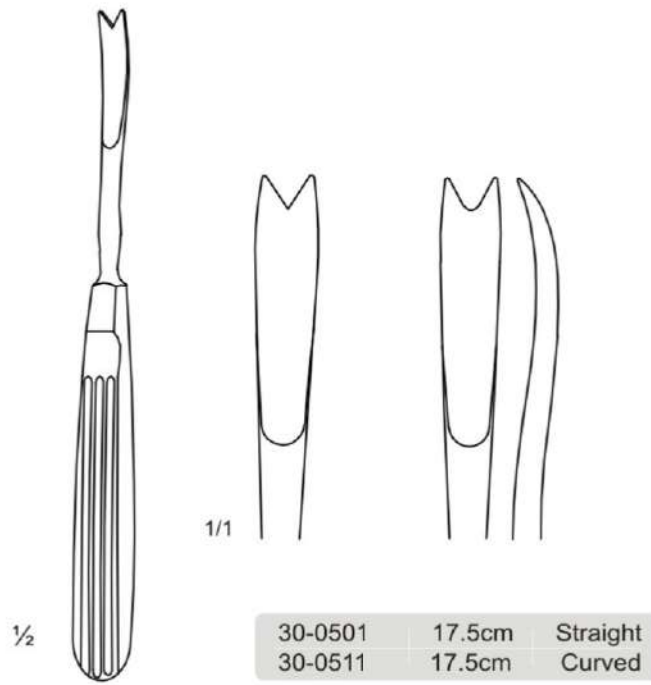

30-0501	17.5cm	Straight
30-0511	17.5cm	Curved

**OBWEGESER**  
Elevators

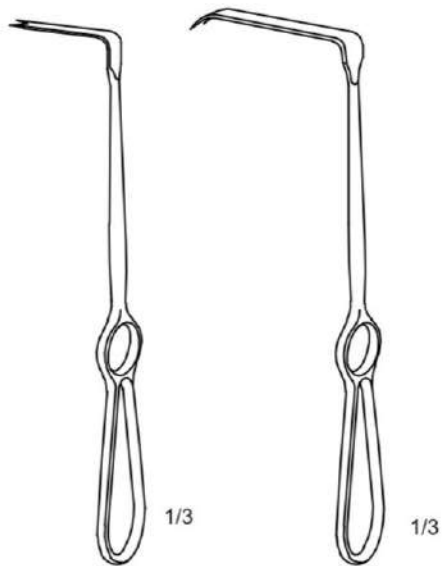

**OBWEGESER - RAMUS**  
Retractors

15-2001	22.0cm	10 x 42mm
15-2002	22.0cm	11 x 70mm
15-2003	23.0cm	13 x 70mm
15-2004	20.5cm	20 x 50mm

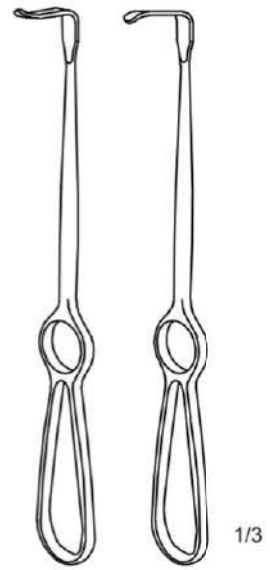

**OBWEGESER** Detail Size  
on p.179

15-1901	15-1911
15-1902	15-1912
15-1903	15-1913
15-1904	15-1914
15-1905	15-1915
15-1906	15-1916



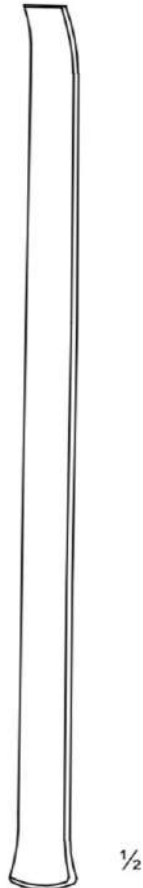

**OBWEGESER**  
Osteotomes

30-0600 23.5cm

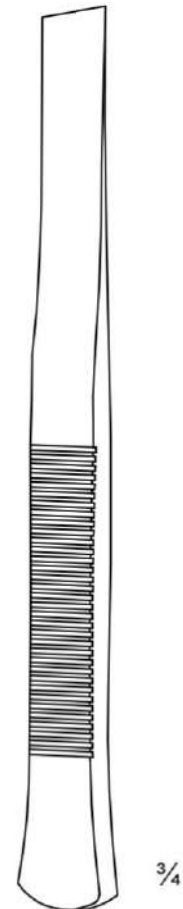

**ORIGINAL-TESSIER**  
Osteotomes

- |           |      |          |
|-----------|------|----------|
| ▶ 30-0701 | 10mm | Straight |
| ▶ 30-0702 | 14mm | Straight |
| ▶ 30-0711 | 10mm | Curved   |

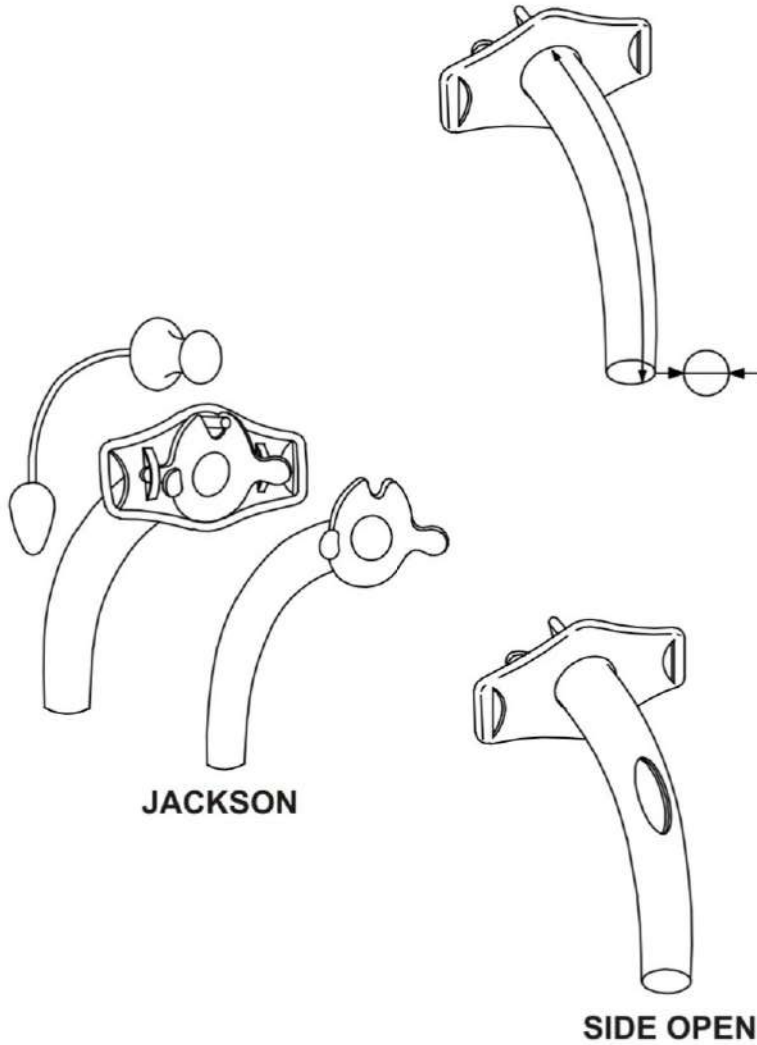

- ▶ 31-0101 # 1
- ▶ 31-0102 # 2
- ▶ 31-0103 # 3
- ▶ 31-0104 # 4
- ▶ 31-0105 # 5
- ▶ 31-0106 # 6
- ▶ 31-0107 # 7
- ▶ 31-0108 # 8
- ▶ 31-0109 # 9

- ▶ 31-0201 # 1
- ▶ 31-0202 # 2
- ▶ 31-0203 # 3
- ▶ 31-0204 # 4
- ▶ 31-0205 # 5
- ▶ 31-0206 # 6
- ▶ 31-0207 # 7
- ▶ 31-0208 # 8
- ▶ 31-0209 # 9

**INTERNATIONAL SCALE OF TRACHEA TUBE SIZES**

SIZE	1	2	3	4	5	6	7	8	9
∅ mm	5	6	7	8	9	10	11	12	13
French	15	18	21	24	27	30	33	36	39
length mm	50	55	60	65	70	75	80	85	90



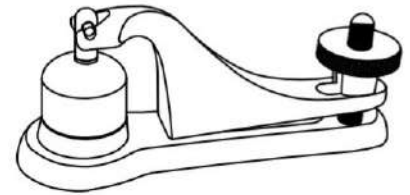

# **Urology Surgery**

Urology Surgery





- ▶ 32-0101 Small
- ▶ 32-0102 Medium
- ▶ 32-0103 Large

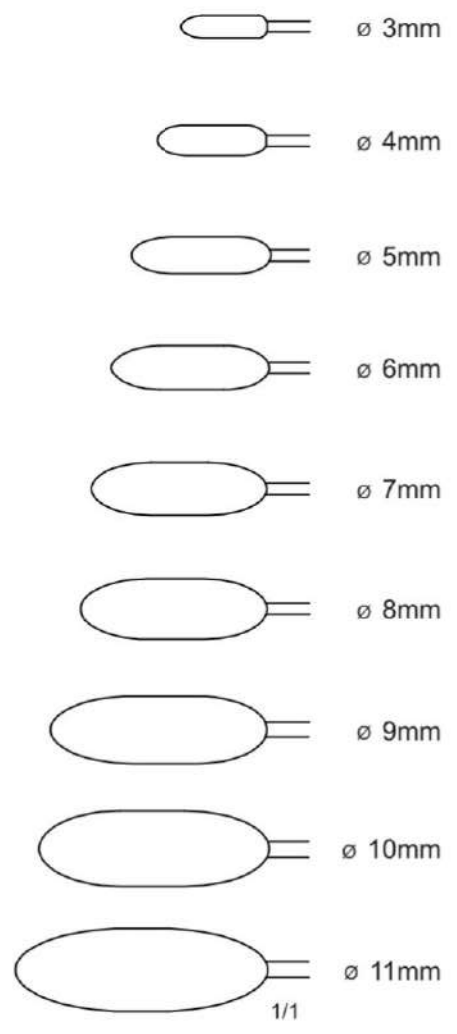

- ▶ 32-0300 Set
- ▶ 32-0303 ∅ 3mm
- ▶ 32-0304 ∅ 4mm
- ▶ 32-0305 ∅ 5mm
- ▶ 32-0306 ∅ 6mm
- ▶ 32-0307 ∅ 7mm
- ▶ 32-0308 ∅ 8mm
- ▶ 32-0309 ∅ 9mm
- ▶ 32-0310 ∅ 10mm
- ▶ 32-0311 ∅ 11mm

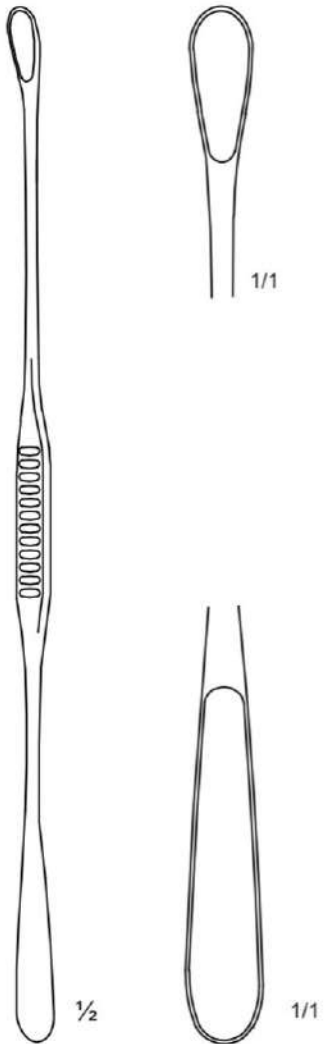

**MAYO**  
Gall Stone Scoops  
32-0400 28.0cm



**FERGUSSON**

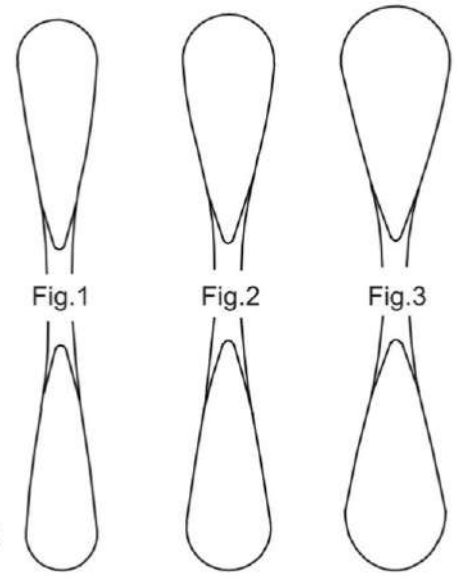

32-0501	21.5cm	Fig. 1
32-0502	22.0cm	Fig. 2
32-0503	23.5cm	Fig. 3

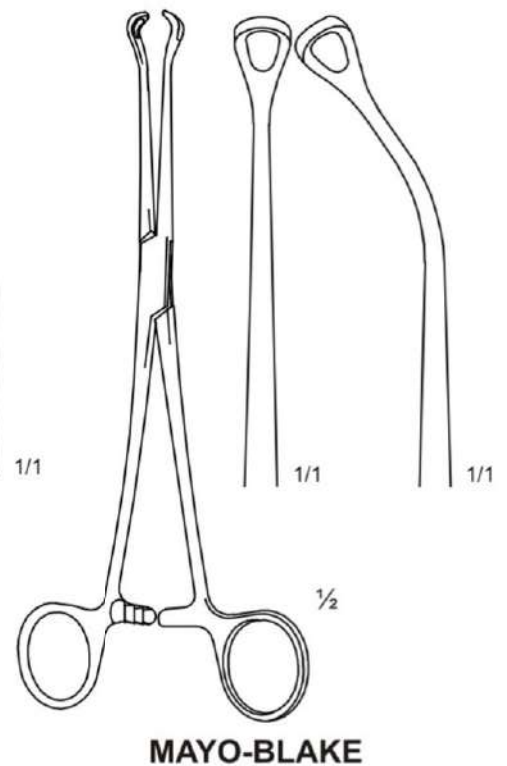
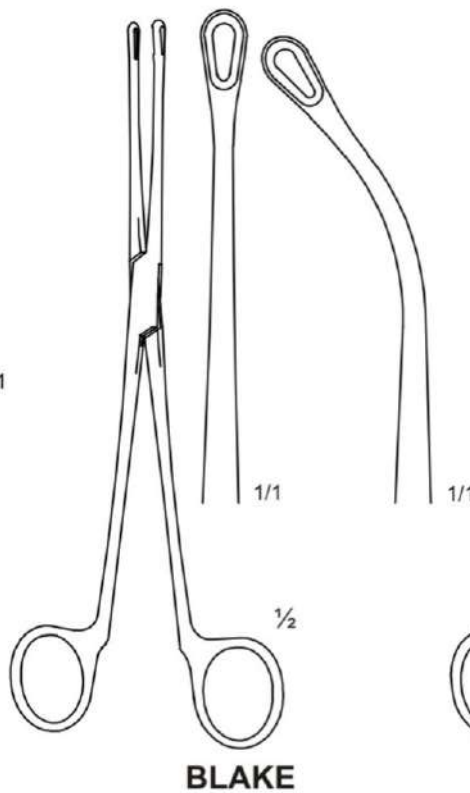
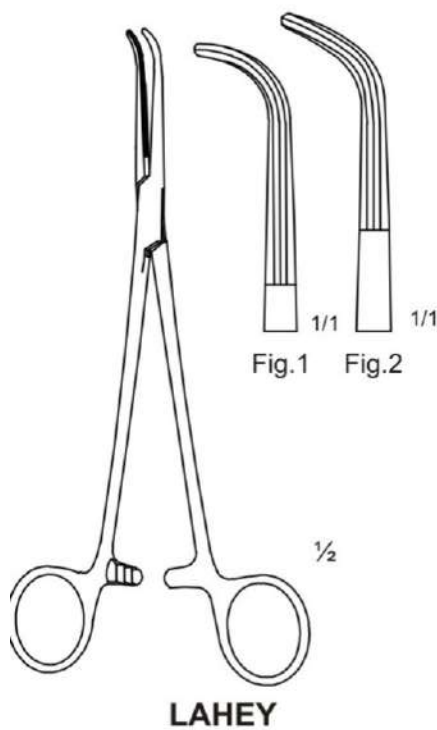
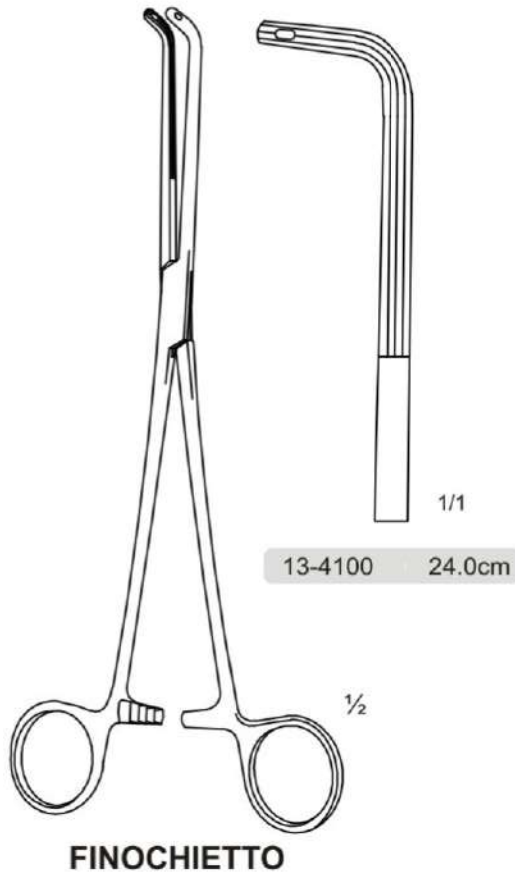



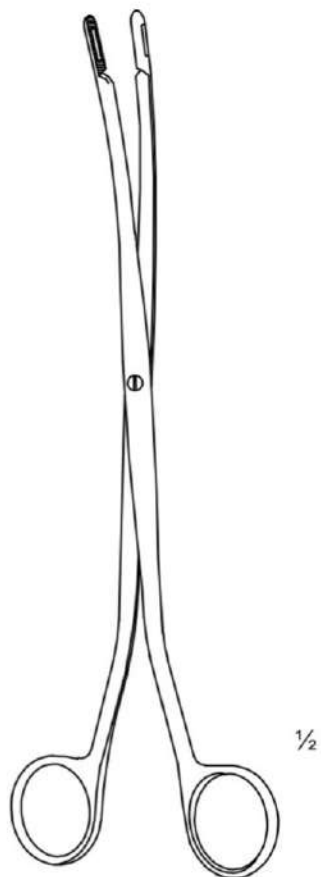

**RANDAL**

▶ 33-0101	23.0cm	Fig. 1
▶ 33-0102	22.0cm	Fig. 2
▶ 33-0103	22.0cm	Fig. 3
▶ 33-0104	22.0cm	Fig. 4

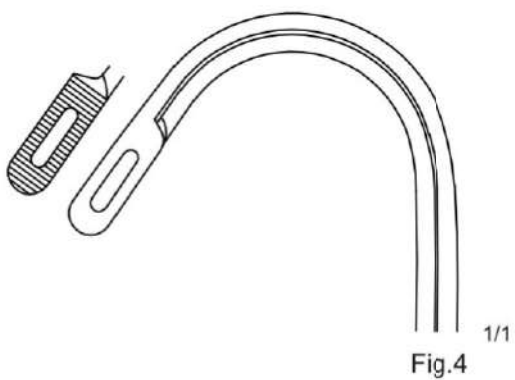
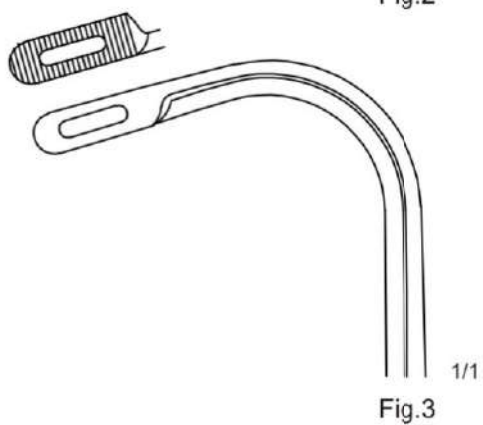
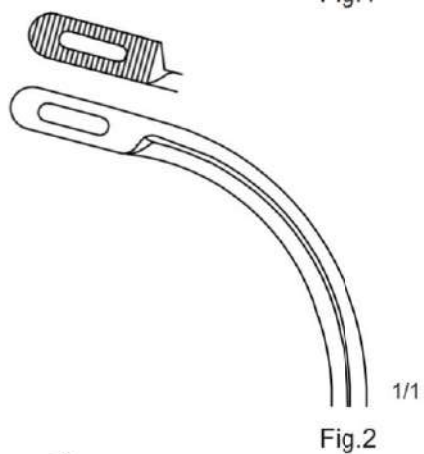
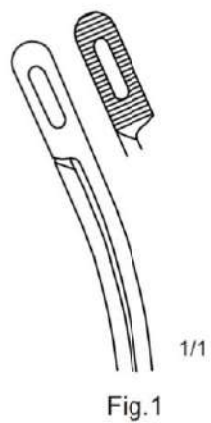

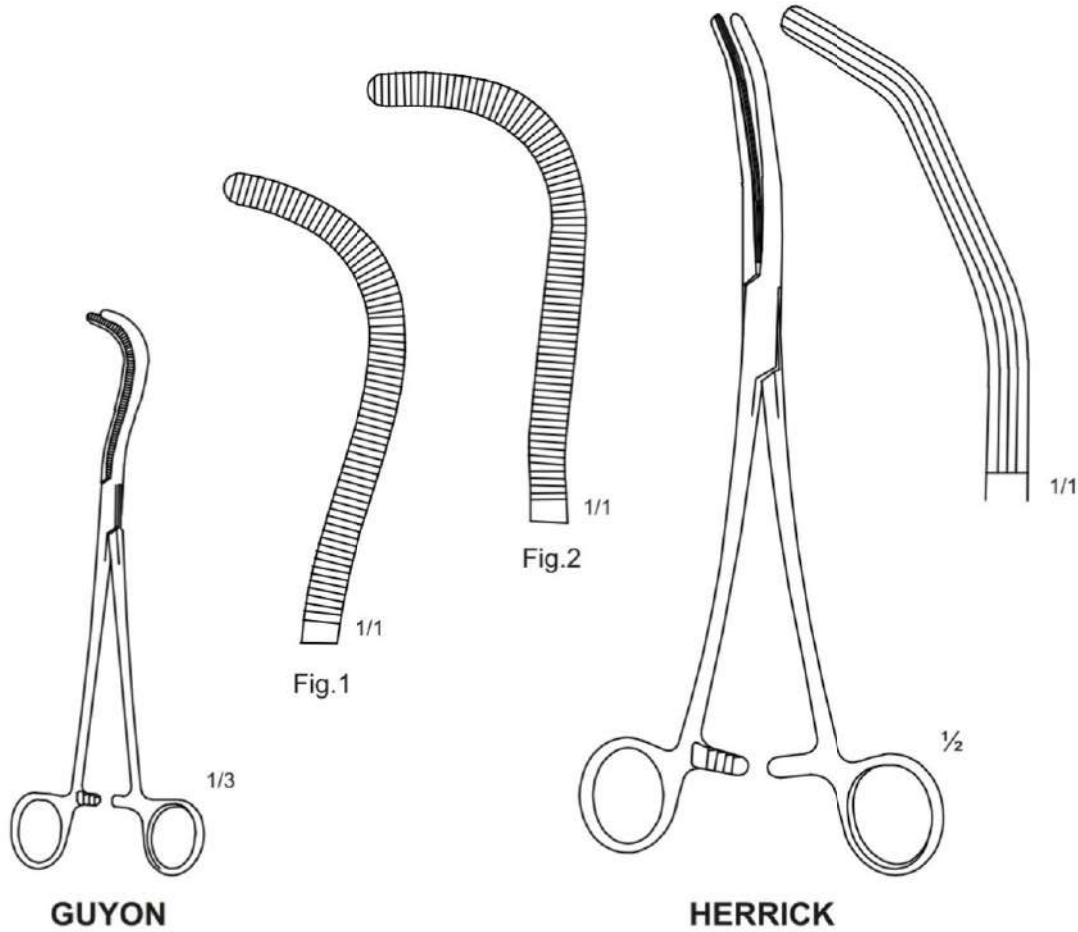
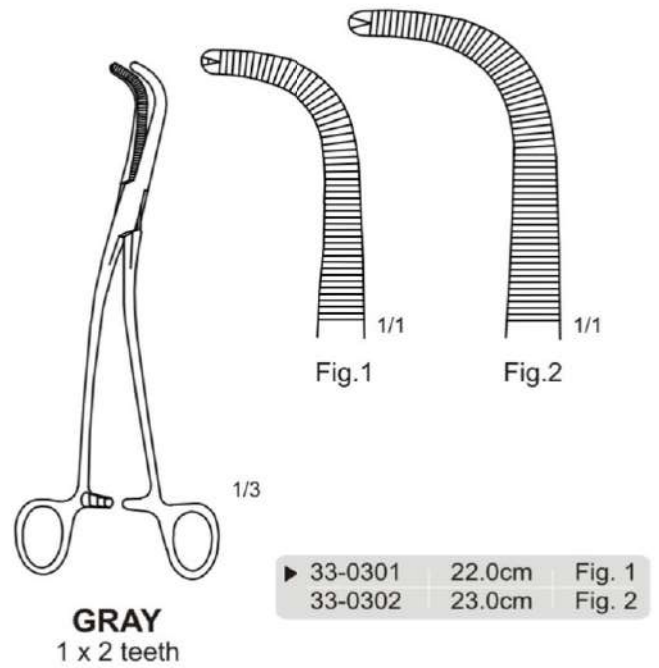
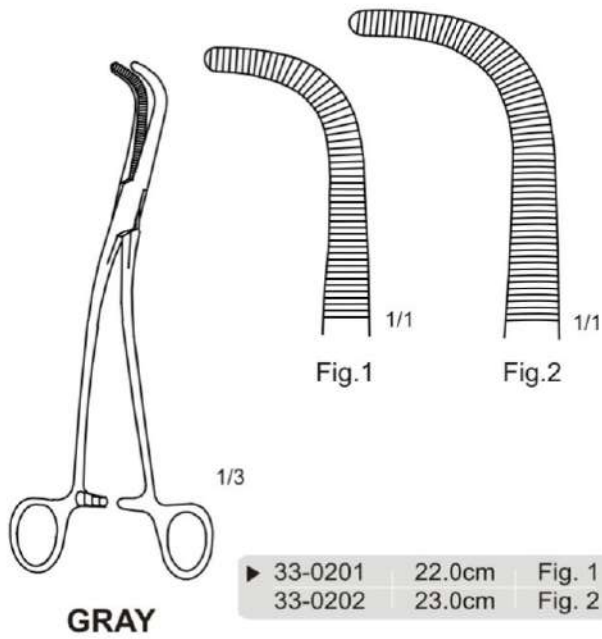

▶ 33-0401	23.5cm	Fig. 1
33-0402	23.0cm	Fig. 2

▶ 33-0500	23.0cm
-----------	--------

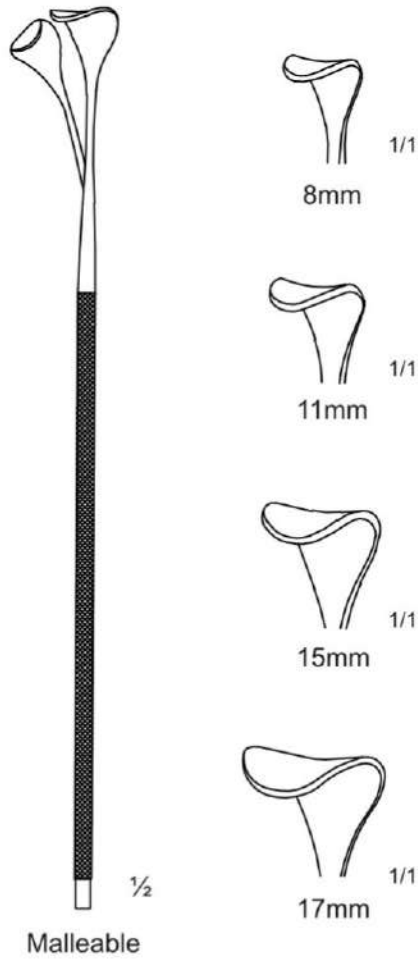

**MARBERGER (GIL-VERNET)**

- ▶ 33-0601 8mm
- ▶ 33-0602 11mm
- ▶ 33-0603 15mm
- ▶ 33-0604 17mm

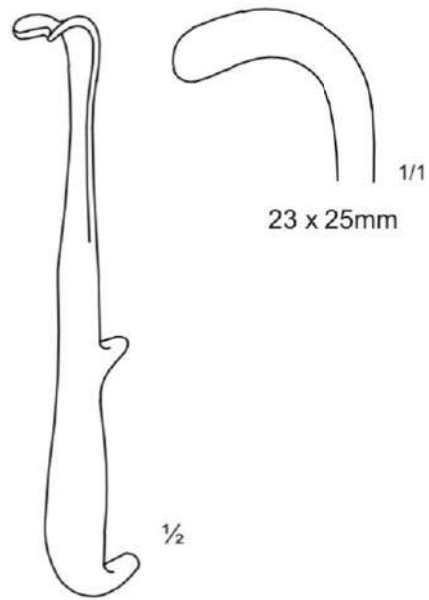

**YOUNG**

15-2300 | 23.0cm | 23 x 25mm

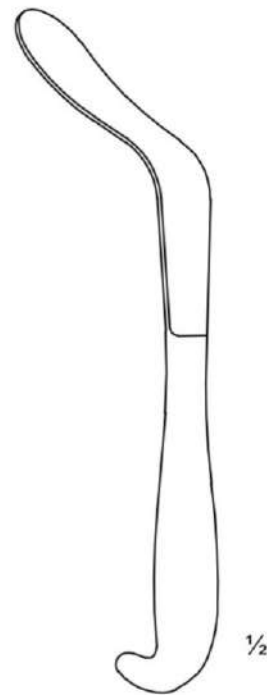

**LEGUEU**

15-2800 | 27.0cm | 100 x 35mm

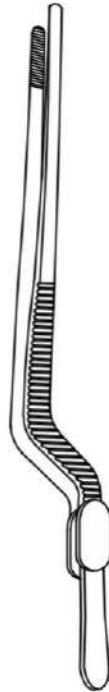

**DRESSING FORCEPS**

▶ 01-2100 | 30.0cm



**ENDO**  
Retractor  
Detail Size  
on p. 199

**MUSCLE ELEVATOR**

▶ 15-8000 | 30.0cm

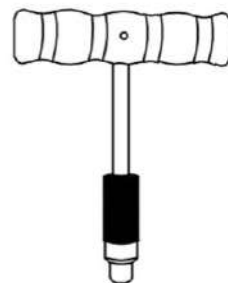

**T-HANDLE**

▶ 15-8400 | 10.0cm

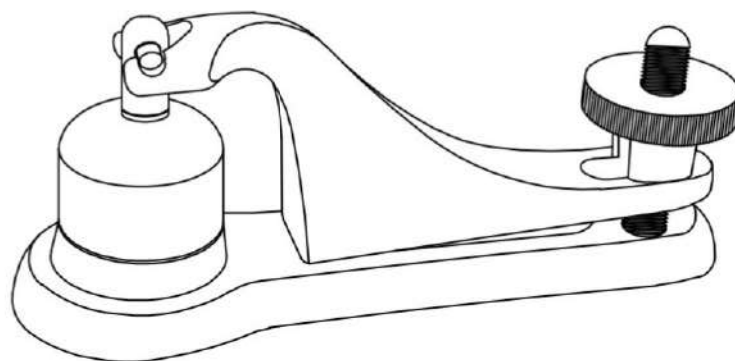

**GOMCO**

▶ 34-0101	ø 11mm	Infants
▶ 34-0102	ø 13mm	Infants
▶ 34-0103	ø 14.5mm	Children
▶ 34-0104	ø 16mm	Children
▶ 34-0105	ø 20mm	Children
▶ 34-0106	ø 24mm	Adult
▶ 34-0107	ø 26mm	Adult
▶ 34-0108	ø 28mm	Adult
▶ 34-0109	ø 32mm	Adult
▶ 34-0110	ø 35mm	Adult

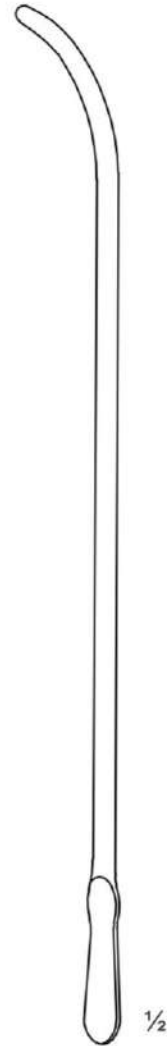

**VAN BUREN**  
Sounds

	∅ mm	Charr French
35-0101	2.8mm	8
35-0102	3.3mm	10
35-0103	4.0mm	12
35-0104	4.7mm	14
35-0105	5.3mm	16
35-0106	6.0mm	18
35-0107	6.7mm	20
35-0108	7.3mm	22
35-0109	8.0mm	24
35-0110	8.7mm	26



**STYLET**

- ▶ 35-0201 33.5cm
- ▶ 35-0202 44.0cm

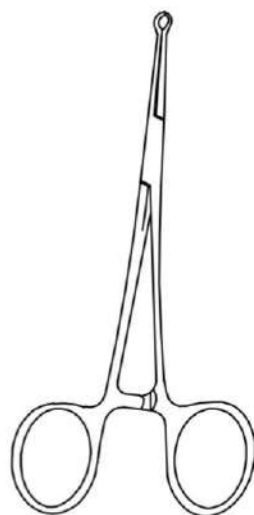

**FIXING**  
Fig. 1

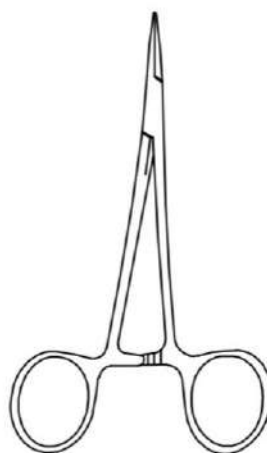

**DISSECTING**  
Fig. 2

▶ 35-0400	Vasectomy Set	
▶ 35-0400A	Fixing Forceps	Fig. 1
▶ 35-0400B	Dissecting Forceps	Fig.2





[info@scissros-way.com](mailto:info@scissros-way.com)



+92-302-06106808



[www.scissors-way.com](http://www.scissors-way.com)

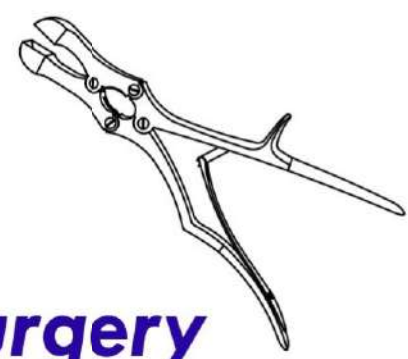

**Orthopedic Surgery**  
Orthopedic Surgery



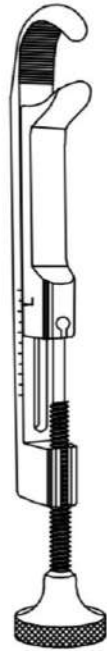

1/2

### LOWMAN

▶ 36-0101	12.0cm
▶ 36-0102	18.5cm
▶ 36-0103	20.0cm

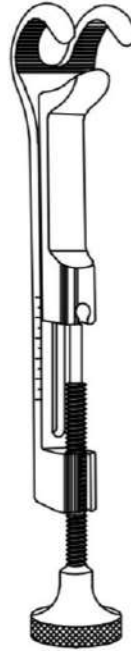

1/2

### LOWMAN

▶ 36-0201	12.0cm
▶ 36-0202	18.5cm
▶ 36-0203	20.0cm

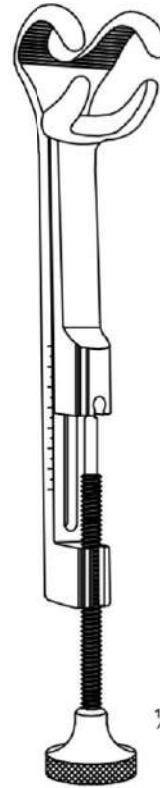

1/2

### LOWMAN-LAMBERT

36-0301	18.5cm
36-0302	20.0cm

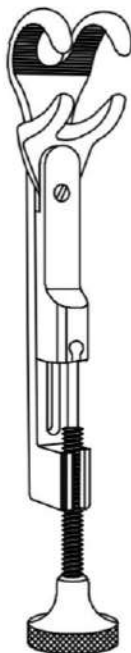

1/2

### LOWMAN-HOGLUND

1 Jaw swiveled

36-0401	12.0cm
36-0402	18.0cm
36-0403	20.0cm

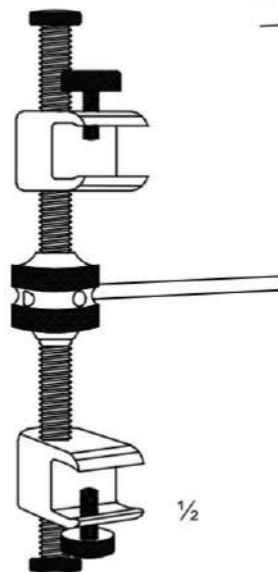
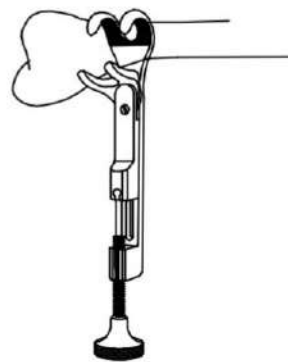

1/2

### GERSTER

Traction bar for bone clamps

36-0500
---------

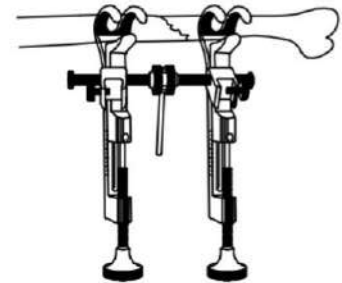

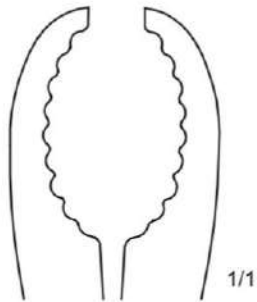

1/1

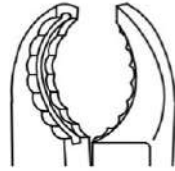

1/1

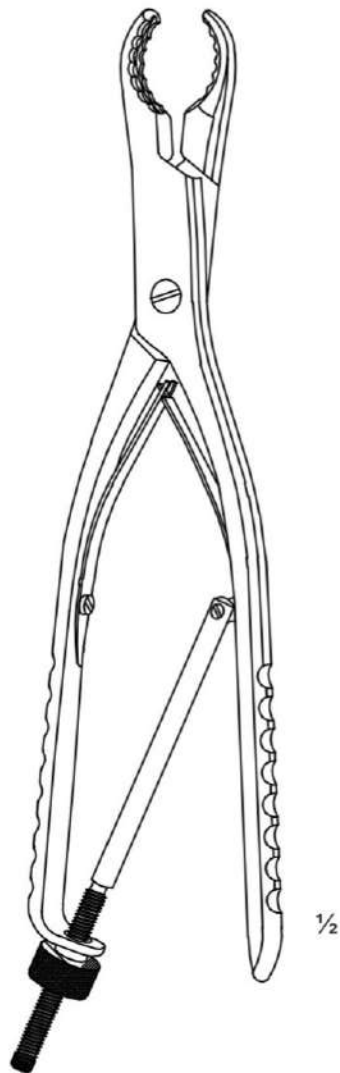

1/2

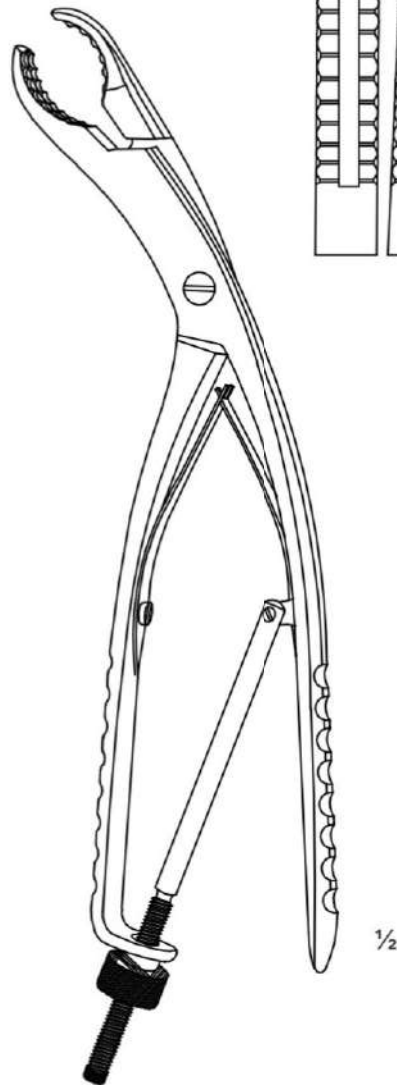
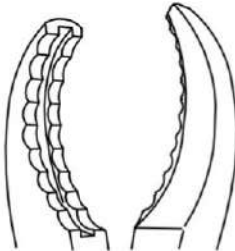
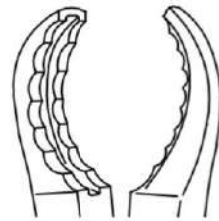

1/2

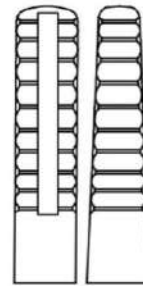

**ULRICH**

36-0601	23.0cm	Straight
36-0602	25.0cm	Straight
36-0603	28.0cm	Straight

**ULRICH**

36-0611	23.0cm	Curved
36-0612	26.0cm	Curved
36-0613	28.0cm	Curved

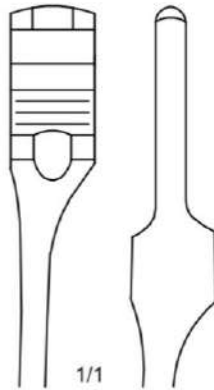

B  
11.0mm

A  
4.5mm

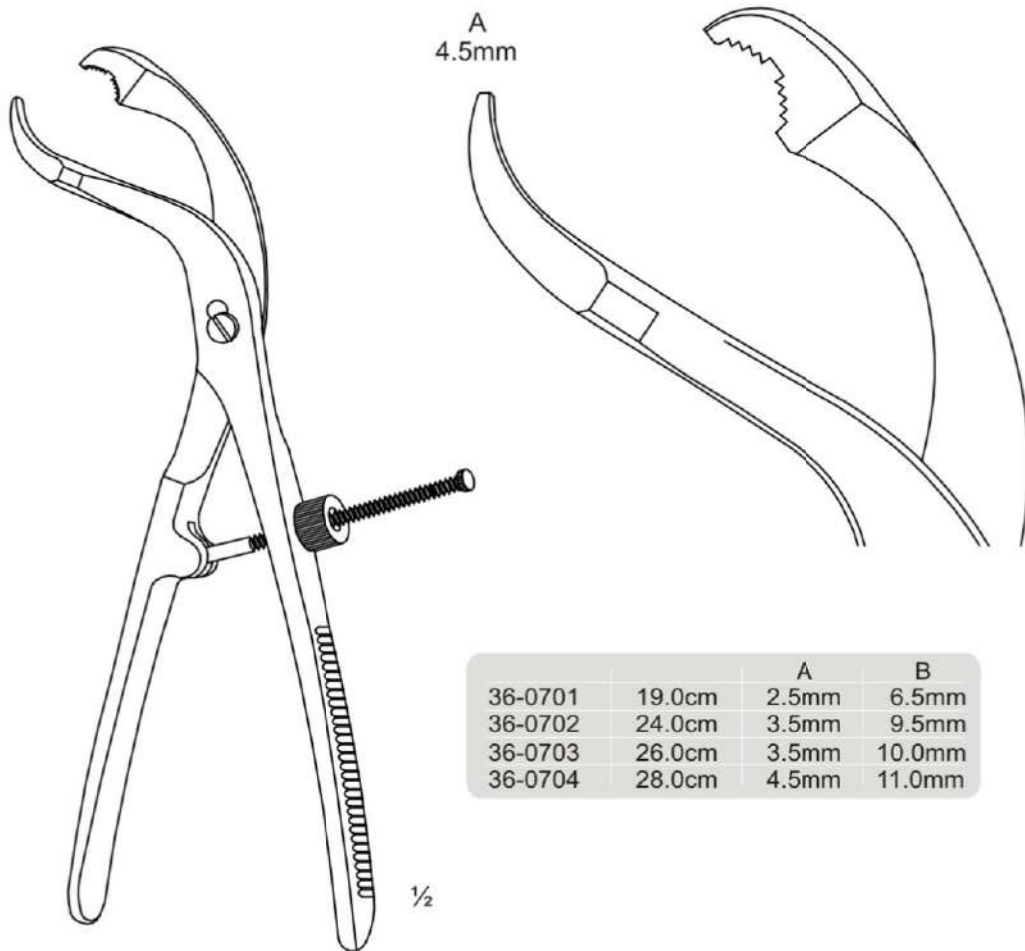

**SELF CENTERING**

		A	B
36-0701	19.0cm	2.5mm	6.5mm
36-0702	24.0cm	3.5mm	9.5mm
36-0703	26.0cm	3.5mm	10.0mm
36-0704	28.0cm	4.5mm	11.0mm

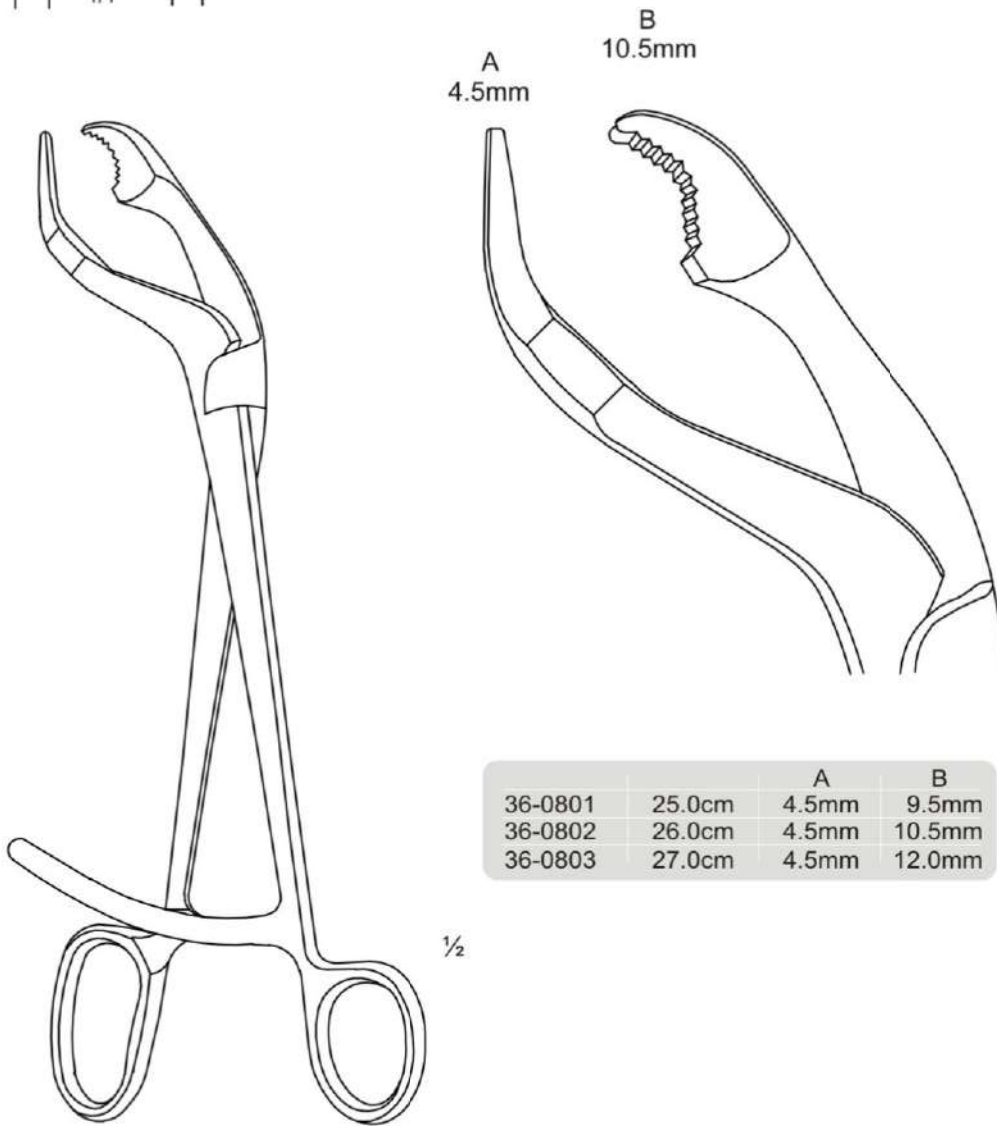
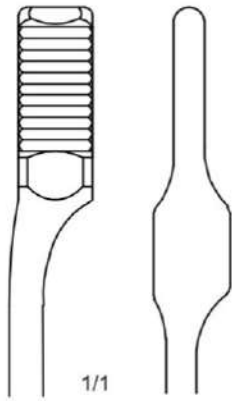

A  
4.5mm

B  
10.5mm

		A	B
36-0801	25.0cm	4.5mm	9.5mm
36-0802	26.0cm	4.5mm	10.5mm
36-0803	27.0cm	4.5mm	12.0mm

**VERBRUGGE**

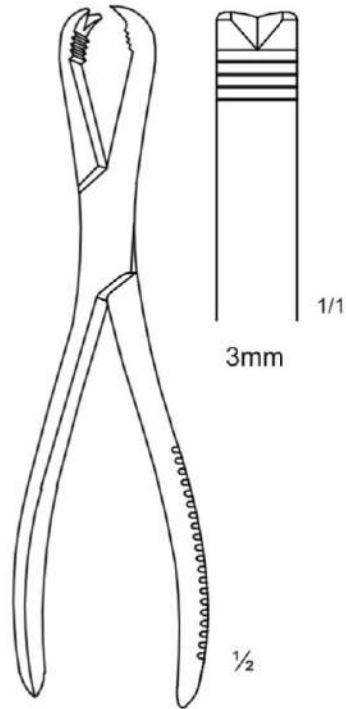

**LANGENBECK**

36-0900 21.0cm

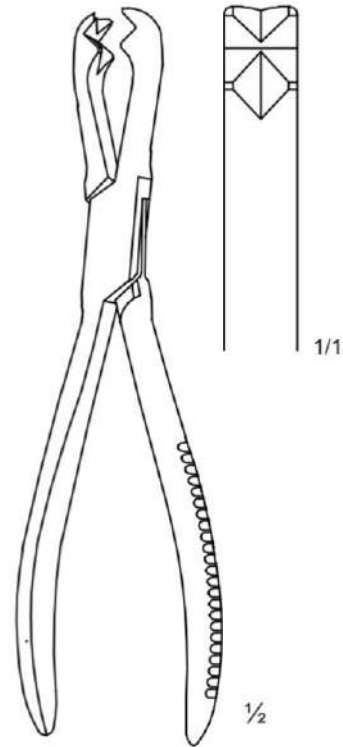

**FERGUSSON**

36-1000 21.0cm

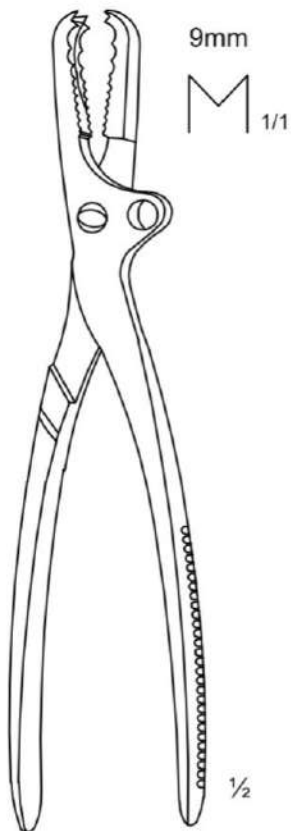

**FARABEU**

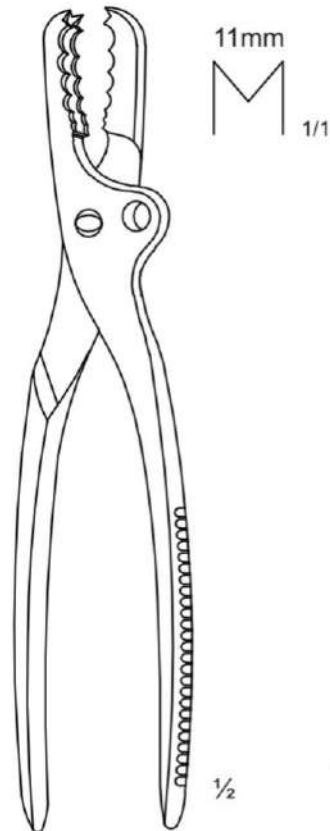

**FARABEU**

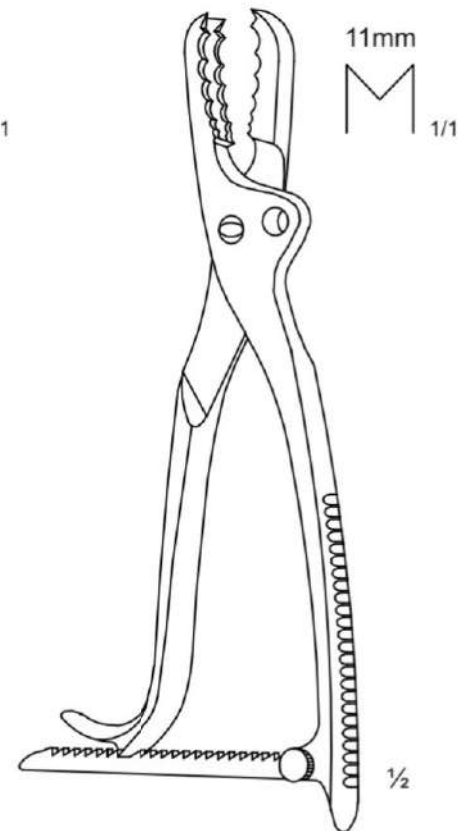

**FARABEU**



**Bone Holding Forceps**

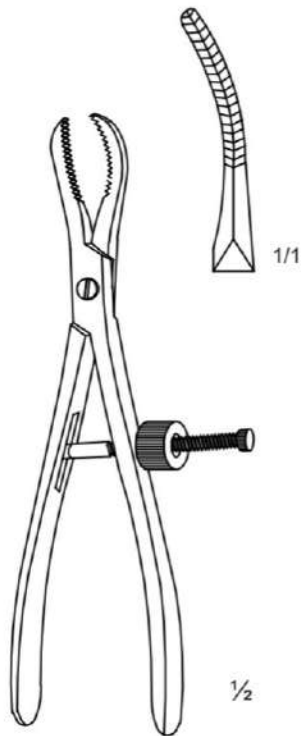

**REPOSITIONING**

36-1201 17.0cm

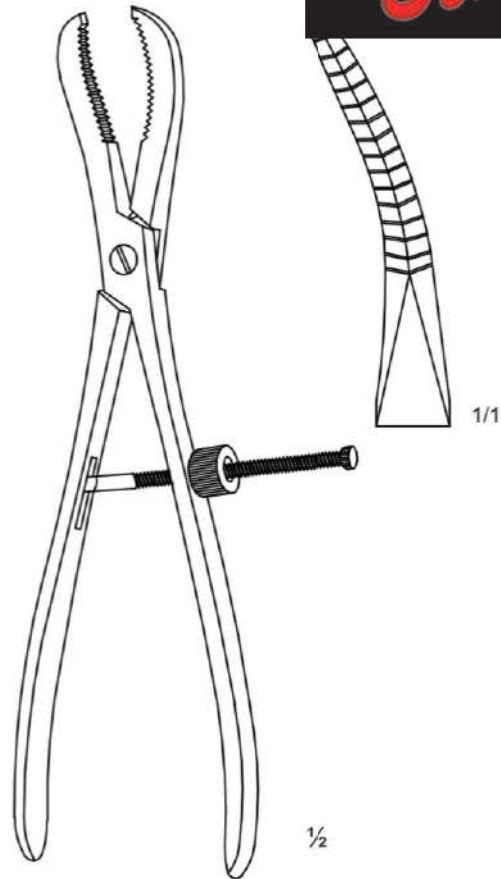

**REPOSITIONING**

36-1202 23.5cm

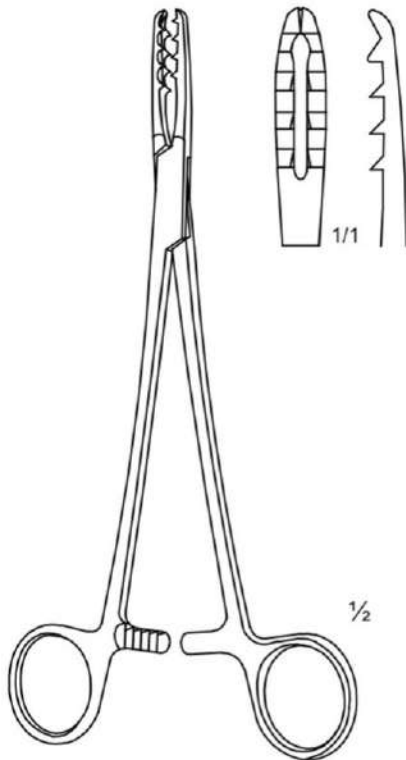

**BIRCHER-GANSKE**

36-1300 20.0cm

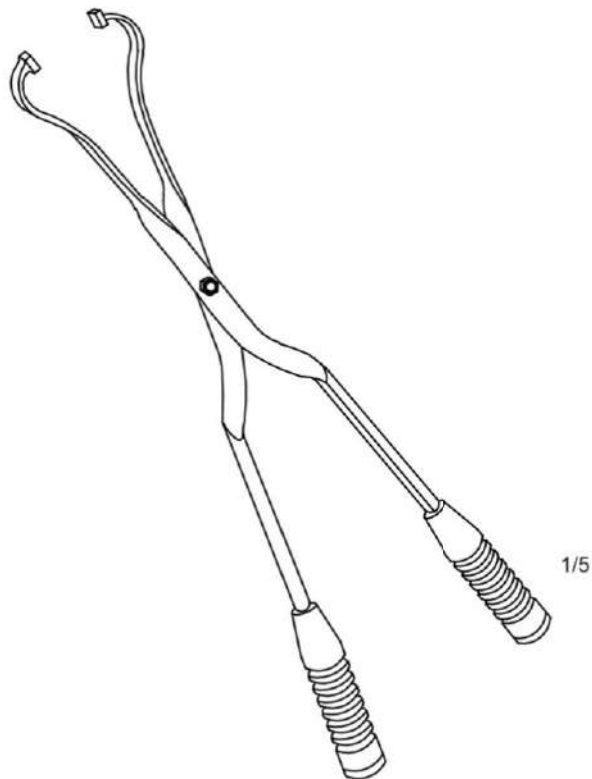

**CALCANEUS**

▶ 36-1400 54.0cm

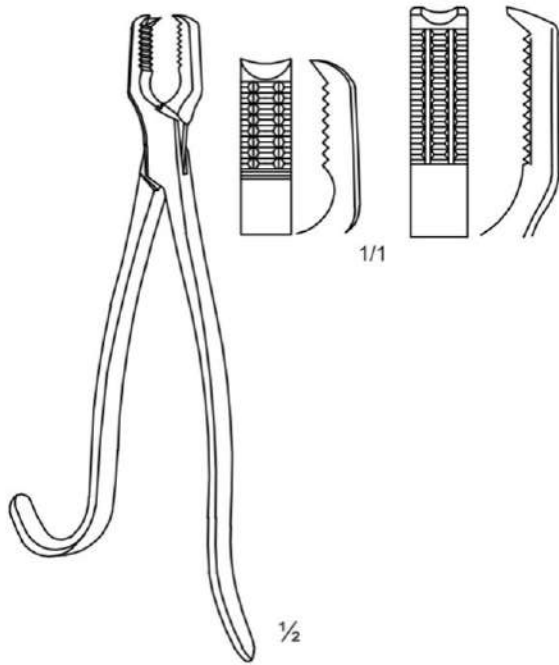

**KERN**

36-1501	17.0cm	without Ratchet
36-1502	21.0cm	without Ratchet

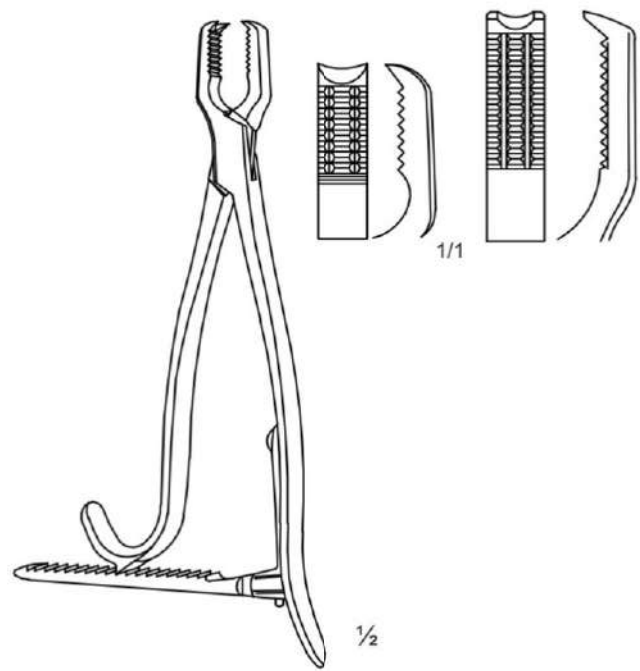

**KERN**

36-1503	17.0cm	with Ratchet
36-1504	21.0cm	with Ratchet

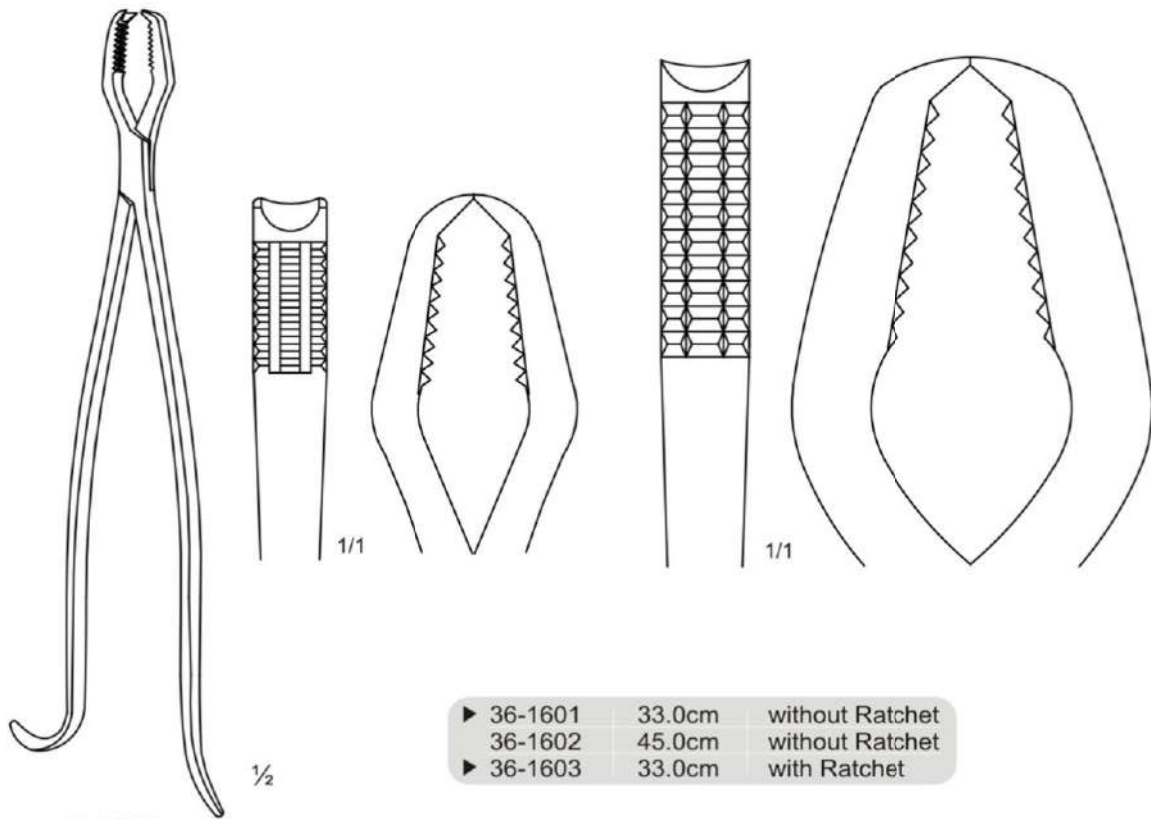

**LANE**

▶ 36-1601	33.0cm	without Ratchet
▶ 36-1602	45.0cm	without Ratchet
▶ 36-1603	33.0cm	with Ratchet

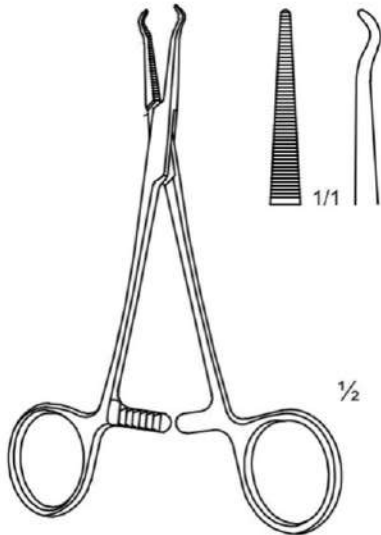

**REPOSITIONING**

▶ 36-1700 14.0cm

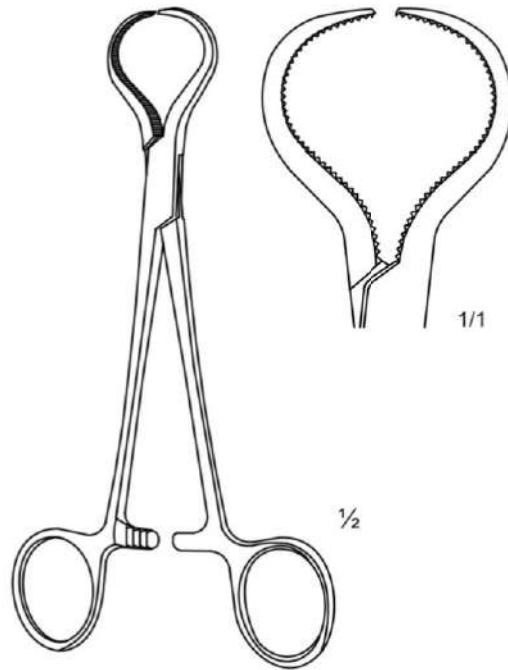

**LEWIN**

▶ 36-1701 17.5cm

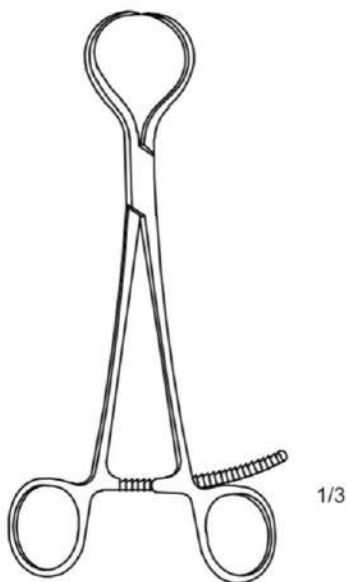

**BONE HOLDING**

▶ 36-1702 20.5cm

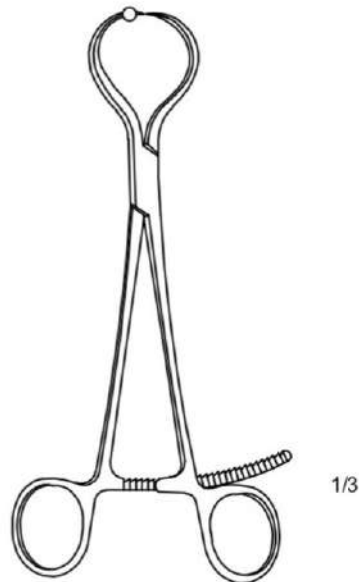

**BONE HOLDING  
with ball stop**

▶ 36-1703 20.5cm

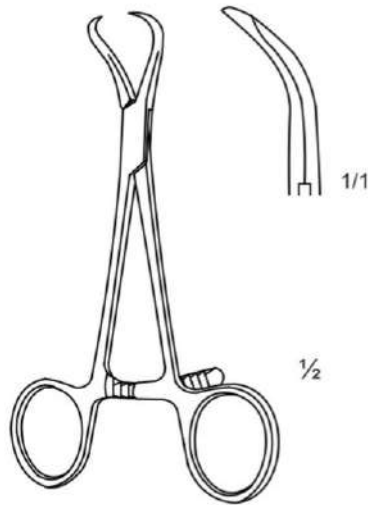

**REPOSITIONING**

36-1801	9.5cm
36-1802	14.0cm

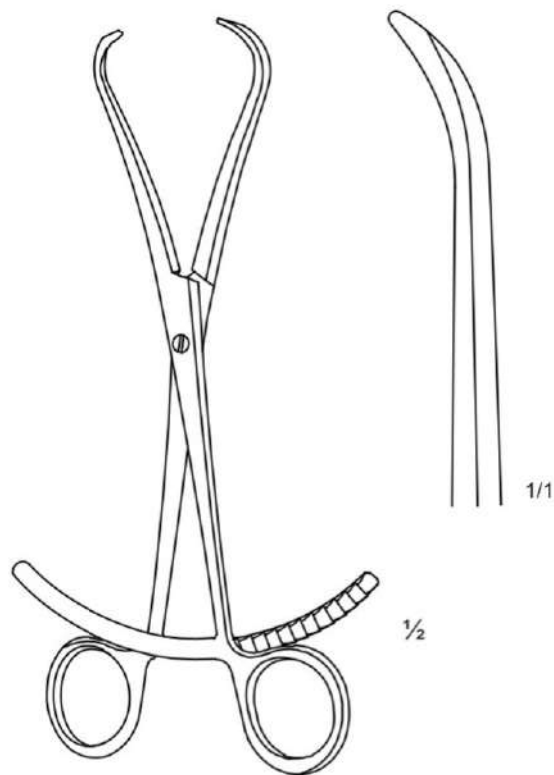

**REPOSITIONING**

36-1803	20.0cm
---------	--------

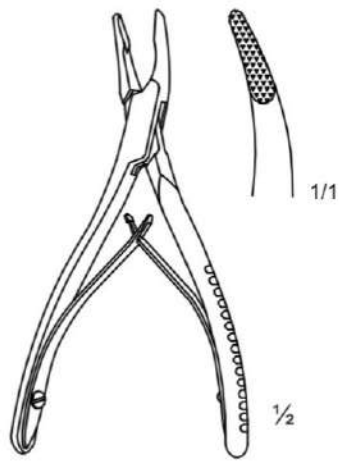

**MINI-FRIEDMANN**

36-1901 12.0cm

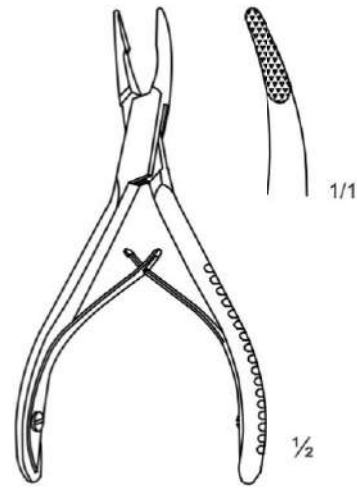

**FRIEDMANN**

36-1902 14.0cm

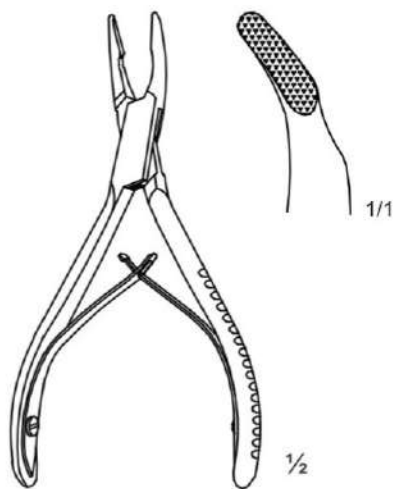

**CLEVELAND**

36-2001 14.0cm

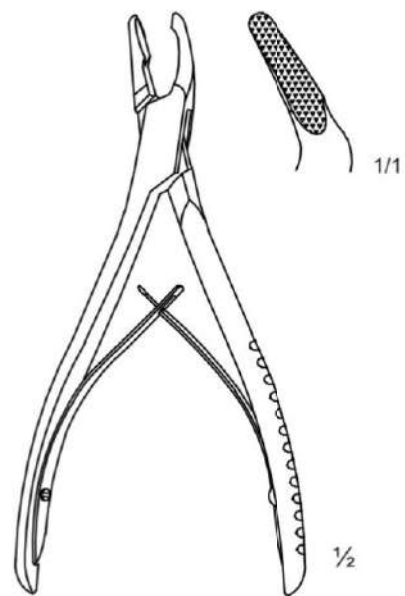

**CLEVELAND**

36-2002 17.0cm

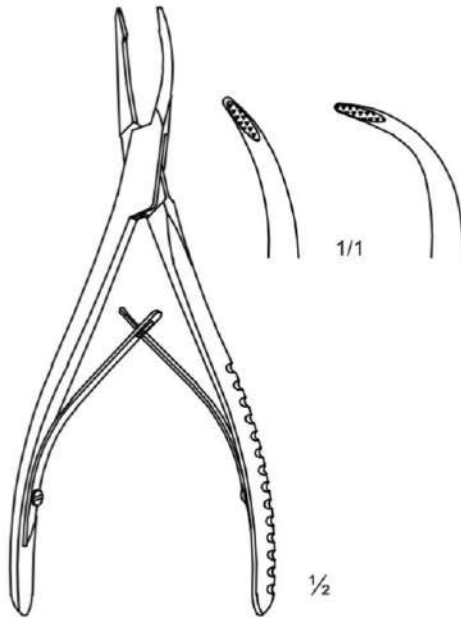

**STELLBRINK**

36-2101	2mm	Slightly Curved
36-1802	2mm	Strongly Curved

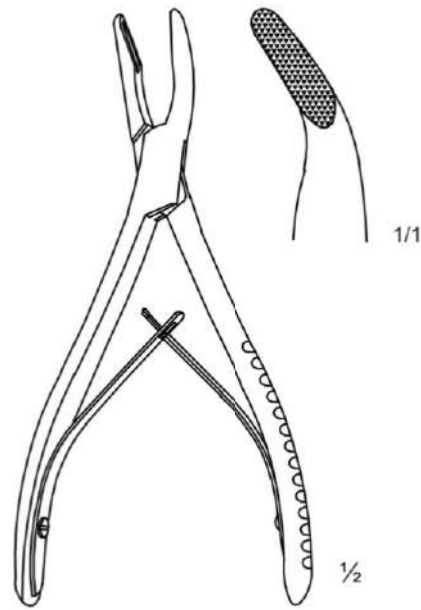

**MEAD**

36-2200	16.5cm
---------	--------

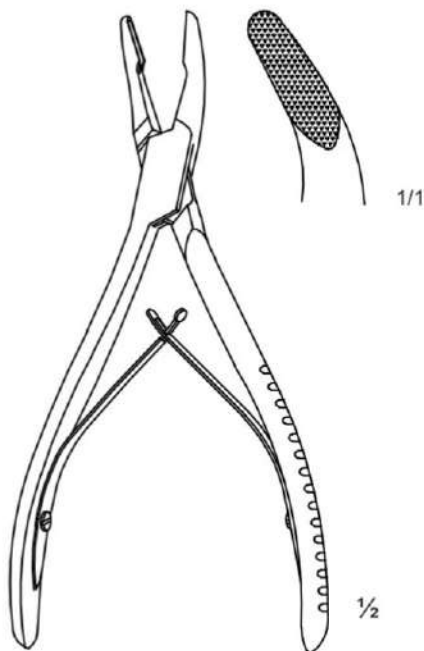

**HARTMANN**

36-2300	18.5cm
---------	--------

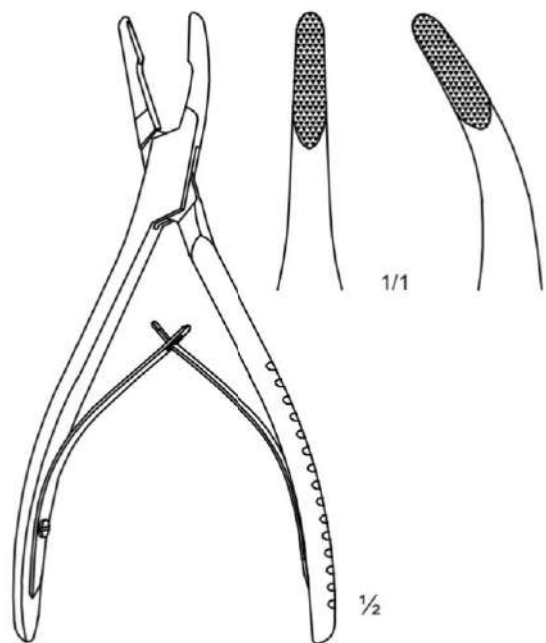

**JANSEN**

36-2401	Straight
36-2411	Curved



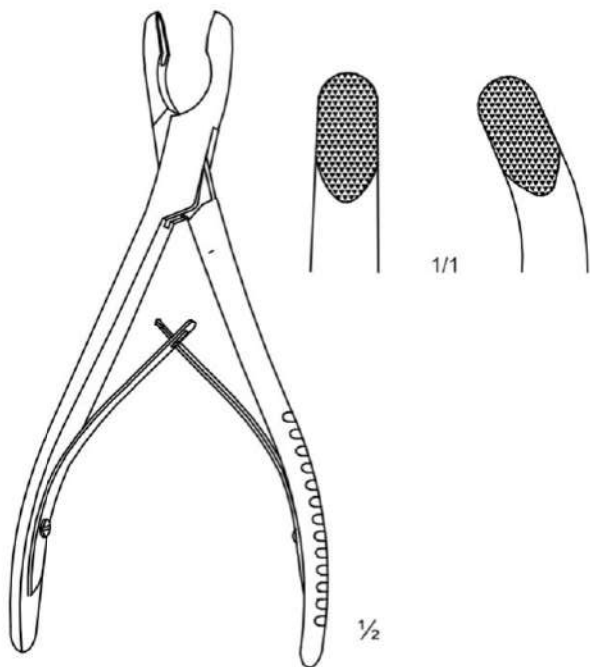

**LUER**

- 36-2501 Straight
- 36-2511 Curved

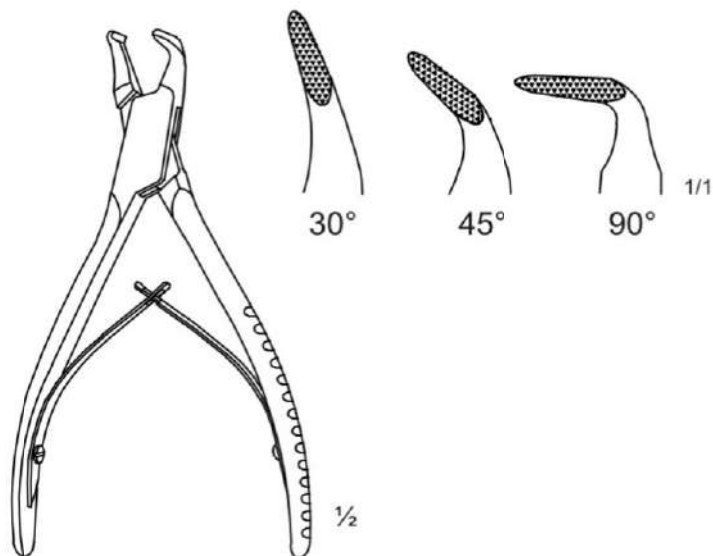

**BLUMENTHAL**

- 36-2601 Curved 30°
- 36-2602 Curved 45°
- 36-2603 Curved 90°

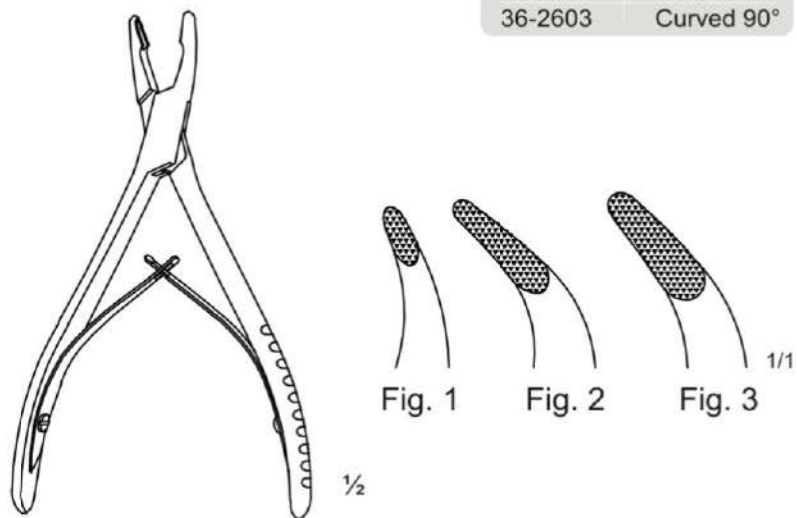

**LUER**

- 36-2701 Fig. 1
- 36-2702 Fig. 2
- 36-2703 Fig. 3



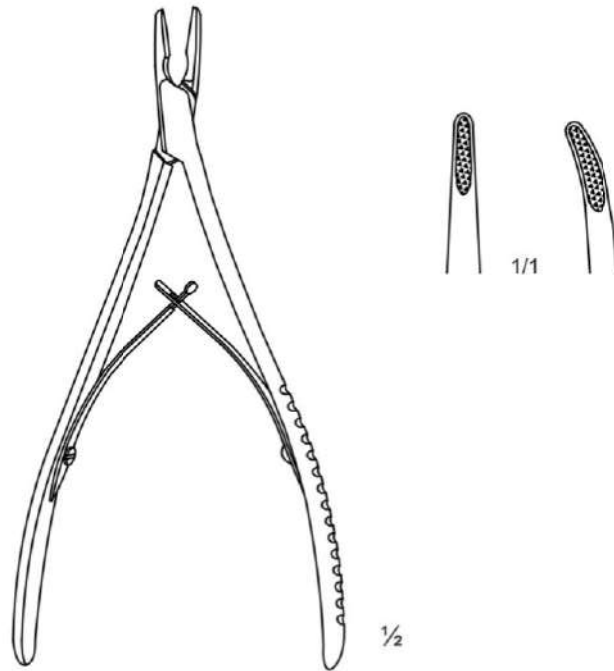

**LEMPERT**

- 36-2801 Straight
- 36-2811 Curved

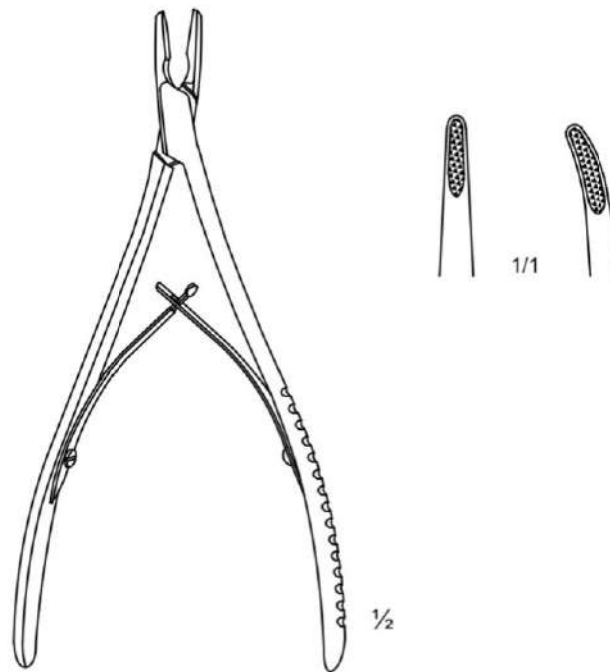

**LEMPERT**

- 36-2801 Straight
- 36-2811 Curved

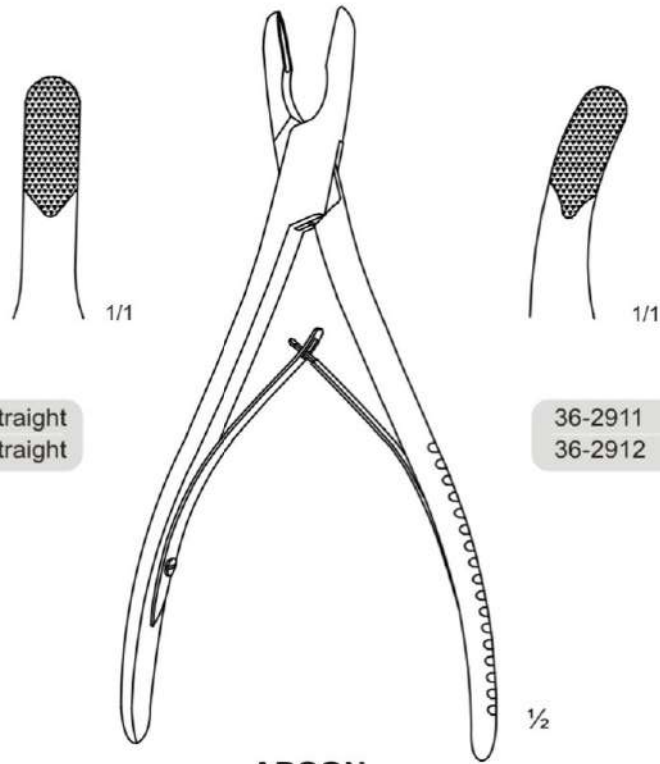

36-2901	7 x 16mm	Straight
36-2902	8 x 16mm	Straight

36-2911	7 x 16mm	Curved
36-2912	8 x 16mm	Curved

**ADSON**

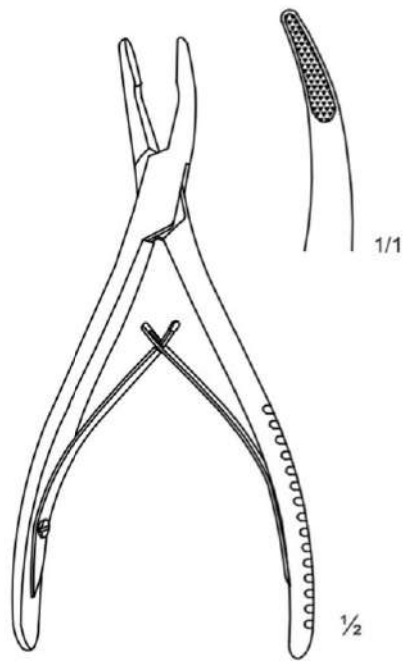

**BEYER**

36-3000	17.0cm
---------	--------

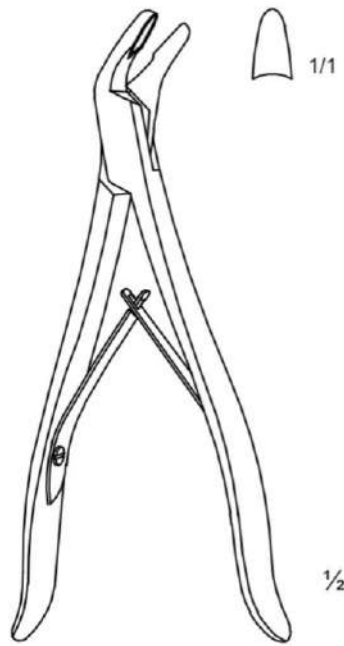

**BACON**  
angled jaw

▶ 36-3100 20.3cm

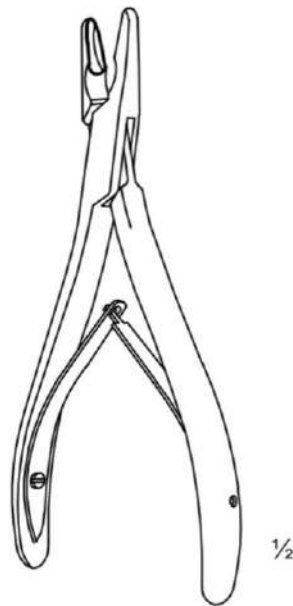

**CICHERELLI**

- ▶ 36-3201 Straight
- ▶ 36-3202 Slightly Curved
- ▶ 36-3203 Full Curved

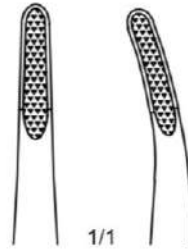
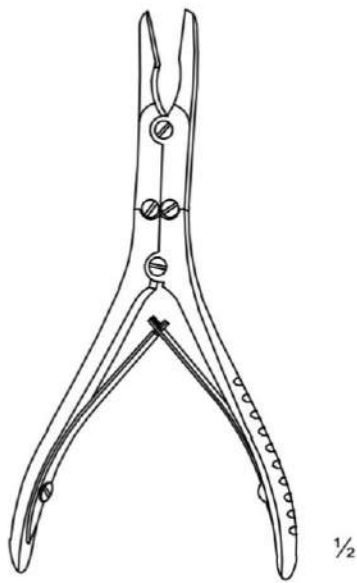

36-3301	3mm	Straight
36-3302	4mm	Straight
36-3303	5mm	Straight
36-3311	3mm	Curved
36-3312	4mm	Curved
36-3313	5mm	Curved

**BOHLER**

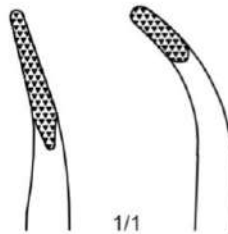
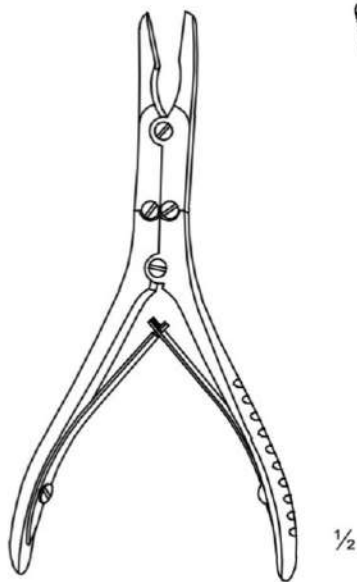

36-3401	2 x 13mm	Slightly Curved
36-3402	3 x 8mm	Full Curved

**KLEINERT-KUTZ**

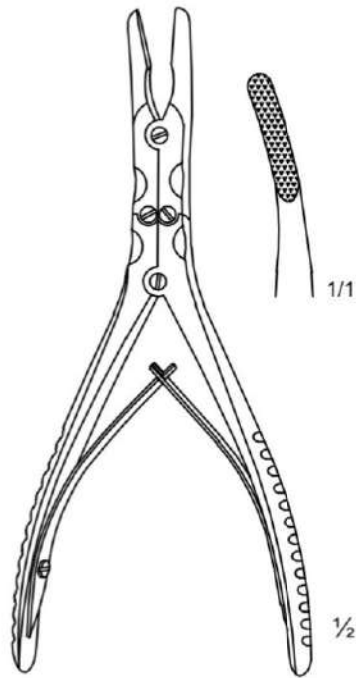

**BEYER**

36-3500 18.0cm

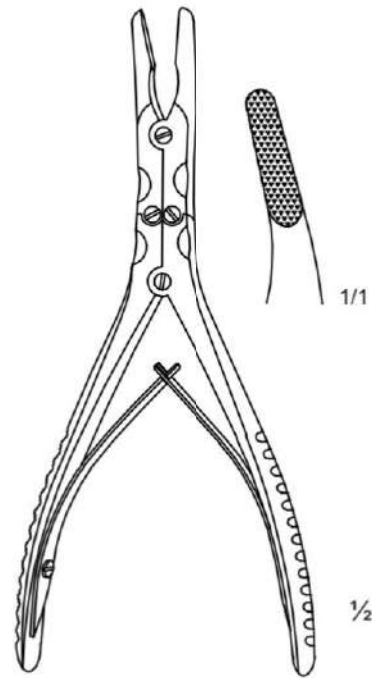

**ZAUFAL-JANSEN**

36-3600 18.0cm

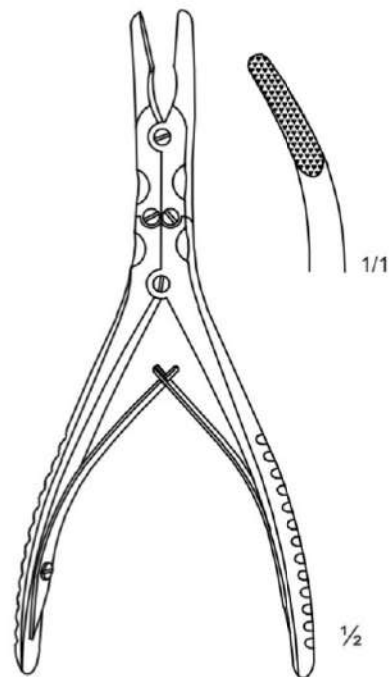

**MAYFIELD**

36-3700 17.0cm

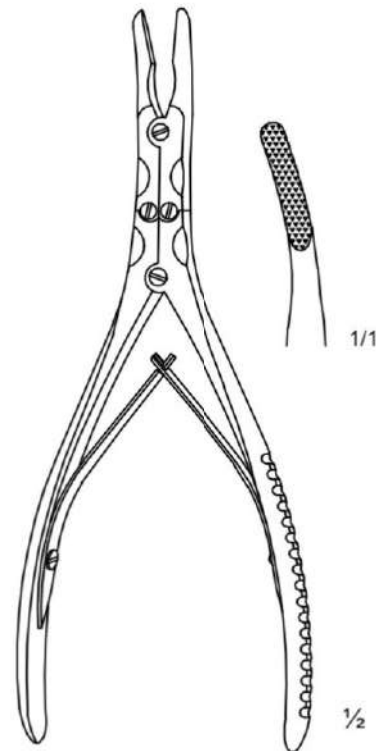

**MARQUARDT**

36-3800 20.0cm

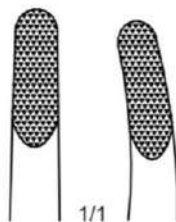
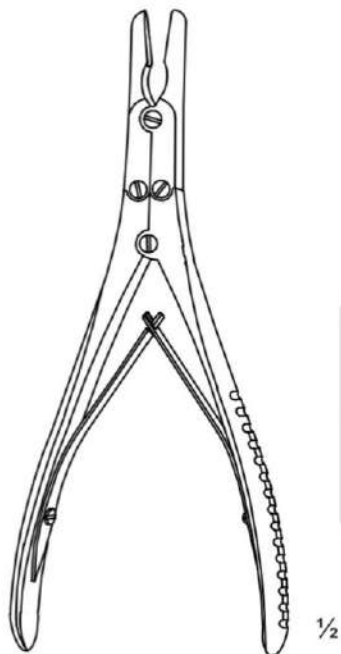

▶ 36-3901	4mm	Straight
▶ 36-3902	5mm	Straight
▶ 36-3903	6mm	Straight
▶ 36-3904	7mm	Straight
▶ 36-3911	4mm	Curved
▶ 36-3912	5mm	Curved
▶ 36-3913	6mm	Curved
▶ 36-3914	7mm	Curved

**RUSKIN**

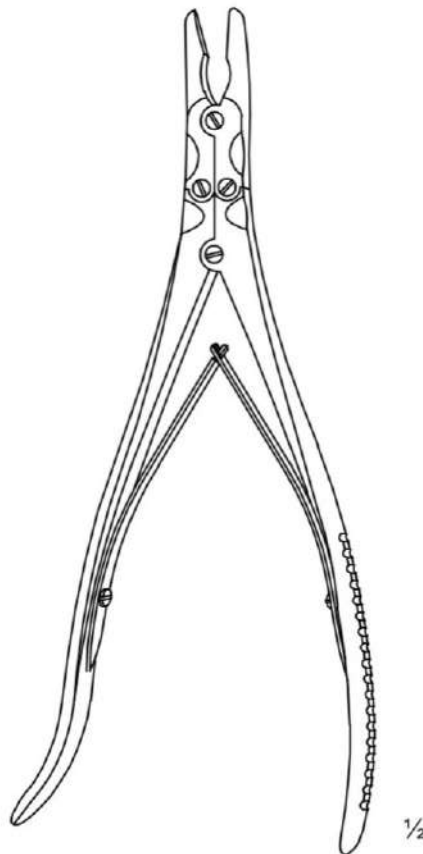
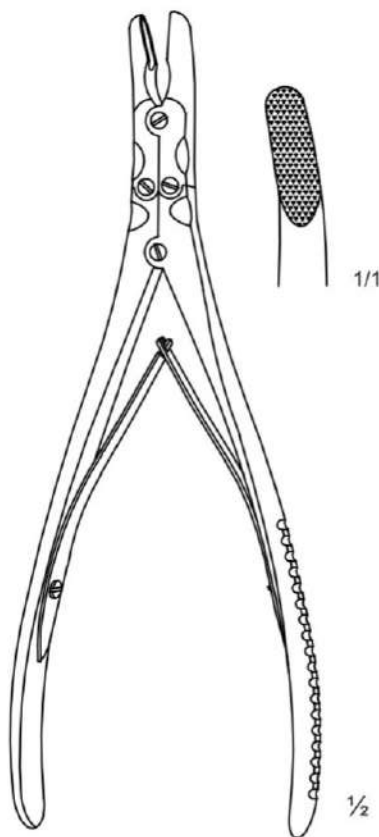

**RUSKIN**

36-3915	5mm	Curved
36-3916	6mm	Curved
36-3917	7mm	Curved

**SMITH-PETERSEN**

36-4001	Straight
36-4002	Slightly Curved
36-4003	Full Curved

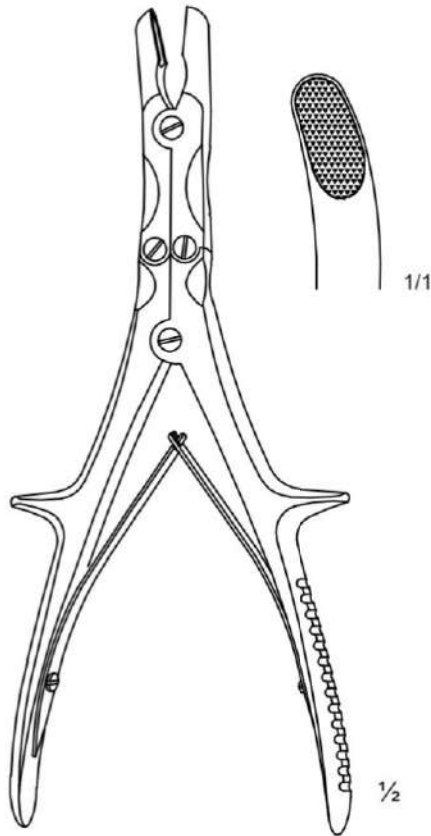

**STILLE-RUSKIN**

36-4100 23.0cm

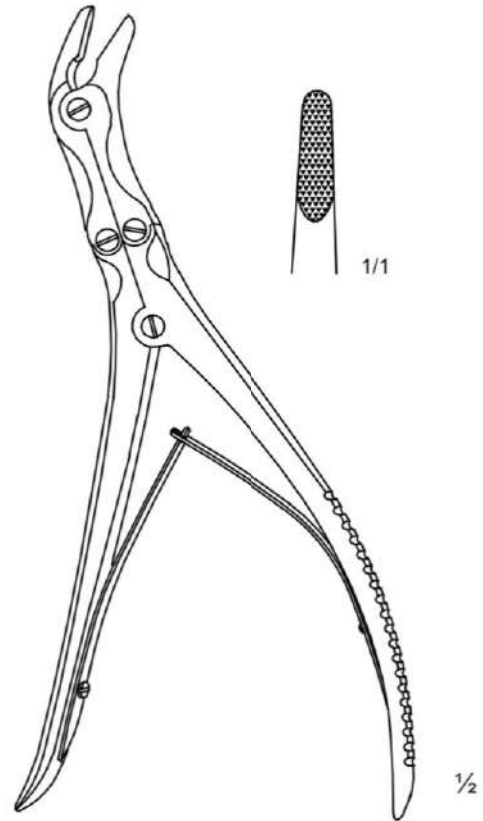

**FRYKHOLM**

36-4200 24.0cm

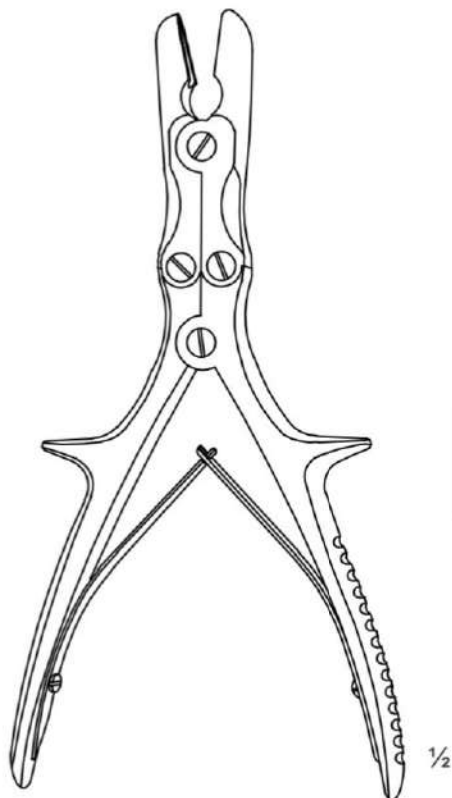

**STILLE-LUER**

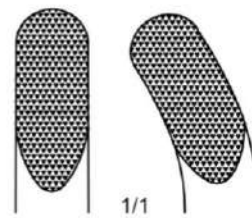

- ▶ 36-4301 22.0cm Straight
- ▶ 36-4302 26.0cm Straight
- ▶ 36-4311 22.0cm Curved
- ▶ 36-4312 26.0cm Curved



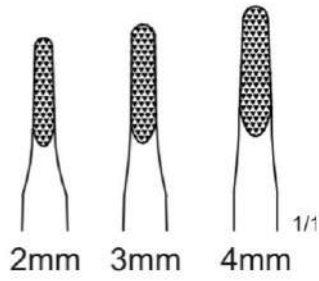
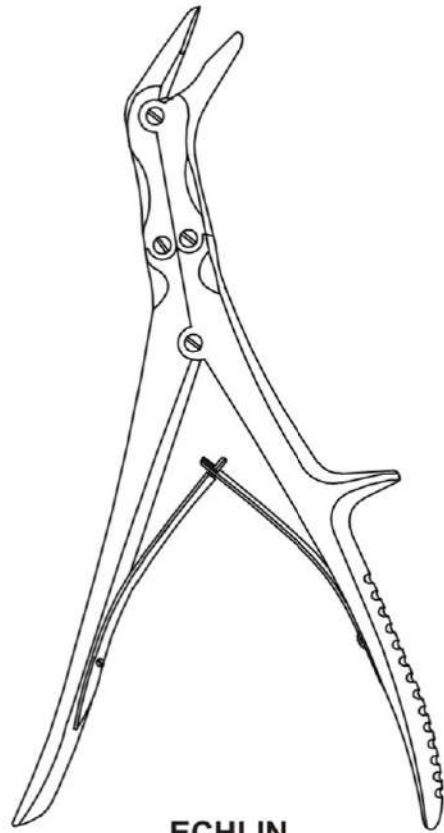

- ▶ 36-4401 2 x 10mm
- ▶ 36-4402 3 x 10mm
- ▶ 36-4403 4 x 10mm

**ECHLIN**

1/2

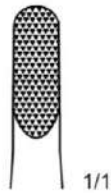
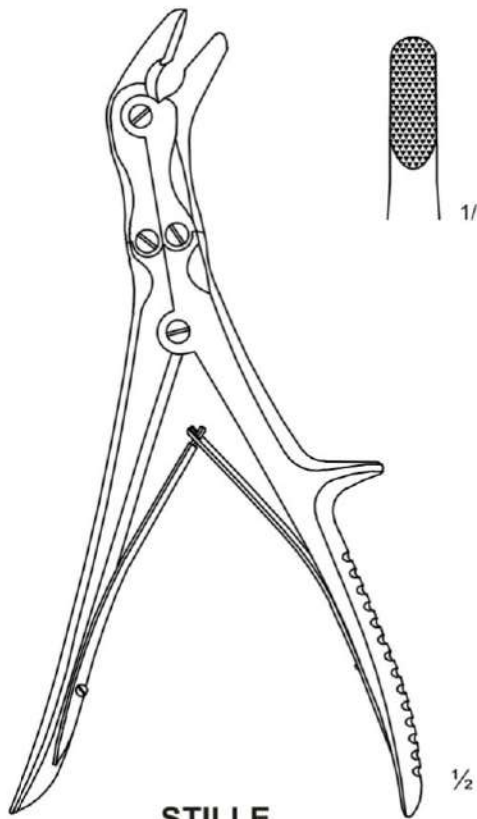

**STILLE**

- ▶ 36-4501 5 x 14mm
- ▶ 36-4502 6 x 14mm

1/2

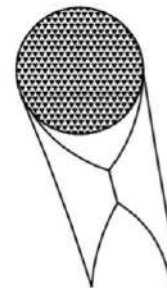
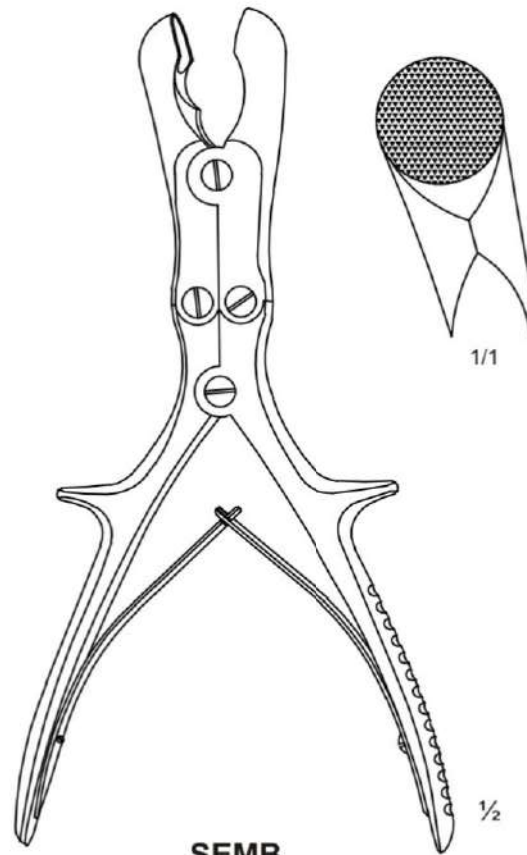

**SEMB**

- 36-4600 31.0cm

1/2

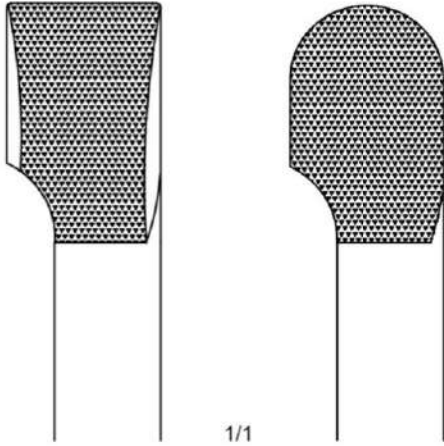

1/1

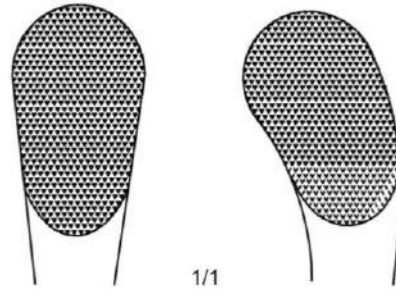

1/1

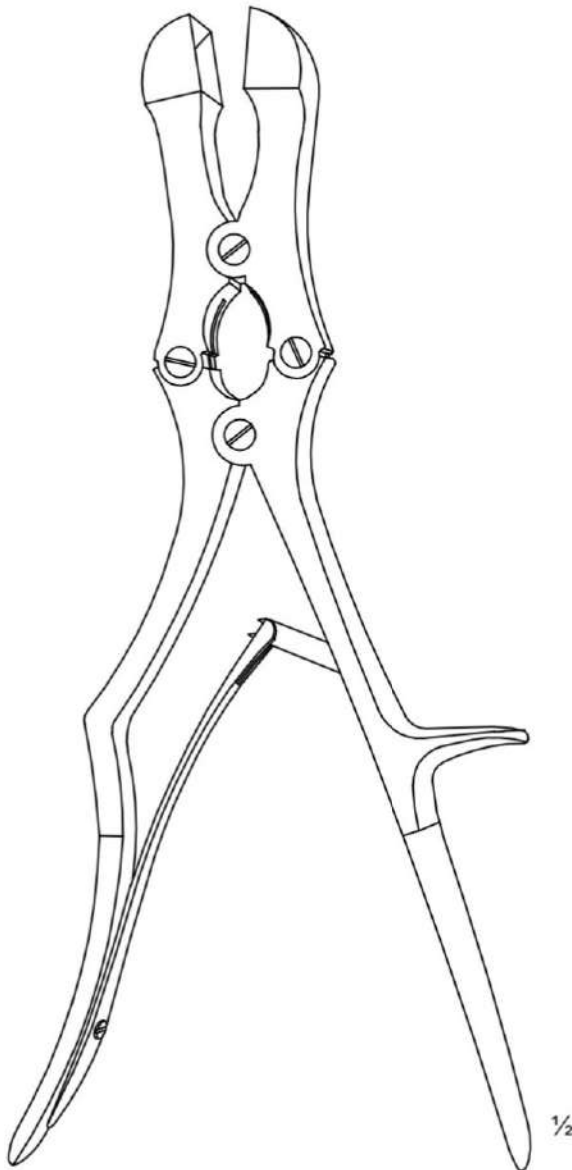

1/2

**SAUERBRUCH**

36-4701	Square
36-4702	Round

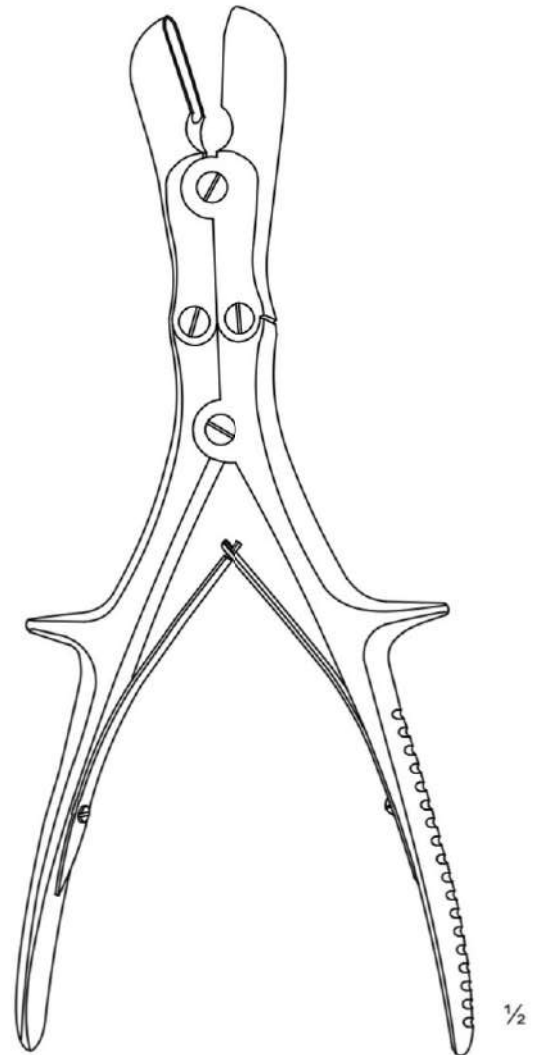

1/2

**STILLE-LUER**

36-4303	22.0cm	Straight
36-4304	27.0cm	Straight
36-4313	22.0cm	Curved
36-4314	27.0cm	Curved



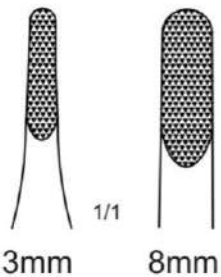
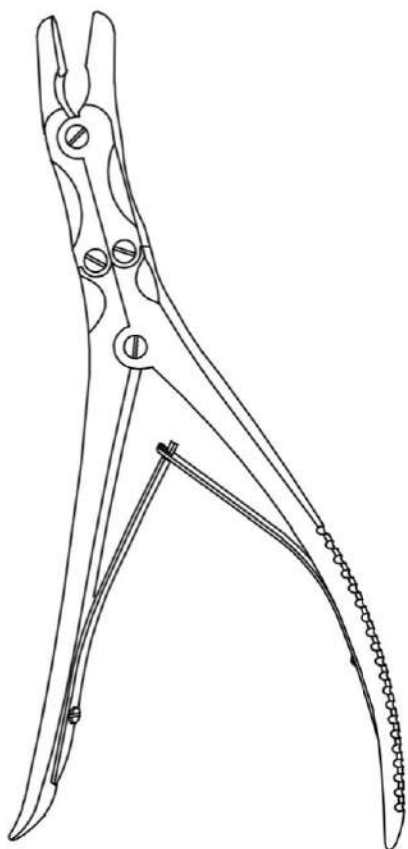

36-4801	3mm
36-4802	4mm
36-4803	5mm
36-4804	6mm
36-4805	7mm
36-4806	8mm

**LEKSELL-STILLE**  
Slightly Curved

1/2

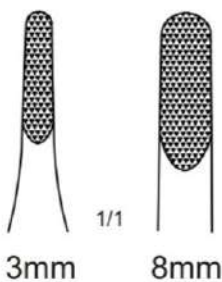

36-4811	3mm
36-4812	4mm
36-4813	5mm
36-4814	6mm
36-4815	7mm
36-4816	8mm

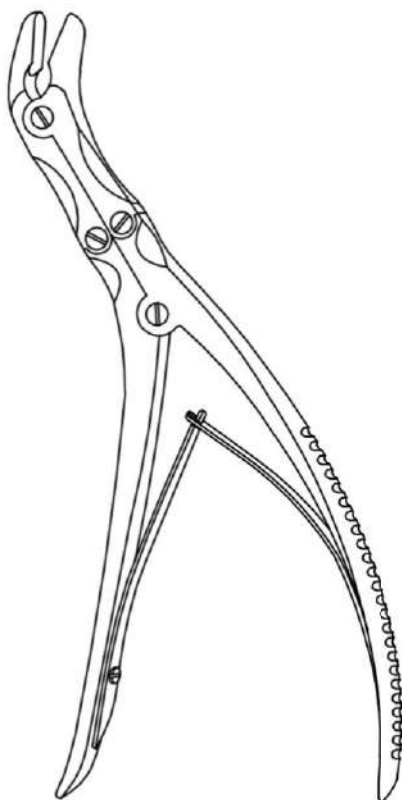

**LEKSELL-STILLE**  
Full Curved

1/2

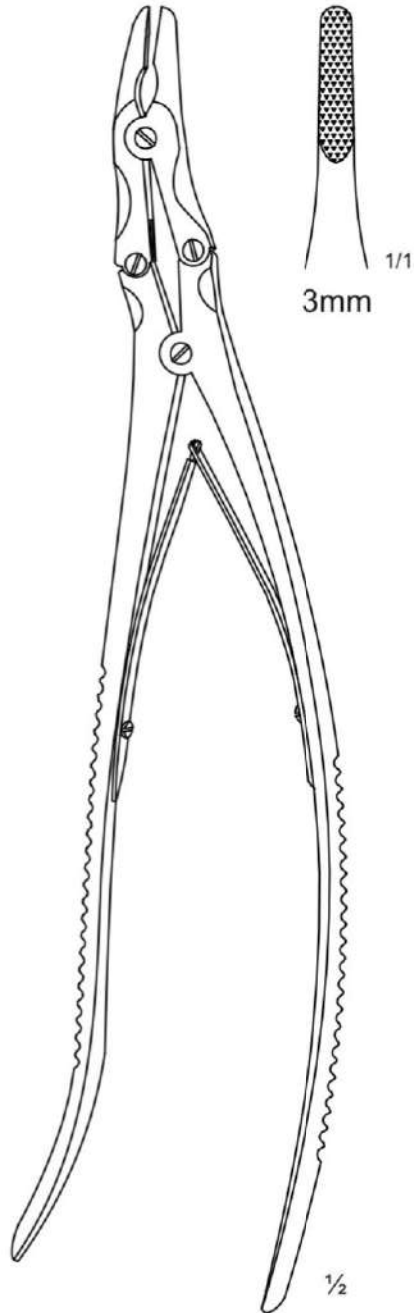

**DALE**

36-4901	3mm
36-4902	8mm

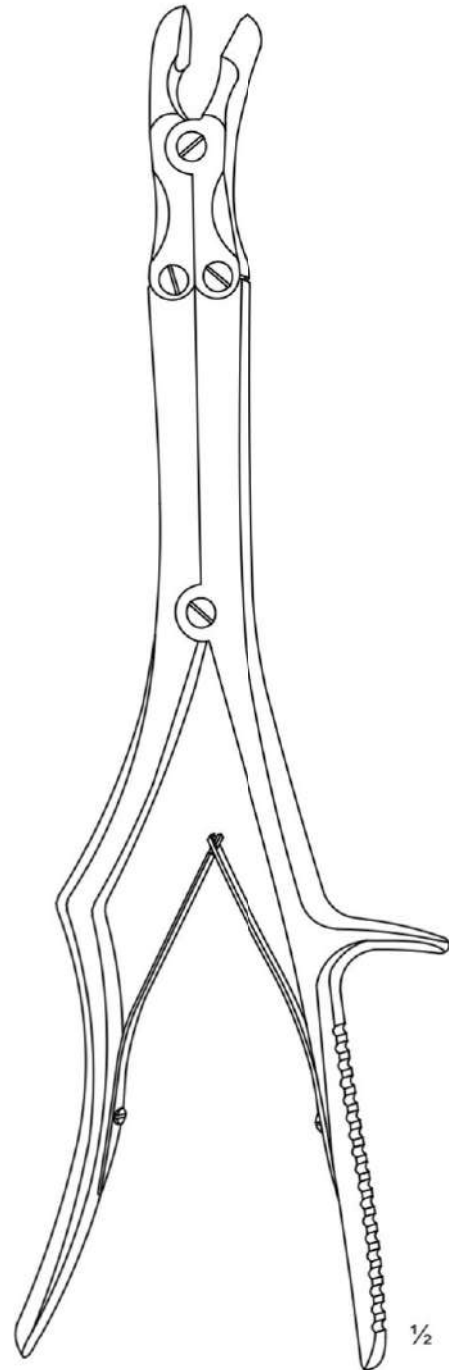

**SYPERT**

36-5001	4mm
36-5002	5mm
36-5003	8mm
36-5004	12mm

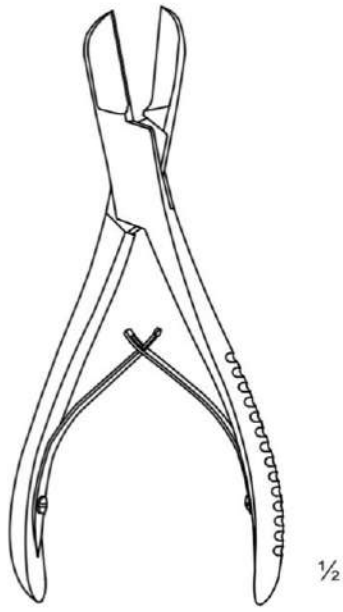

**LISTON**

36-5101	14.0cm	Straight
▶ 36-5102	17.0cm	Straight
36-5103	19.0cm	Straight
36-5104	22.0cm	Straight
36-5111	14.0cm	Curved
36-5112	17.0cm	Curved
36-5113	19.0cm	Curved
36-5114	22.0cm	Curved

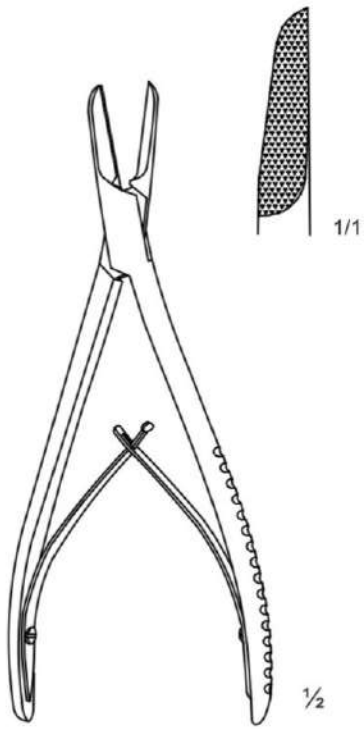

**COTTLE KAZANJIAN**

36-5200 19.0cm

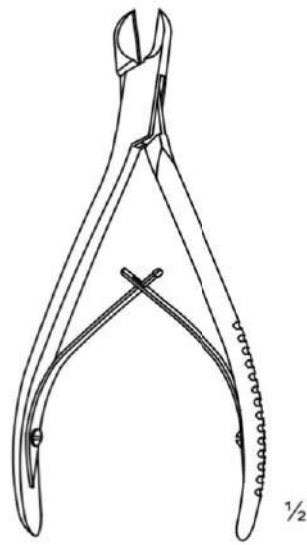

**LITTAUER**

36-5300 15.0cm

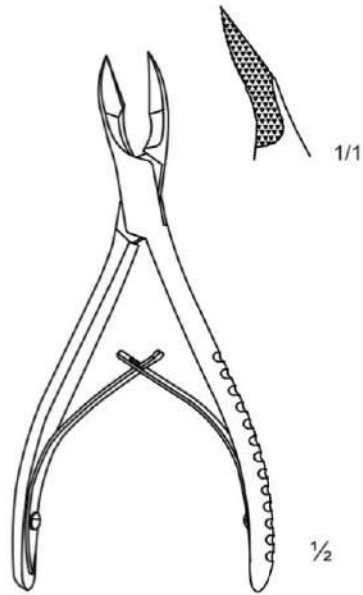

**CLEVELAND**

36-5401 | 15.0cm

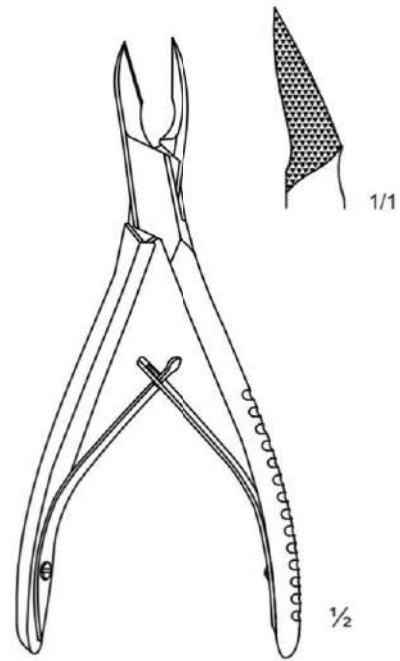

**CLEVELAND**

36-5402 | 17.0cm

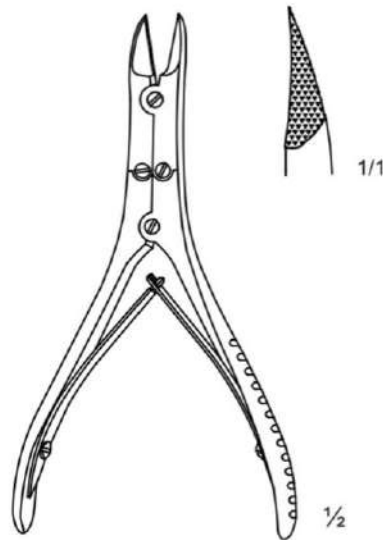

**BOHLER**

36-5501 | Straight  
36-5511 | Curved



# Bone Cutting Forceps

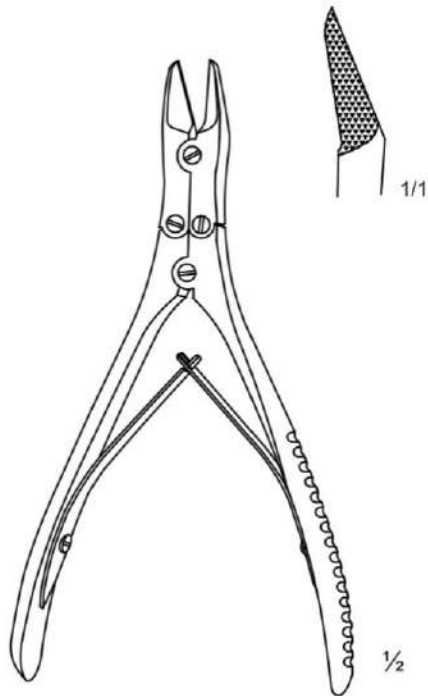

**MC INDOE**

36-5600 17.5cm

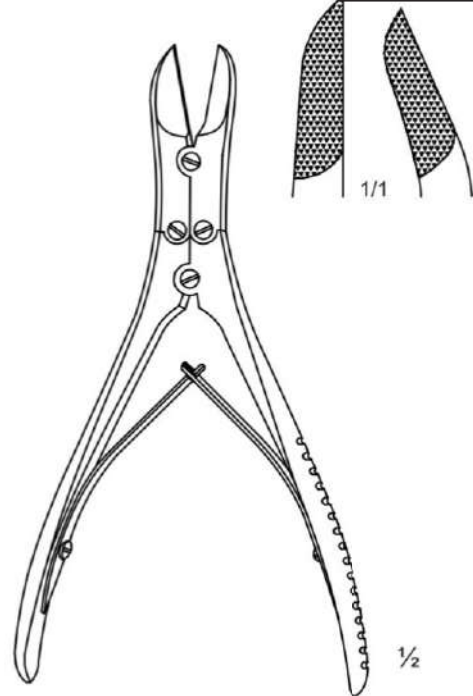

**RUSKIN-LISTON**

▶ 36-5701 Straight  
36-5711 Curved

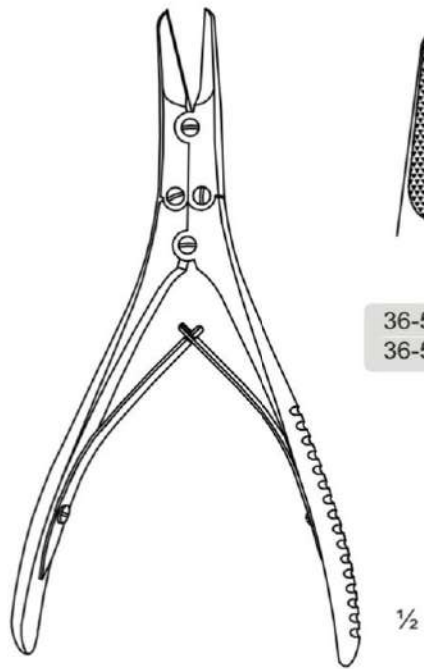

**RUSKIN-ROWLAND**

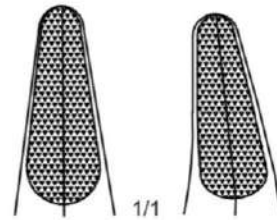

36-5801 Straight  
36-5811 Angled to side



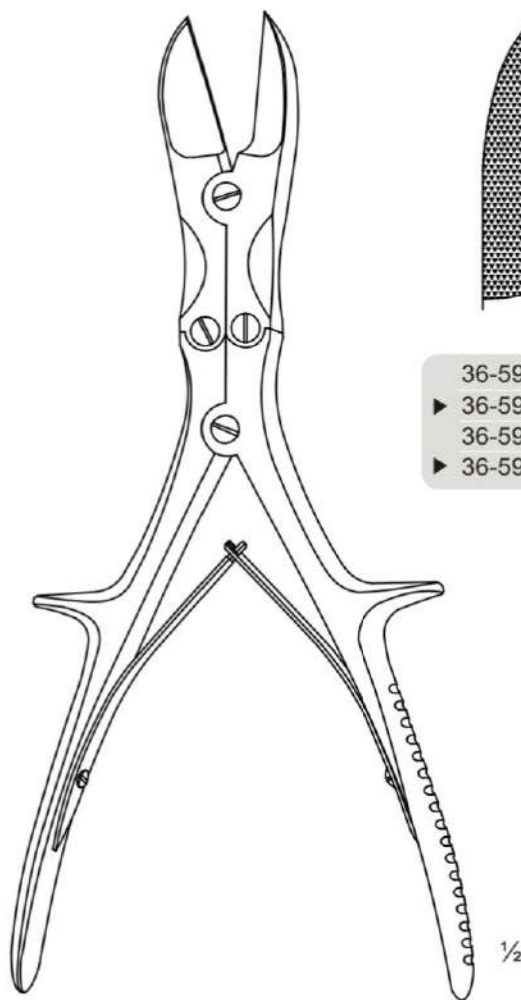

**STILLE-LISTON**

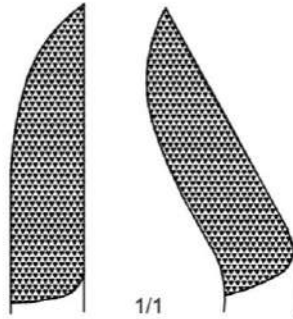

36-5901	23.0cm	Straight
▶ 36-5902	27.0cm	Straight
36-5911	23.0cm	Curved
▶ 36-5912	27.0cm	Curved

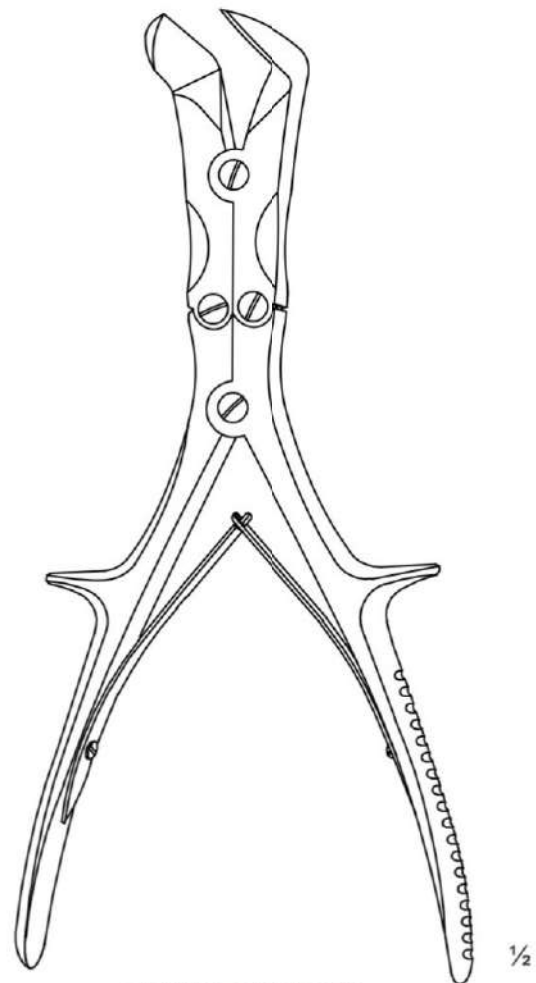
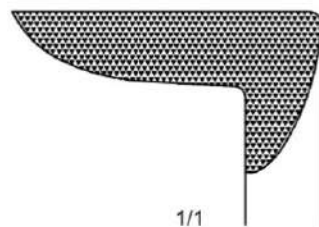

**STILLE-LISTON**

36-6000 | 27.0cm

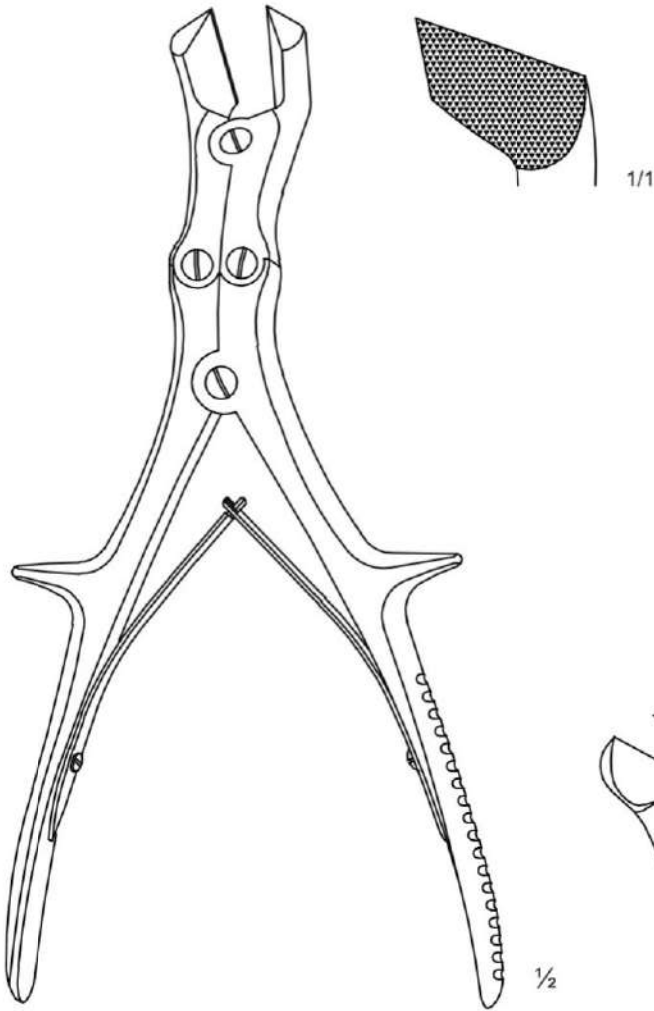

**LISTON-KEY**

36-6100 27.0cm

1/2

1/2

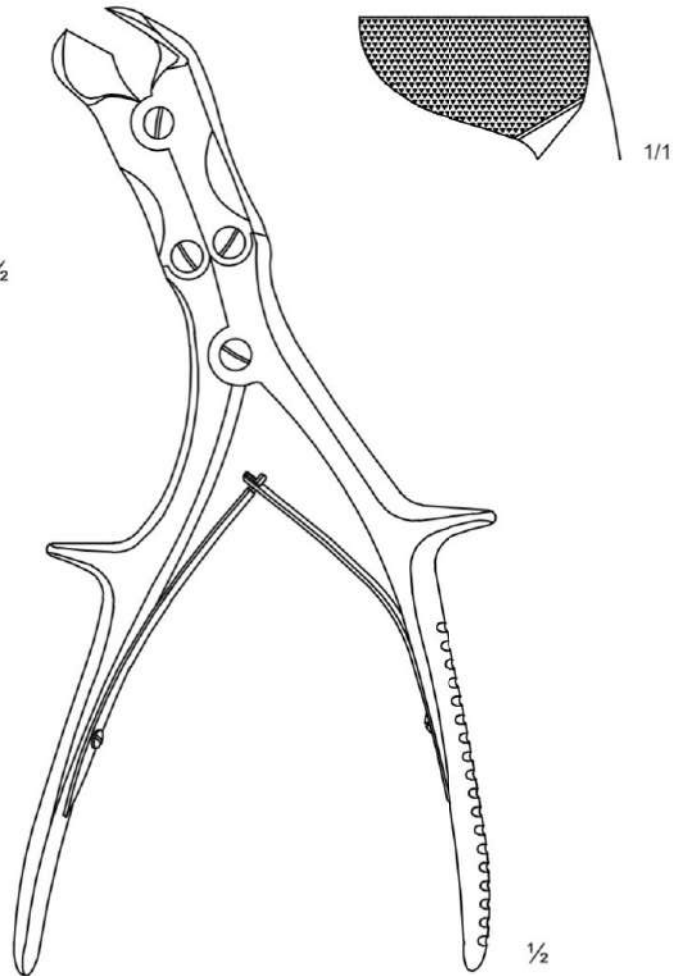

**SEMB**

36-6200 24.0cm

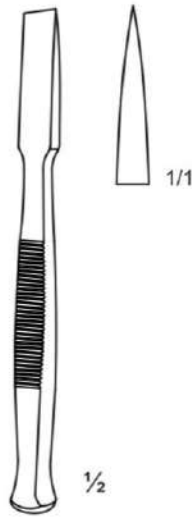

### Osteotomes

36-6301	4mm
36-6302	6mm
36-6303	8mm
36-6304	10mm
36-6305	12mm

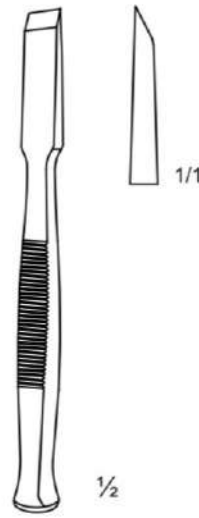

### Gouges

36-6321	4mm
36-6322	6mm
36-6323	8mm
36-6324	10mm
36-6325	12mm

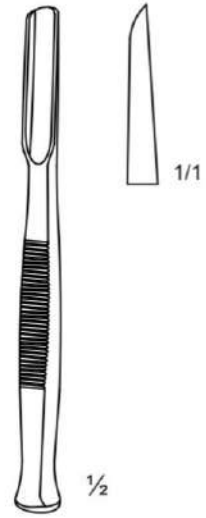

### Chisels

36-6331	4mm
36-6332	6mm
36-6333	8mm
36-6334	10mm
36-6335	12mm

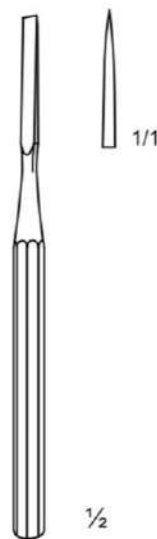

### HOKE Osteotomes

36-6401	2mm
▶ 36-6402	3mm
36-6403	4mm
▶ 36-6404	5mm
▶ 36-6405	6mm
36-6406	7mm
▶ 36-6407	8mm

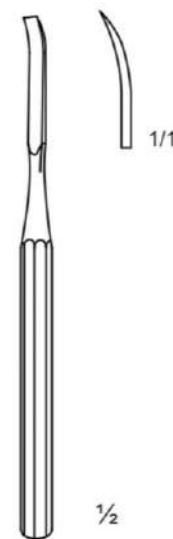

### HOKE Osteotomes

36-6411	2mm
▶ 36-6412	3mm
36-6413	4mm
▶ 36-6414	5mm
▶ 36-6415	6mm
36-6416	7mm
▶ 36-6417	8mm



### Round Handle

36-6500	14.0cm	6mm
---------	--------	-----

# Osteotomes

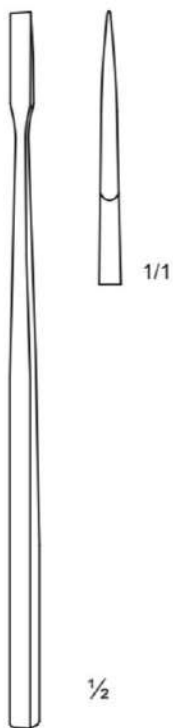

**WEST**  
Chisel

36-6601 19.0cm

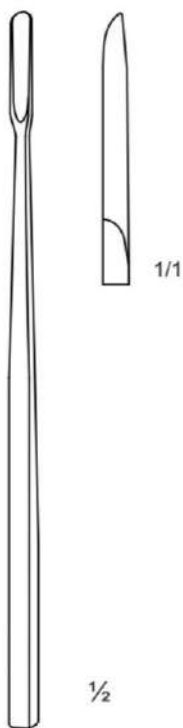

**WEST**  
Gouge

36-6621 19.0cm

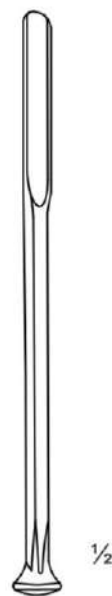

**ANDREWS**

36-6701	4mm
▶ 36-6702	6mm
▶ 36-6703	8mm
36-6704	10mm
36-6705	12mm

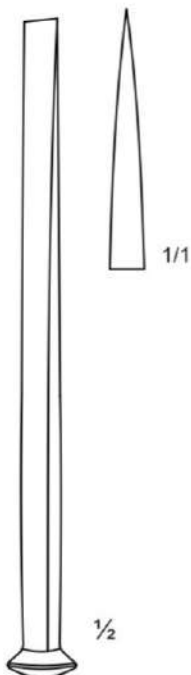

**ALEXANDER**  
Osteotomes

36-6801	4mm
▶ 36-6802	6mm
36-6803	8mm
36-6804	10mm
▶ 36-6805	12mm
36-6806	14mm

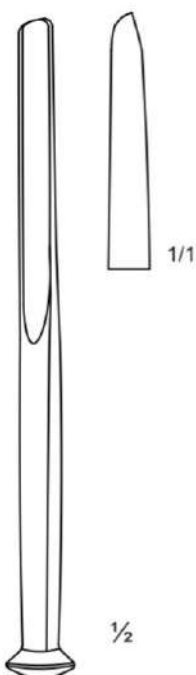

**ALEXANDER**  
Gouge

36-6821	4mm
▶ 36-6822	6mm
36-6823	8mm
▶ 36-6824	10mm
36-6825	12mm
36-6826	14mm

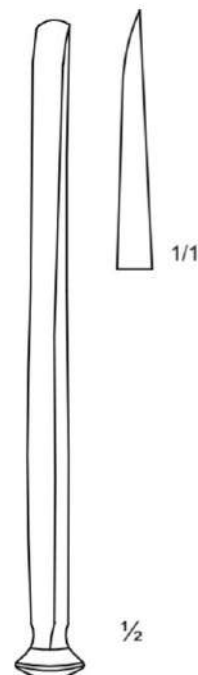

**ALEXANDER**  
Chisels

36-6831	4mm
▶ 36-6832	6mm
36-6833	8mm
36-6834	10mm
▶ 36-6835	12mm
36-6836	14mm

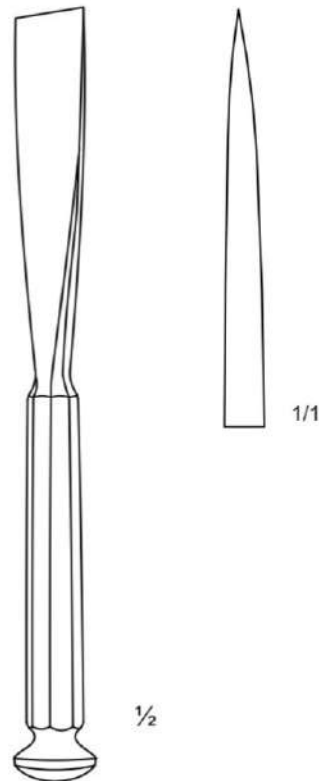

**STILLE**  
Osteotomes

36-6901	20.0cm	10mm	Straight
36-6902	20.0cm	12mm	Straight
36-6903	20.0cm	15mm	Straight
36-6904	20.0cm	20mm	Straight
36-6905	20.0cm	25mm	Straight
36-6940	23.0cm	4mm	Straight
36-6941	23.0cm	6mm	Straight
36-6942	23.0cm	8mm	Straight
36-6943	23.0cm	10mm	Straight
36-6944	23.0cm	12mm	Straight
36-6945	23.0cm	15mm	Straight
36-6946	23.0cm	20mm	Straight
36-6947	23.0cm	25mm	Straight
36-6948	23.0cm	30mm	Straight
36-6949	23.0cm	40mm	Straight

36-6911	20.0cm	10mm	Curved
36-6912	20.0cm	12mm	Curved
36-6913	20.0cm	15mm	Curved
36-6914	20.0cm	20mm	Curved
36-6915	20.0cm	25mm	Curved

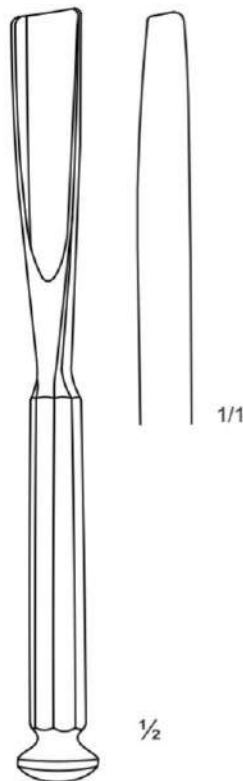

**STILLE**  
Gouges

36-6921	20.0cm	10mm	Straight
36-6922	20.0cm	12mm	Straight
36-6923	20.0cm	15mm	Straight
36-6924	20.0cm	20mm	Straight
36-6925	20.0cm	25mm	Straight
36-6950	23.0cm	4mm	Straight
36-6951	23.0cm	6mm	Straight
36-6952	23.0cm	8mm	Straight
36-6953	23.0cm	10mm	Straight
36-6954	23.0cm	12mm	Straight
36-6955	23.0cm	15mm	Straight
36-6956	23.0cm	20mm	Straight
36-6957	23.0cm	25mm	Straight
36-6958	23.0cm	30mm	Straight
36-6959	23.0cm	40mm	Straight

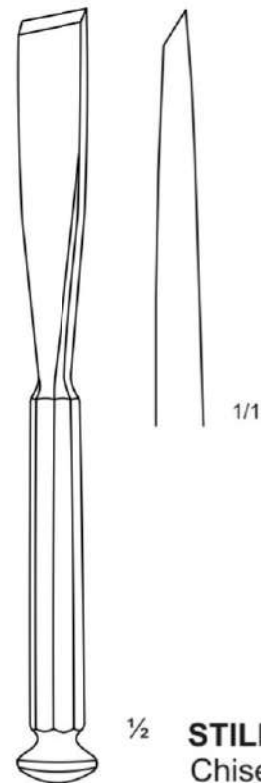

**STILLE**  
Chisels

36-6931	20.0cm	10mm	Straight
36-6932	20.0cm	12mm	Straight
36-6933	20.0cm	15mm	Straight
36-6934	20.0cm	20mm	Straight
36-6935	20.0cm	25mm	Straight



# Osteotomes

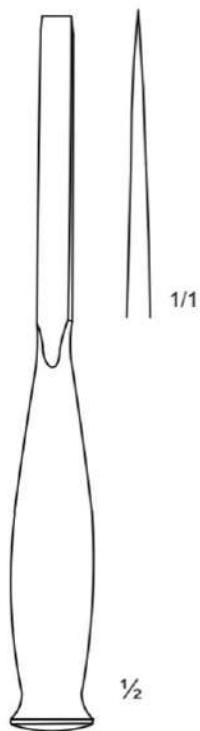

**SMITH-PETERSEN**

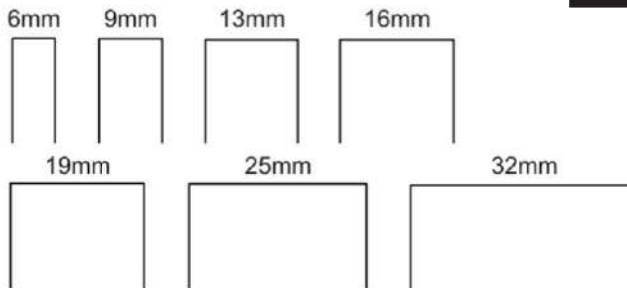

**ARTIFICIAL WOOD HANDLE**

Please Add the Symbol "W" to the Artical Numbers

▶ 36-7001	6mm	Straight
▶ 36-7002	9mm	Straight
▶ 36-7003	13mm	Straight
▶ 36-7004	16mm	Straight
▶ 36-7005	19mm	Straight
▶ 36-7006	25mm	Straight
▶ 36-7007	32mm	Straight

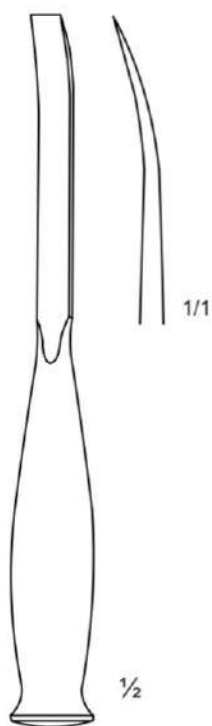

**SMITH-PETERSEN**

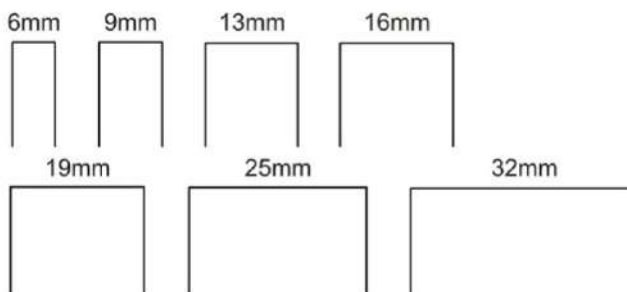

**ARTIFICIAL WOOD HANDLE**

Please Add the Symbol "W" to the Artical Numbers

▶ 36-7011	6mm	Curved
▶ 36-7012	9mm	Curved
▶ 36-7013	13mm	Curved
▶ 36-7014	16mm	Curved
▶ 36-7015	19mm	Curved
▶ 36-7016	25mm	Curved
▶ 36-7017	32mm	Curved

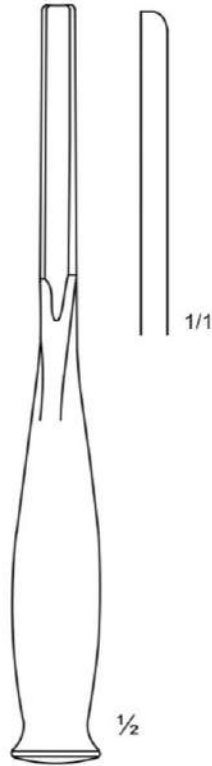

SMITH-PETERSEN

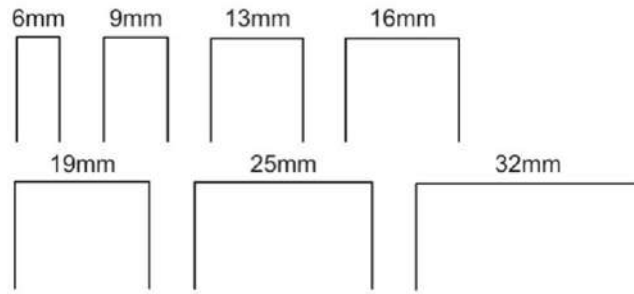

ARTIFICIAL WOOD HANDLE

Please Add the Symbol "W" to the Artical Numbers

▶ 36-7021	6mm	Straight
▶ 36-7022	9mm	Straight
▶ 36-7023	13mm	Straight
▶ 36-7024	16mm	Straight
▶ 36-7025	19mm	Straight
▶ 36-7026	25mm	Straight
▶ 36-7027	32mm	Straight

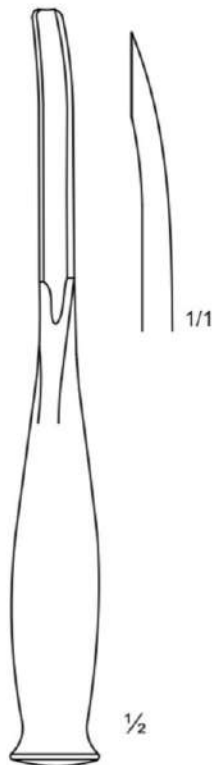

SMITH-PETERSEN

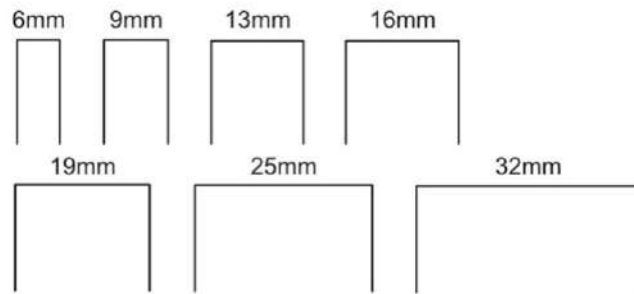

ARTIFICIAL WOOD HANDLE

Please Add the Symbol "W" to the Artical Numbers

36-7031	6mm	Curved
36-7032	9mm	Curved
36-7033	13mm	Curved
36-7034	16mm	Curved
36-7035	19mm	Curved
36-7036	25mm	Curved
36-7037	32mm	Curved



# Osteotomes



**CODMAN**

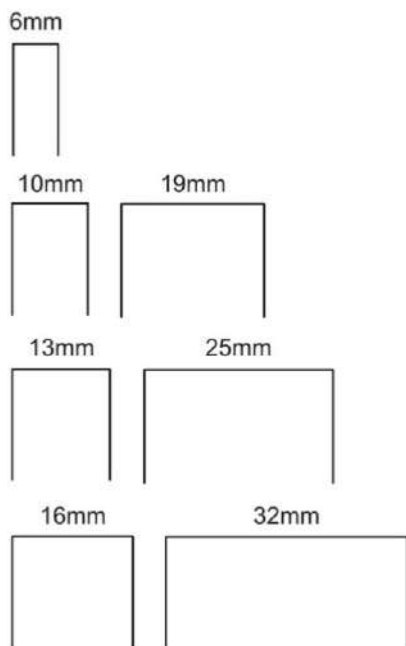

36-7101	6mm	Straight
36-7102	10mm	Straight
36-7103	13mm	Straight
36-7104	16mm	Straight
36-7105	19mm	Straight
36-7106	25mm	Straight
36-7107	32mm	Straight
36-7111	6mm	Curved
36-7112	10mm	Curved
36-7113	13mm	Curved
36-7114	16mm	Curved
36-7115	19mm	Curved
36-7116	25mm	Curved
36-7117	32mm	Curved



**CODMAN**  
Gouges

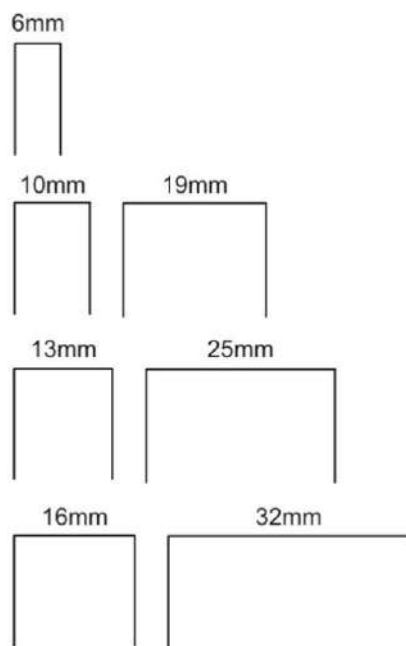

36-7121	6mm	Straight
36-7122	10mm	Straight
36-7123	13mm	Straight
36-7124	16mm	Straight
36-7125	19mm	Straight
36-7126	25mm	Straight
36-7127	32mm	Straight
36-7131	6mm	Curved
36-7132	10mm	Curved
36-7133	13mm	Curved
36-7134	16mm	Curved
36-7135	19mm	Curved
36-7136	25mm	Curved
36-7137	32mm	Curved



36-7201	4mm	Straight
▶ 36-7202	6mm	Straight
36-7203	8mm	Straight
36-7204	10mm	Straight
▶ 36-7205	13mm	Straight
36-7206	15mm	Straight
36-7207	18mm	Straight
▶ 36-7208	20mm	Straight
▶ 36-7209	25mm	Straight
36-7210	30mm	Straight
36-7211	38mm	Straight
36-7212	44mm	Straight
36-7213	50mm	Straight

**LAMBOTTE**

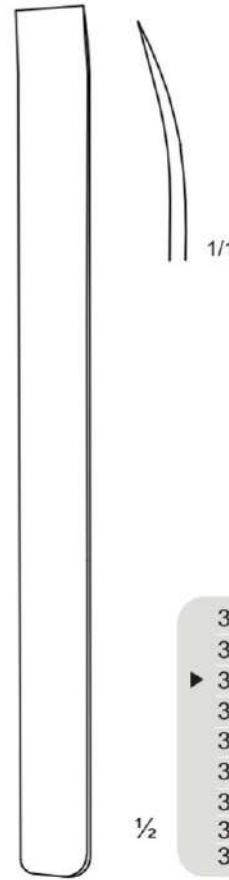

36-7221	6mm	Curved
36-7222	8mm	Curved
▶ 36-7223	13mm	Curved
36-7224	15mm	Curved
36-7225	18mm	Curved
36-7226	20mm	Curved
36-7227	25mm	Curved
36-7228	30mm	Curved
36-7229	38mm	Curved

**LAMBOTTE**

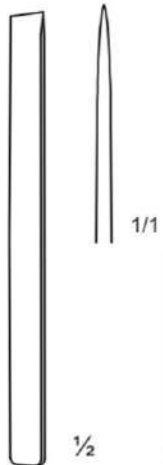

36-7231	2mm	Straight
▶ 36-7232	4mm	Straight
▶ 36-7233	6mm	Straight
▶ 36-7234	8mm	Straight
▶ 36-7235	10mm	Straight
▶ 36-7236	12mm	Straight
36-7237	15mm	Straight

**MINI-LAMBOTTE**



36-7241	4mm
36-7242	8mm

**Chisels**

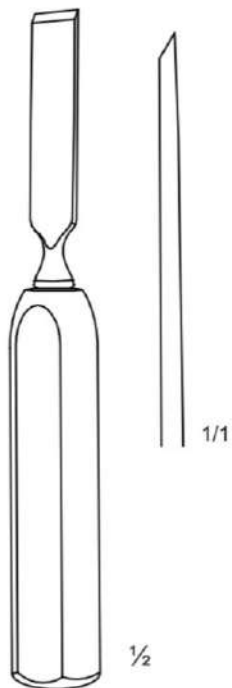

**FLACHMEISSEL**  
with artificial wood handle

36-7301	10mm	Straight
36-7302	15mm	Straight
36-7303	20mm	Straight

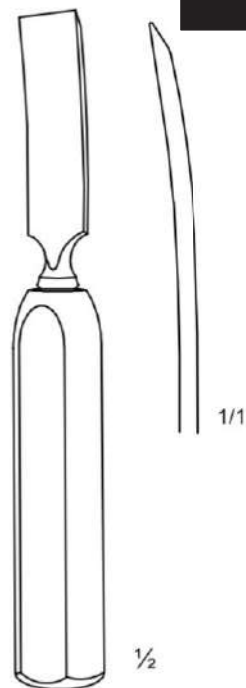

**FLACHMEISSEL**  
with artificial wood handle

36-7311	10mm	Curved
36-7312	15mm	Curved
36-7313	20mm	Curved

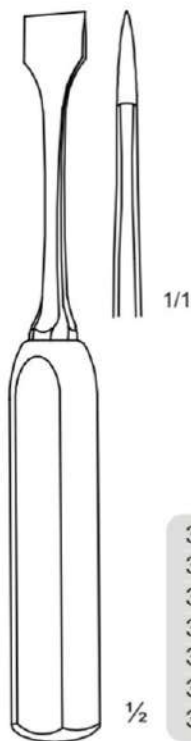

**LEXER**  
Osteotomes  
with artificial wood handle

36-7321	5mm	Straight
36-7322	7mm	Straight
36-7323	10mm	Straight
36-7324	15mm	Straight
36-7325	20mm	Straight
36-7326	25mm	Straight
36-7327	30mm	Straight

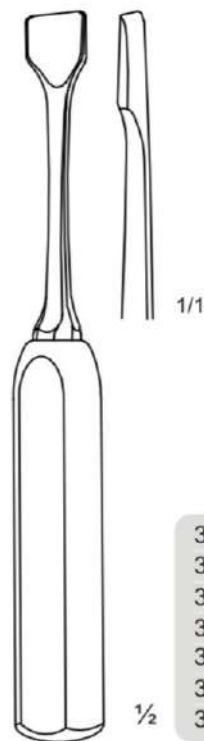

**LEXER**  
Gouges  
with artificial wood handle

36-7331	5mm	Straight
36-7332	7mm	Straight
36-7333	10mm	Straight
36-7334	15mm	Straight
36-7335	20mm	Straight
36-7336	25mm	Straight
36-7337	30mm	Straight

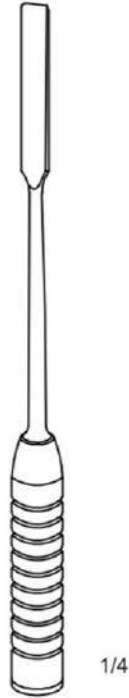

**LONG**

- ▶ 36-7401 6.5mm
- ▶ 36-7402 9.5mm
- ▶ 36-7403 13.5mm

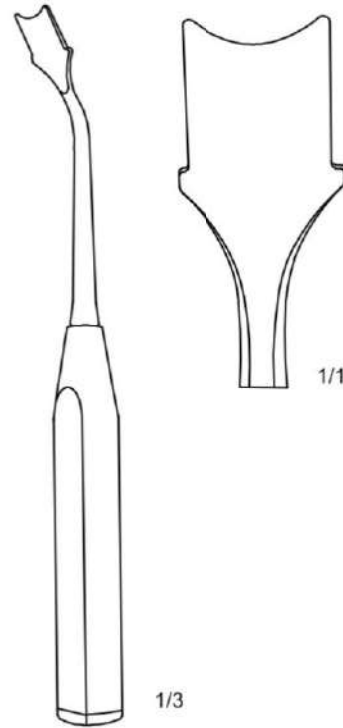

**PELVIC**

with artificial wood handle

- ▶ 36-7501 14mm
- ▶ 36-7502 20mm

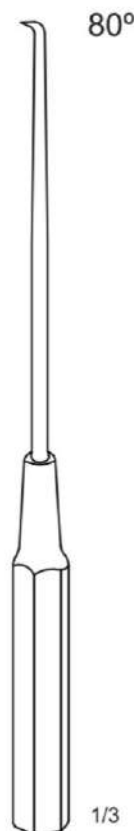
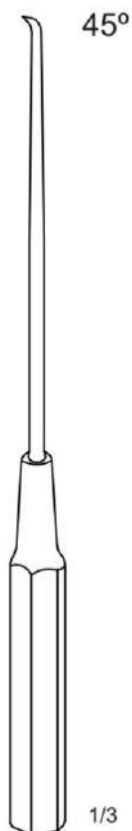
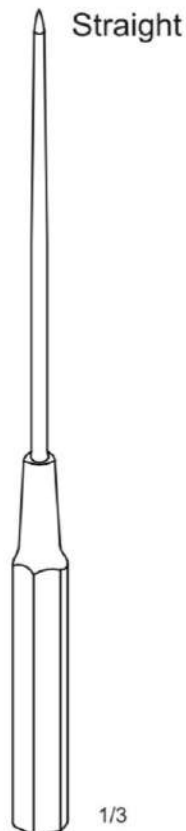

**AWL**

- ▶ 36-7601 Straight
- ▶ 36-7611 45°
- ▶ 36-7612 80°

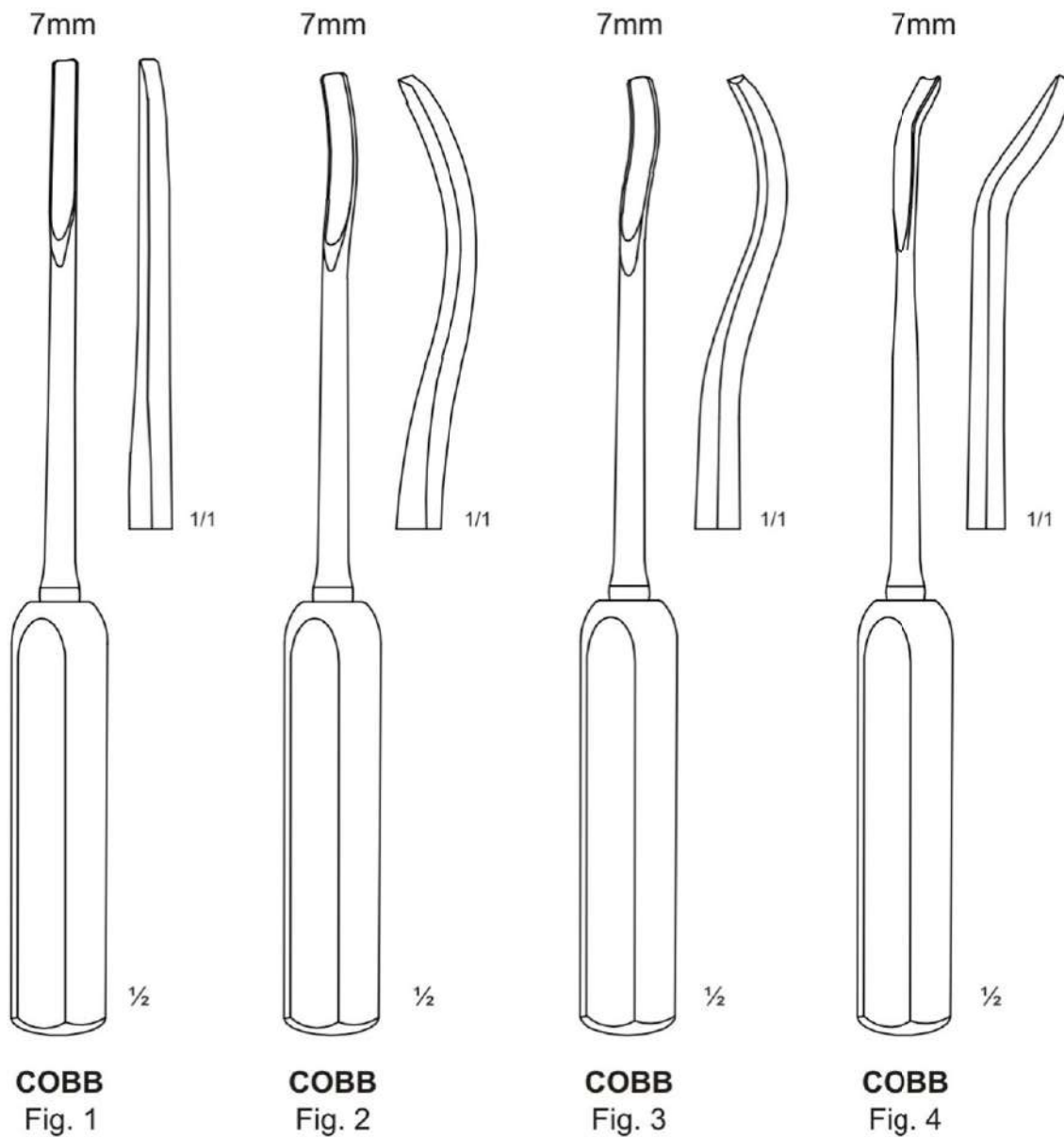

with artificial wood handle

▶ 36-7701	Straight	Fig. 1
▶ 36-7702	Light curved	Fig. 2
▶ 36-7703	Strong curved	Fig. 3
▶ 36-7704	Curved backwards	Fig. 4

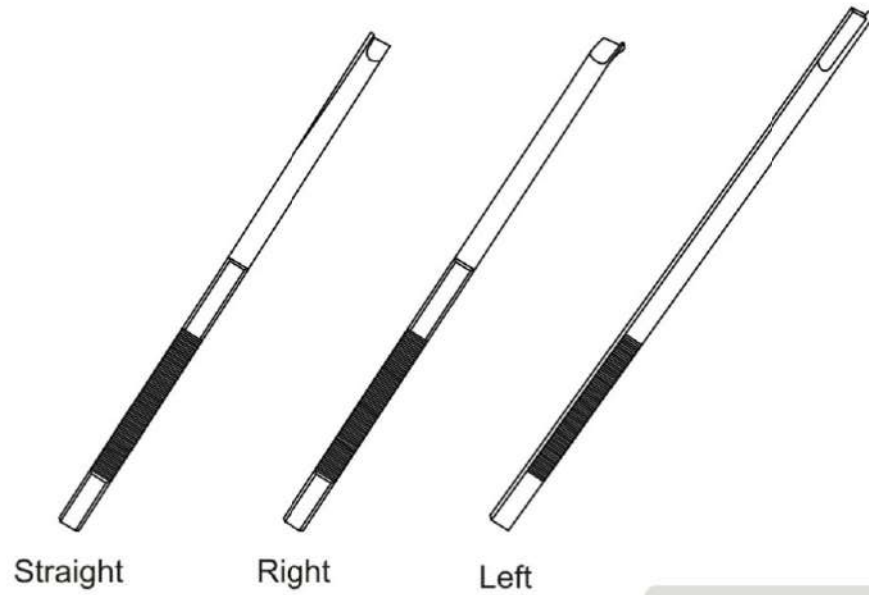

Straight

Right

Left

- ▶ 36-7801 Straight
- ▶ 36-7802 Right
- ▶ 36-7803 Left

**ANDERSON-NEIVERT**

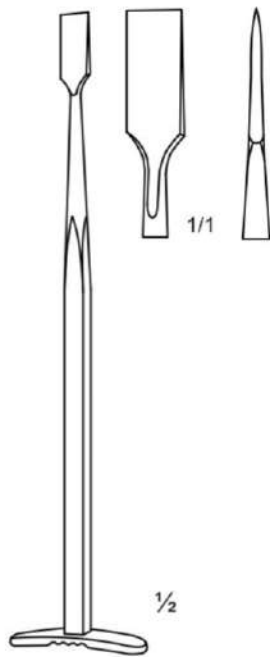

**SMILLIE**

▶ 36-7901 17.0cm

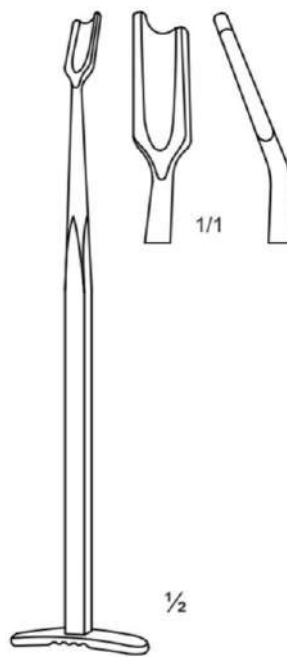

**SMILLIE**

▶ 36-7902 17.0cm

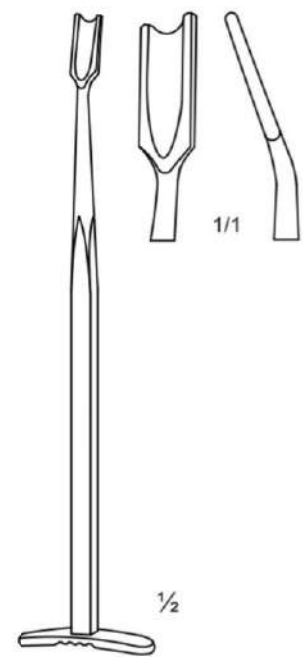

**SMILLIE**

▶ 36-7903 17.0cm



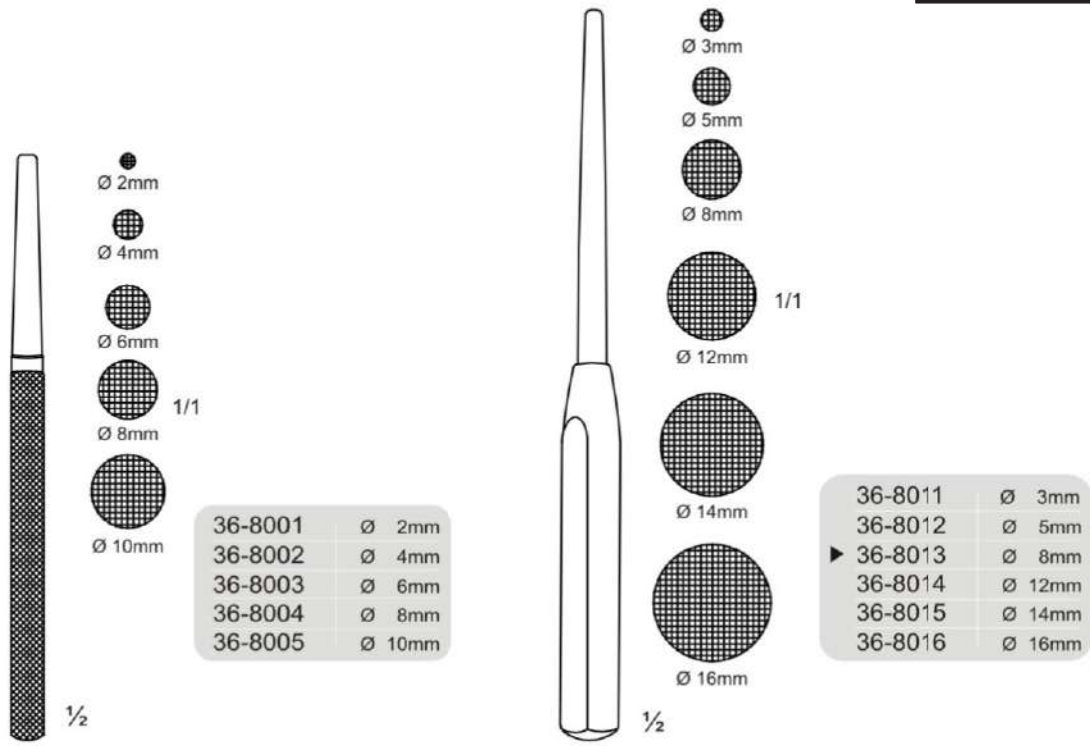

**CASPAR**  
with artificial wood handle

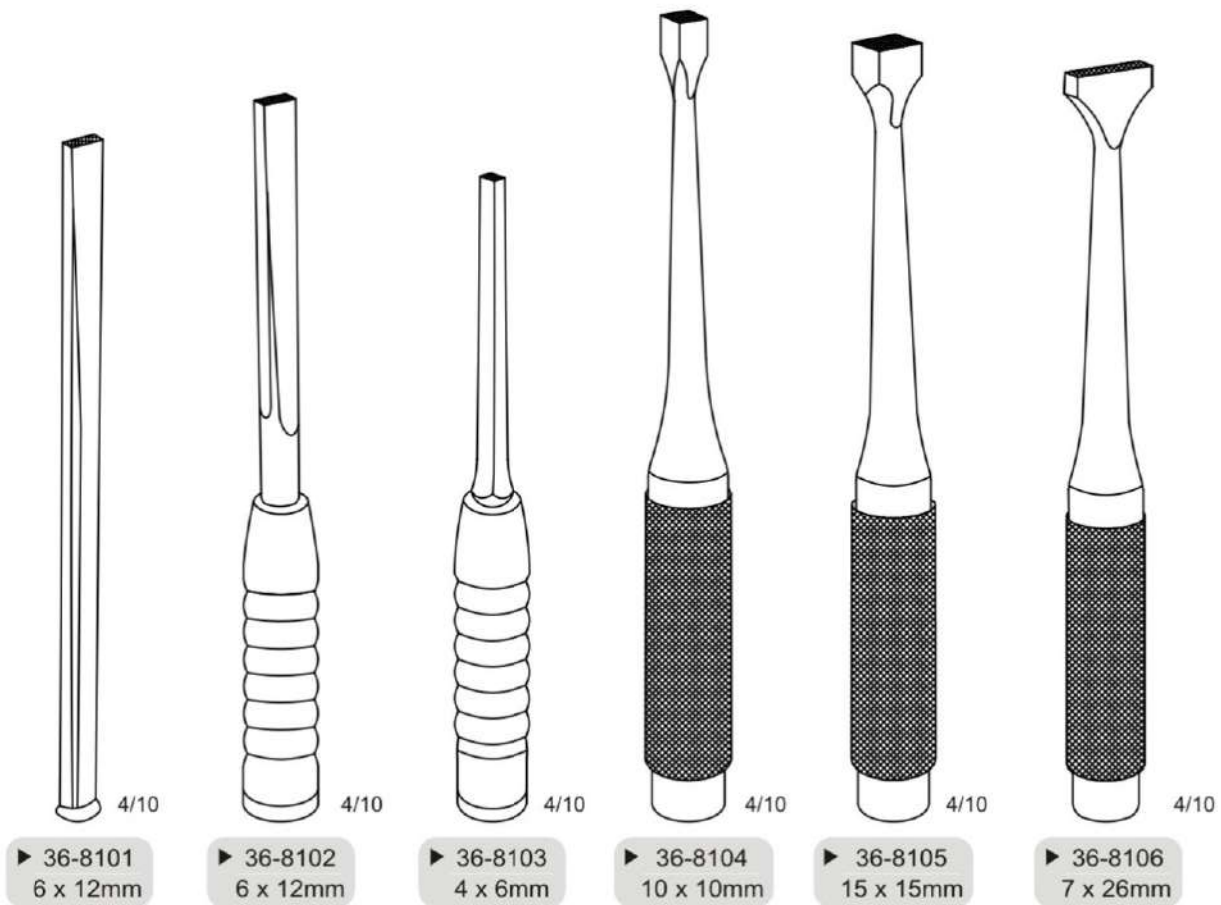



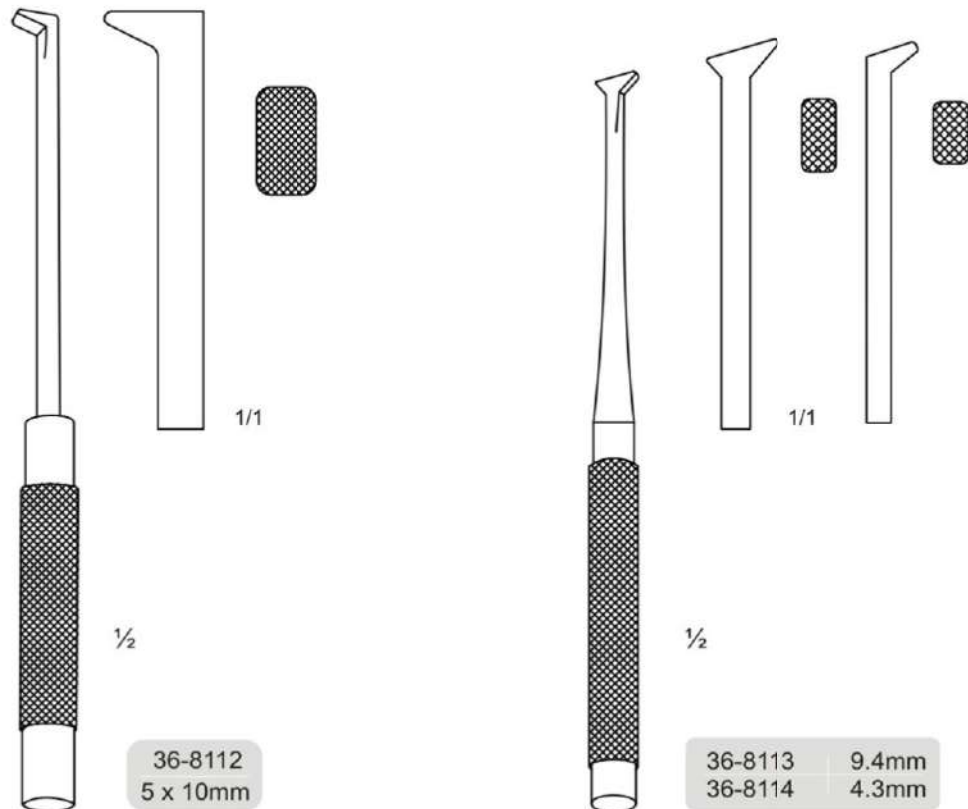
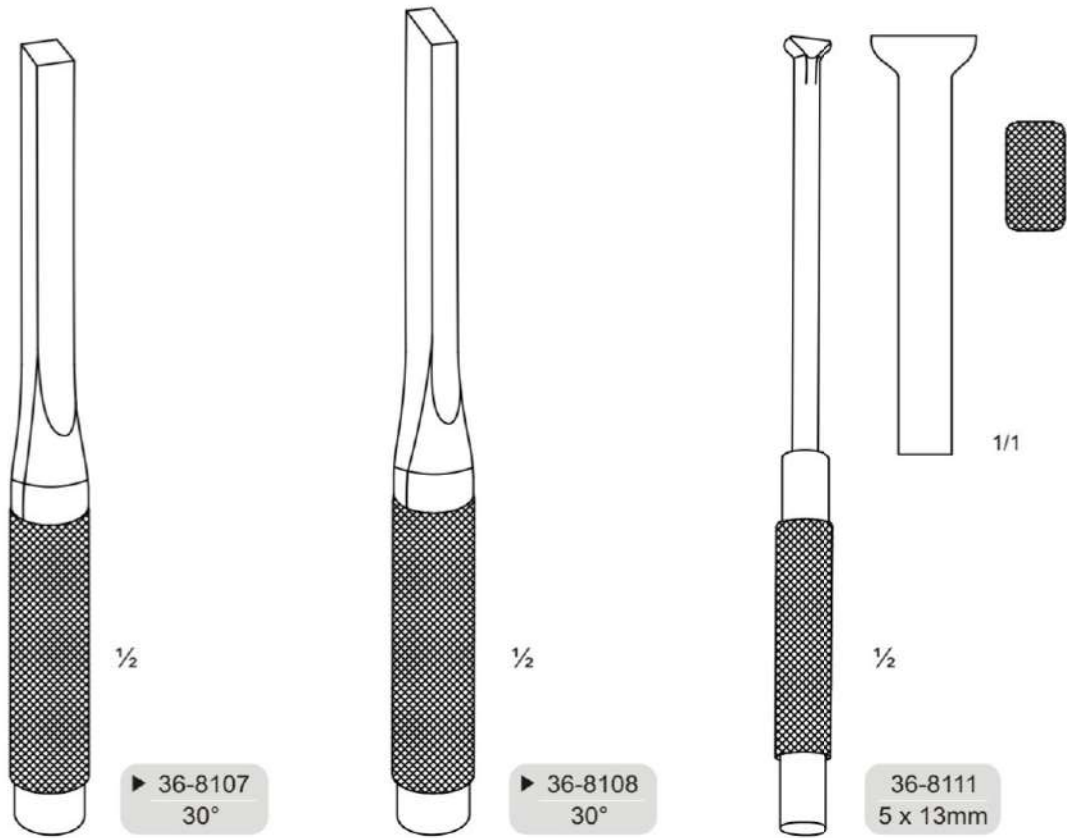

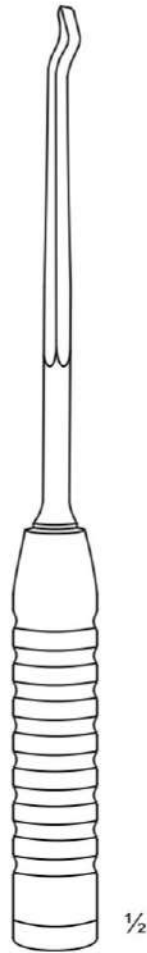

with artificial wood handle

▶ 36-8115  
4.5 x 10.0mm

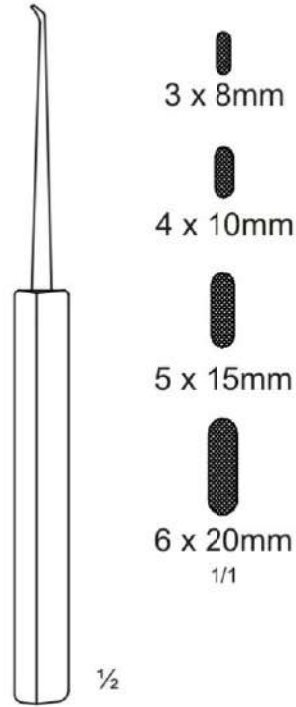

**SYPERT**

with artificial wood handle

36-8116	3 x 8mm
36-8117	4 x 10mm
36-8118	5 x 15mm
36-8119	6 x 20mm



**RUSH PIN**

▶ 36-8121 | 17.0cm | 7 x 10mm



**RUSH PIN**

▶ 36-8122 | 17.0cm | 10 x 19mm



**CIRCLE**

▶ 36-8123 | 13.0cm | ø 5.0mm

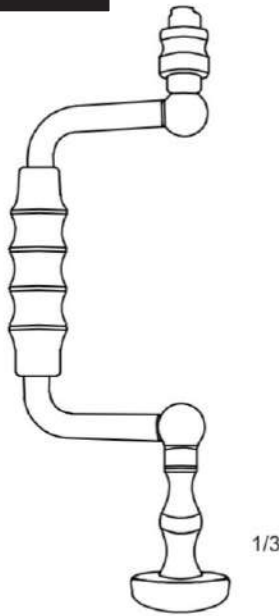

**HUDSON**

Hand bone drill, complete, consist of  
 1 Hand bone drill  
 1 Extension piece  
 1 Burr  $\varnothing$  10mm  
 1 Burr  $\varnothing$  14mm  
 1 Burr  $\varnothing$  16mm  
 1 Burr  $\varnothing$  22mm

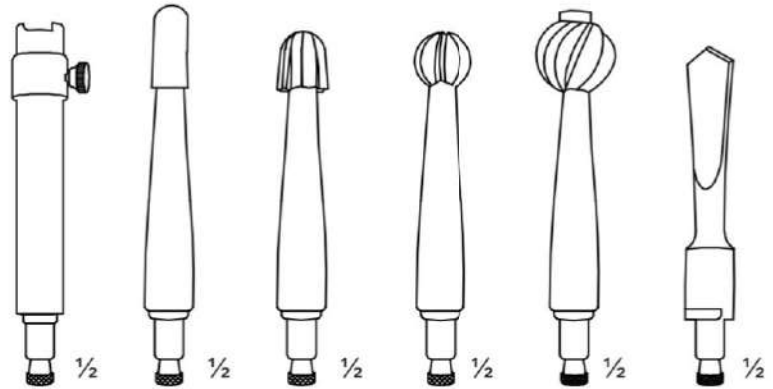
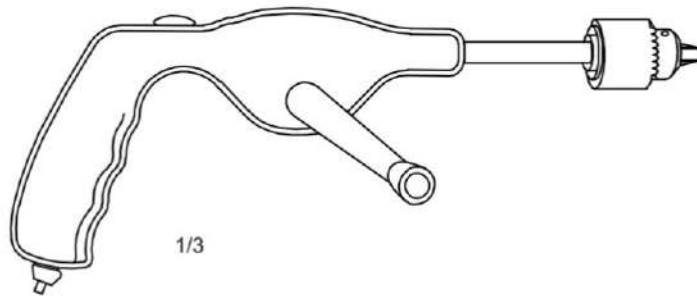
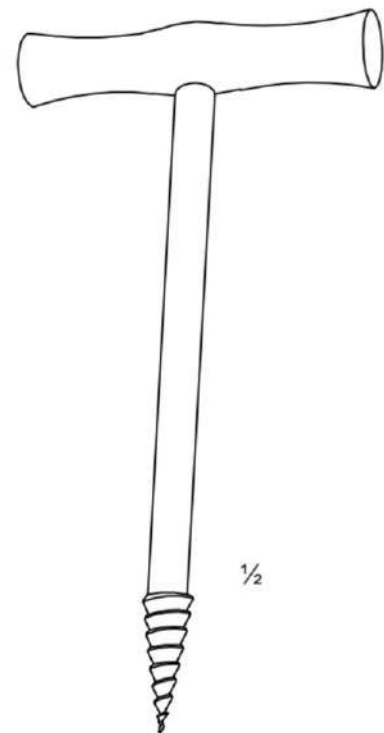

Fig. 1 Fig. 2 Fig. 3 Fig. 4 Fig. 5 Fig. 6

36-8200 SET		
▶ 36-8201	1 Hand bone drill	
36-8211	1 Extension piece	Fig. 1
36-8212	1 Burr $\varnothing$ 10mm	Fig. 2
36-8213	1 Burr $\varnothing$ 14mm	Fig. 3
36-8214	1 Burr $\varnothing$ 16mm	Fig. 4
36-8215	1 Burr $\varnothing$ 22mm	Fig. 5
36-8216	1 Burr $\varnothing$ 13mm	Fig. 6



**UNIVERSAL**



**COCK  
Screw**



2.5mm



3.5mm



Screw Driver  
with artificial wood handle

36-8501 25.0cm

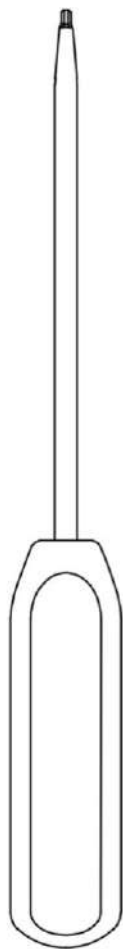

Screw Driver  
with artificial wood handle

▶ 36-8502 25.0cm

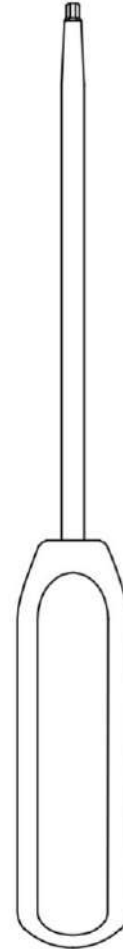

Screw Driver  
with artificial wood handle

▶ 36-8503 25.0cm

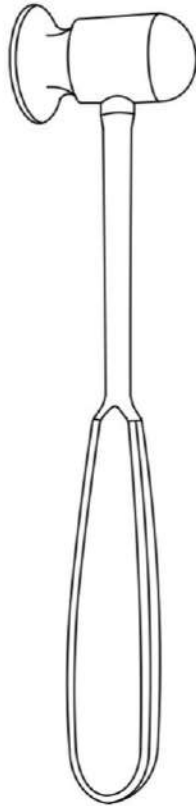

½

**DOYEN**

36-8601	∅ 25mm	120g
36-8602	∅ 30mm	180g
36-8603	∅ 35mm	260g

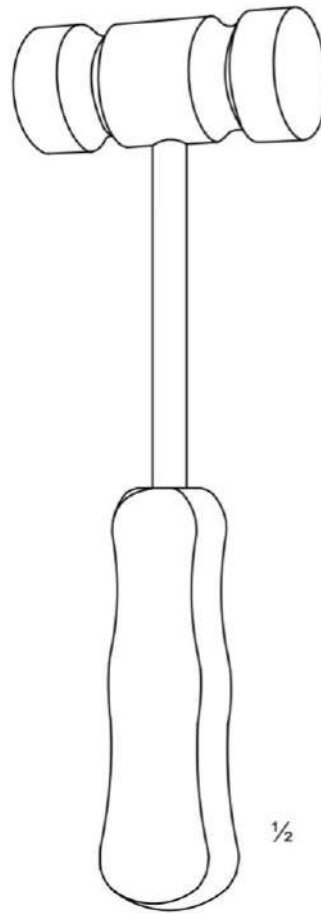

½

with artificial wood handle

▶ 36-8610	∅ 30mm	450g
▶ 36-8620	∅ 50mm	900g

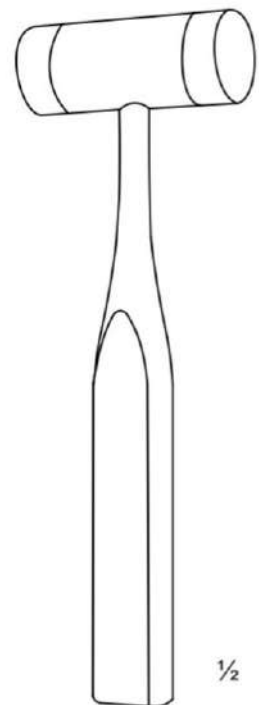

½

with plastic disks

▶ 36-8630	∅ 25mm	140g
-----------	--------	------

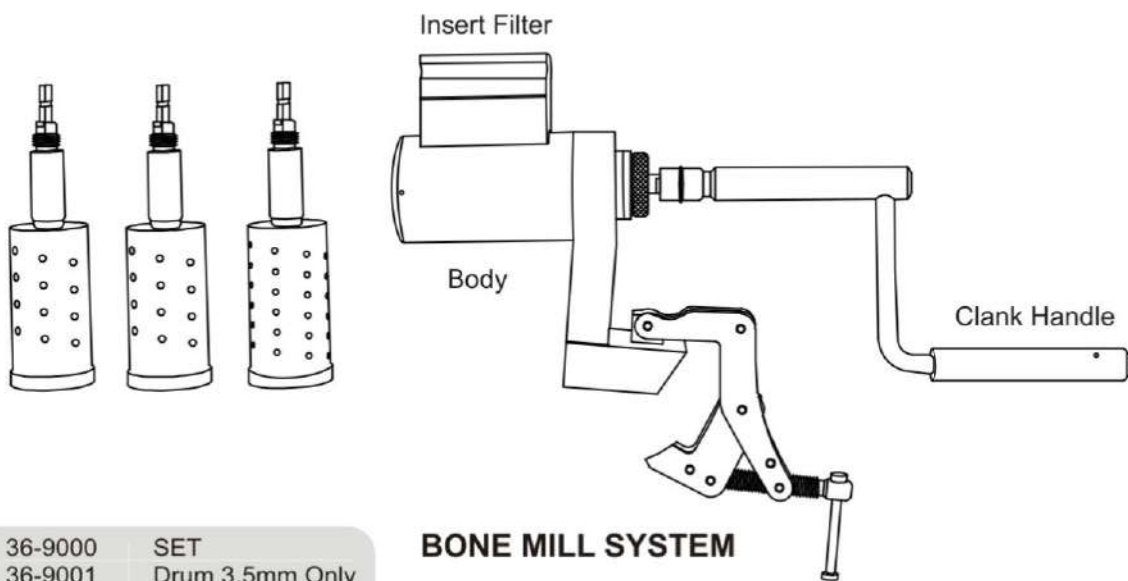

- ▶ 36-9000 SET
- ▶ 36-9001 Drum 3.5mm Only
- ▶ 36-9002 Drum 4.5mm Only
- ▶ 36-9003 Drum 6.0mm Only
- ▶ 36-9010 Insert Filter Only
- ▶ 36-9020 Clank Handle Only
- ▶ 36-9030 Body Only

**BONE MILL SYSTEM**

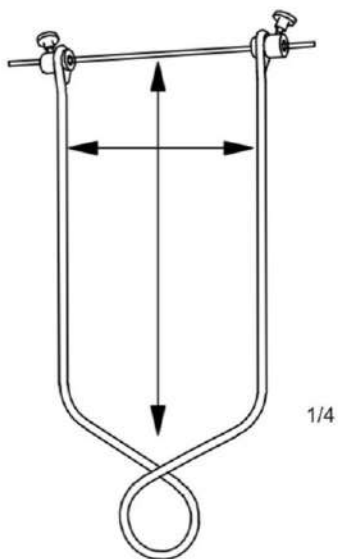

**BOHLER**  
wire extension bow

- ▶ 36-9101 150 x 95mm
- ▶ 36-9102 205 x 110mm
- ▶ 36-9103 260 x 120mm

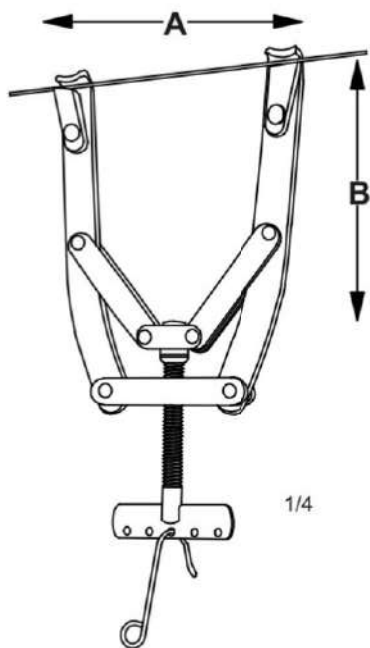

**KIRSCHNER**  
wire traction bow

- |           | A      | B           |
|-----------|--------|-------------|
| ▶ 36-9201 | 10.5cm | 80 - 95mm   |
| ▶ 36-9202 | 16.0cm | 90 - 120mm  |
| ▶ 36-9203 | 20.0cm | 140 - 170mm |

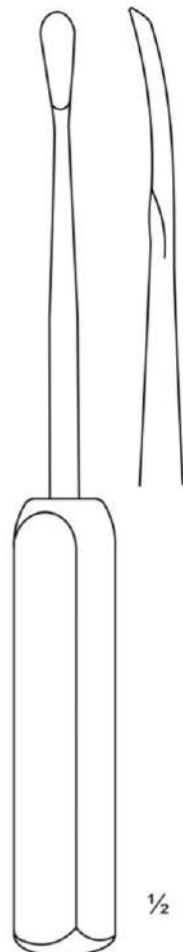
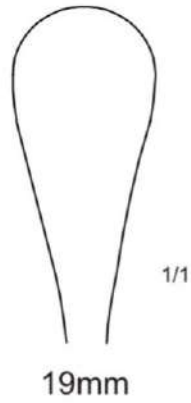
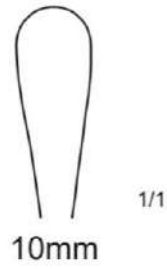

**COBB**

with artificial wood handle

▶ 37-0101	25.0cm	10mm
▶ 37-0102	25.0cm	13mm
▶ 37-0103	25.0cm	19mm
▶ 37-0104	25.0cm	25mm
▶ 37-0110	35.0cm	10mm
▶ 37-0120	35.0cm	13mm
▶ 37-0130	35.0cm	19mm



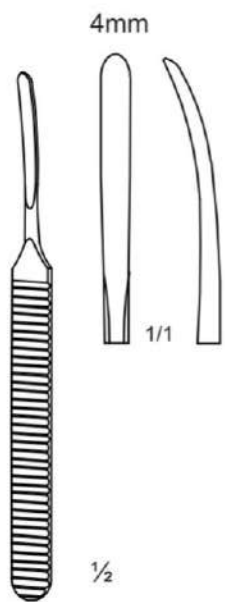

**WILLIGER**

37-0201 14.0cm

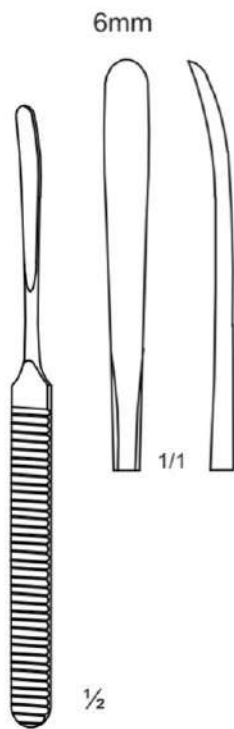

**WILLIGER**

37-0202 16.0cm

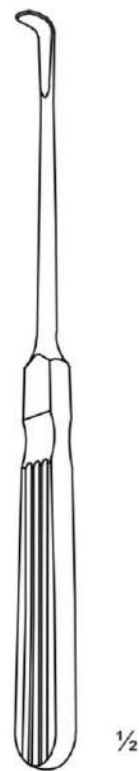

Periosteal Elevator

37-0300 20.0cm

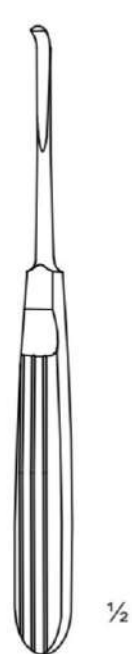

**MUHLING**

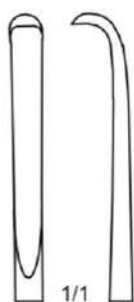

4mm  
Fig. 1

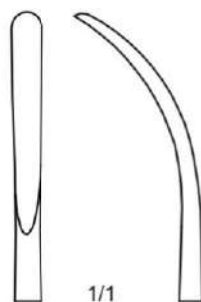

1/1  
4mm  
Fig. 2

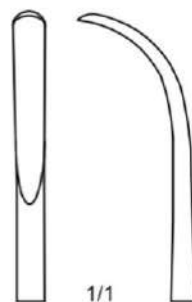

1/1  
4mm  
Fig. 3



1/1  
6mm  
Fig. 4

- 37-0401 Fig. 1
- 37-0402 Fig. 2
- 37-0403 Fig. 3
- 37-0404 Fig. 4

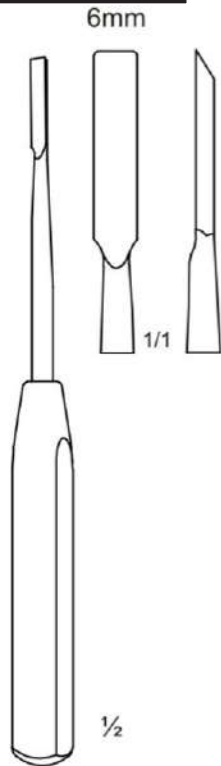

with artificial wood handle

37-0501 18.5cm

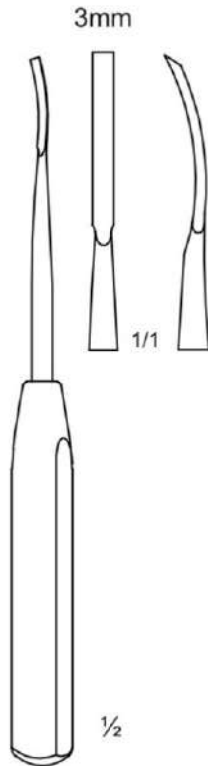

with artificial wood handle

37-0502 19.0cm

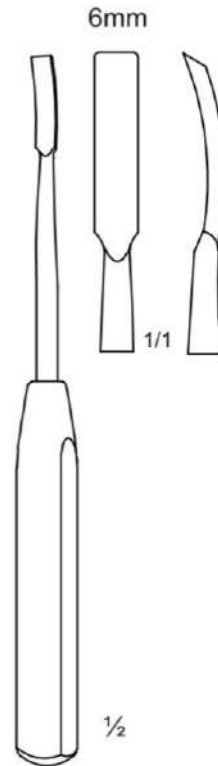

with artificial wood handle

37-0503 19.0cm

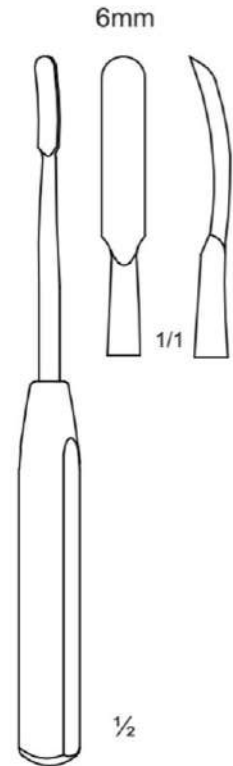

with artificial wood handle

37-0504 19.0cm



**IOWA-UNIVERSITY**

37-0600 18.4cm

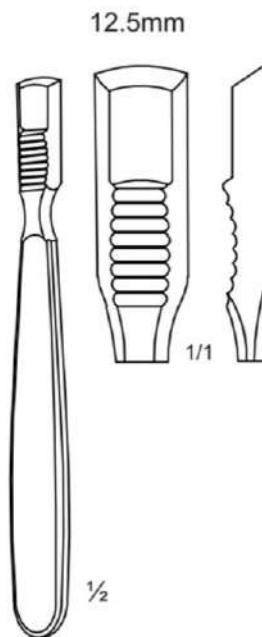

**FARABEUF**

37-0701 15.0cm

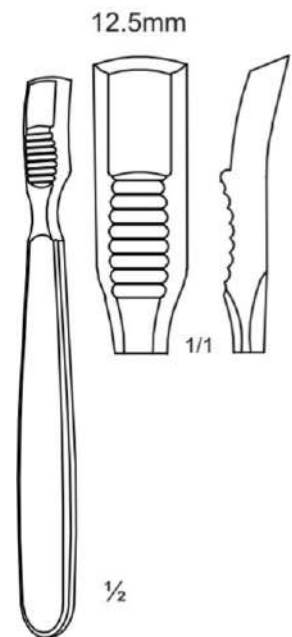

**FARABEUF**

37-0711 15.0cm

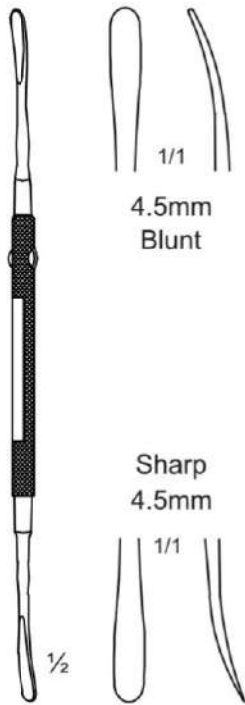

**FREER**

▶ 37-0801 | 19.0cm

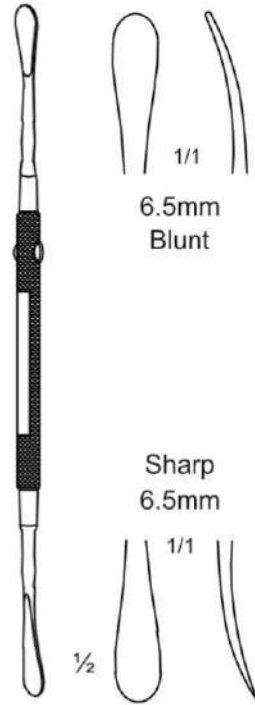

**FREER**

▶ 37-0802 | 19.0cm

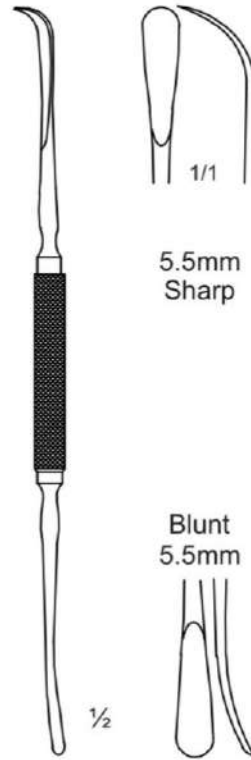

**FREER**

▶ 37-0803 | 21.0cm



**FREER**

▶ 37-0804 | 19.0cm



**FREER**

▶ 37-0805 | 19.0cm

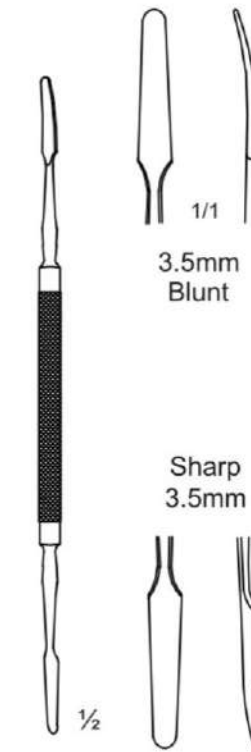

**KILLIAN**

▶ 37-0806 | 18.0cm



**LONG FREER**

▶ 37-0807 | 33.0cm



1/2

### CUSHING

- ▶ 37-0901 20.3cm
- ▶ 37-0902 18.0cm
- ▶ 37-0903 20.0cm



1/2

### CUSHING

- ▶ 37-0904 19.0cm



1/2

### CUSHING

- ▶ 37-0905 19.0cm  
15mm Wide

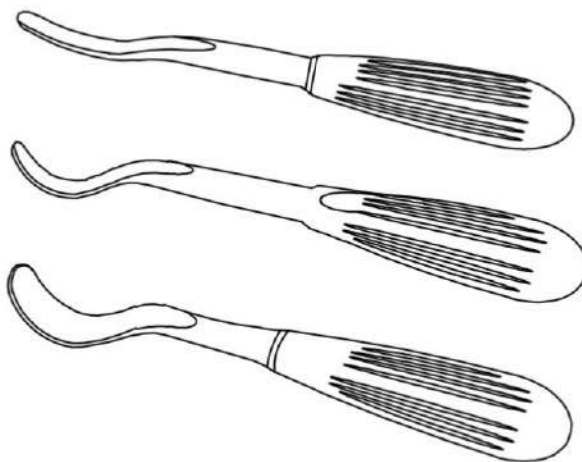

1/2

### CREGO

- ▶ 37-1001 Fig. 1
- ▶ 37-1002 Fig. 2
- ▶ 37-1003 Fig. 3

8mm



1/1

Fig. 1

8mm

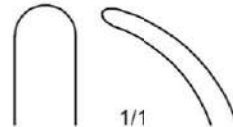

1/1

Fig. 2

14mm

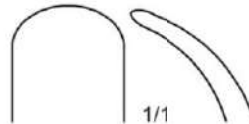

1/1

Fig. 3



**MINI-HOHMANN**

▶ 37-1101 12.5cm

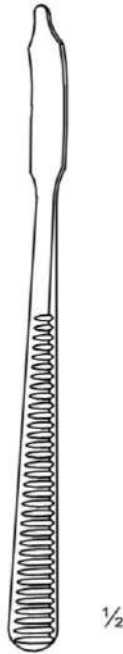

**MINI-HOHMANN**

▶ 37-1102 17.0cm



**MINI-HOHMANN**

▶ 37-1103 16.5cm

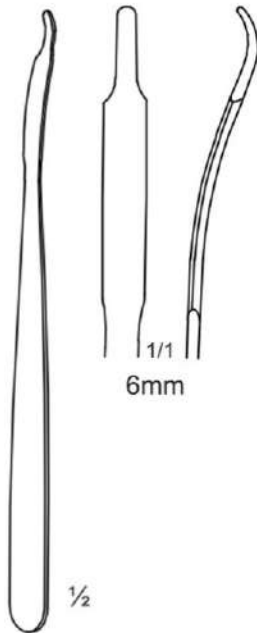

**MINI-HOHMANN**

▶ 37-1104 16.0cm

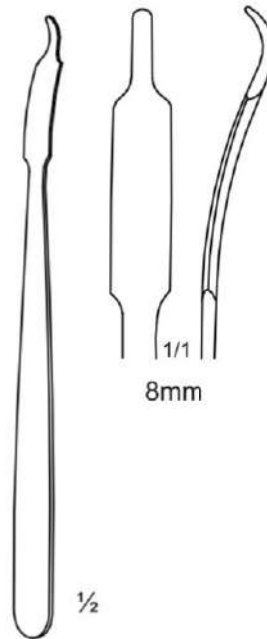

**MINI-HOHMANN**

▶ 37-1105 16.0cm

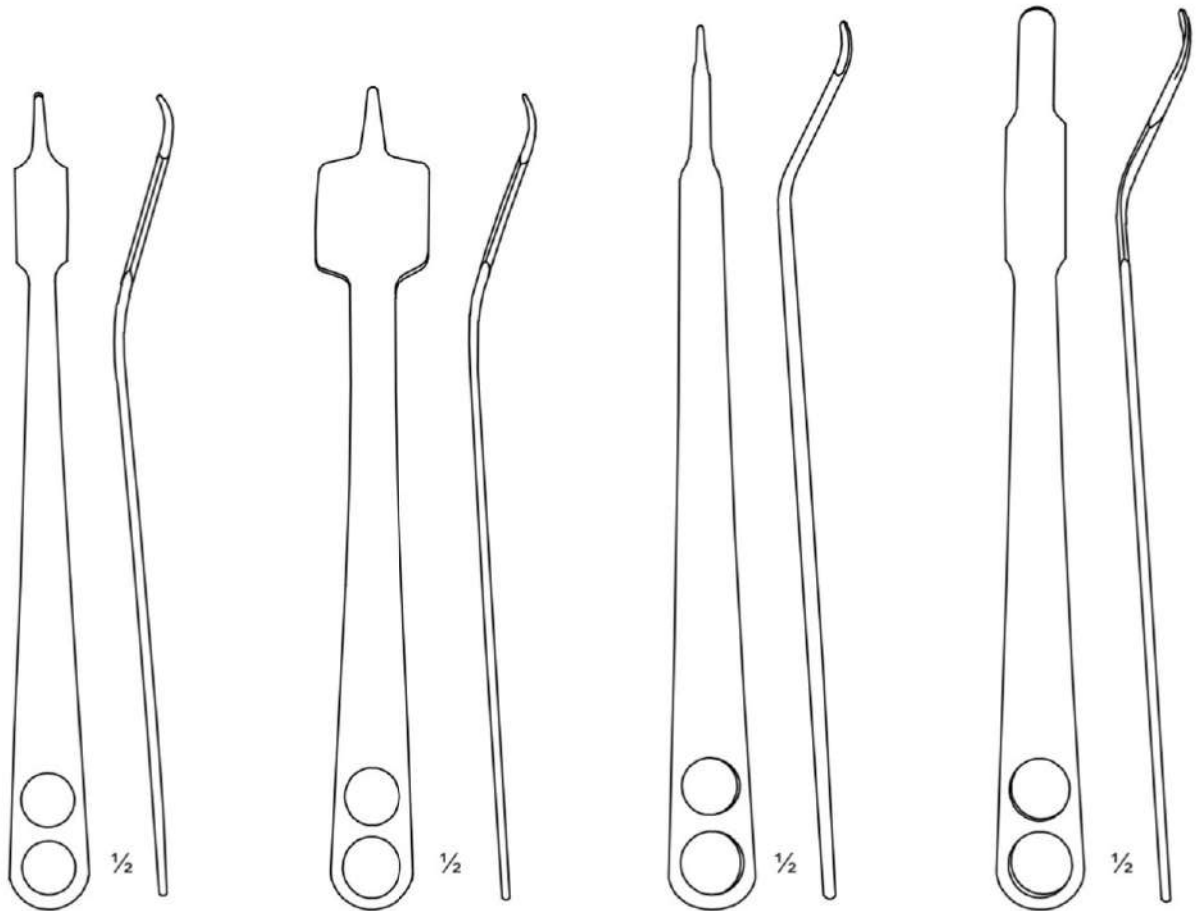
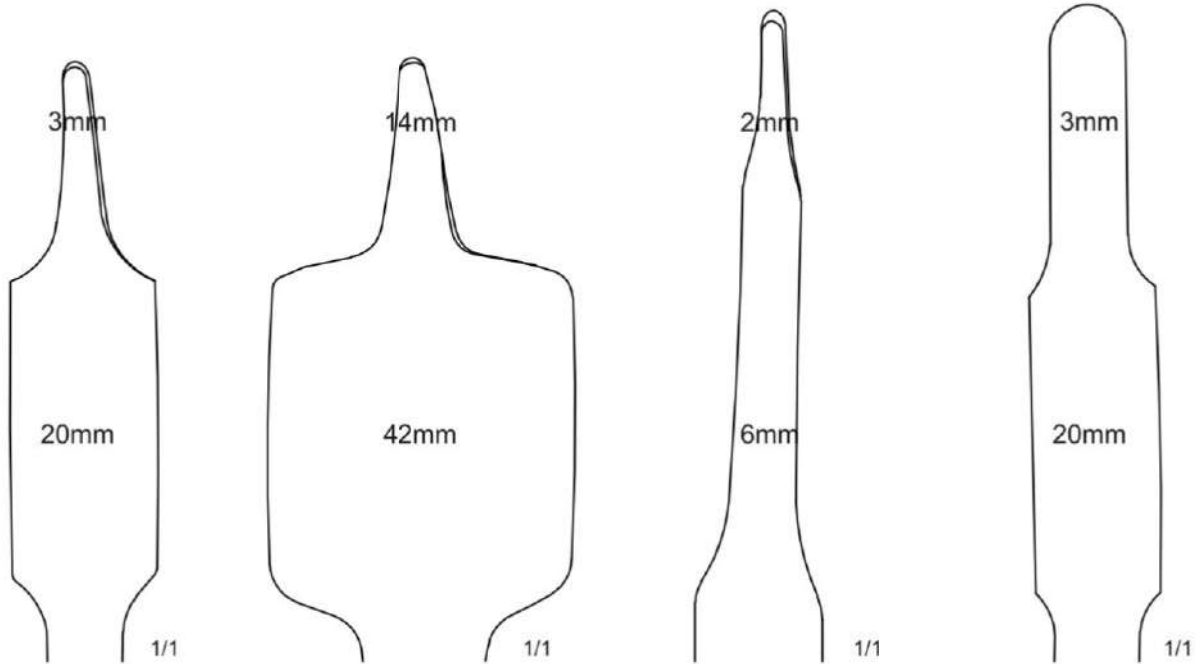

**HOHMANN**

▶ 37-1201 22.0cm

**HOHMANN**

▶ 37-1202 22.0cm

**HOHMANN**

▶ 37-1203 24.0cm

**HOHMANN**

▶ 37-1204 24.0cm

# Bone Levers

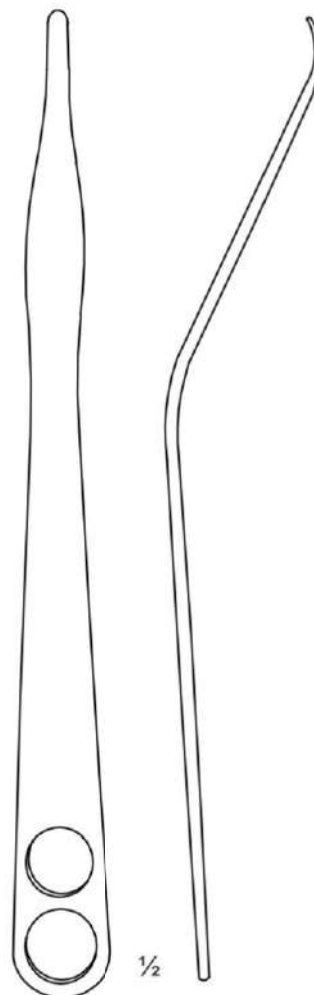
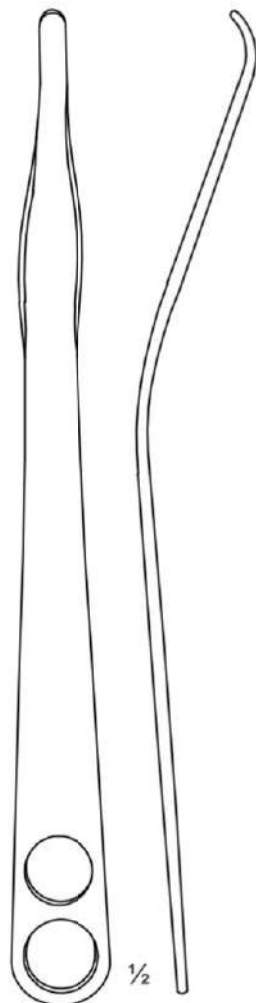
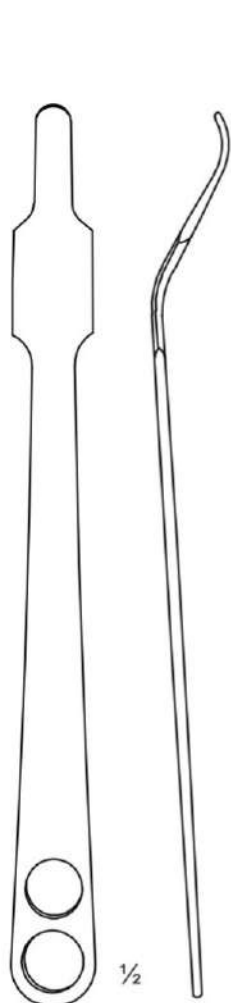
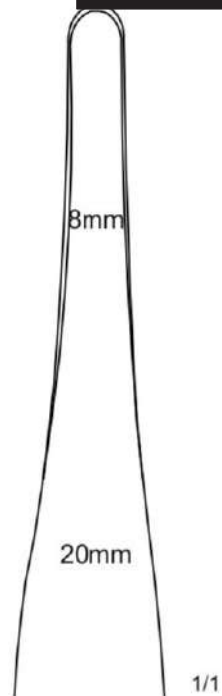
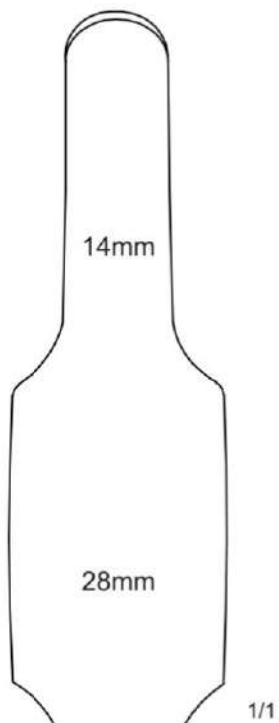

**MINI-HOHMANN**

▶ 37-1205 | 25.0cm

**MINI-HOHMANN**

▶ 37-1206 | 27.0cm

**MINI-HOHMANN**

▶ 37-1207 | 29.0cm



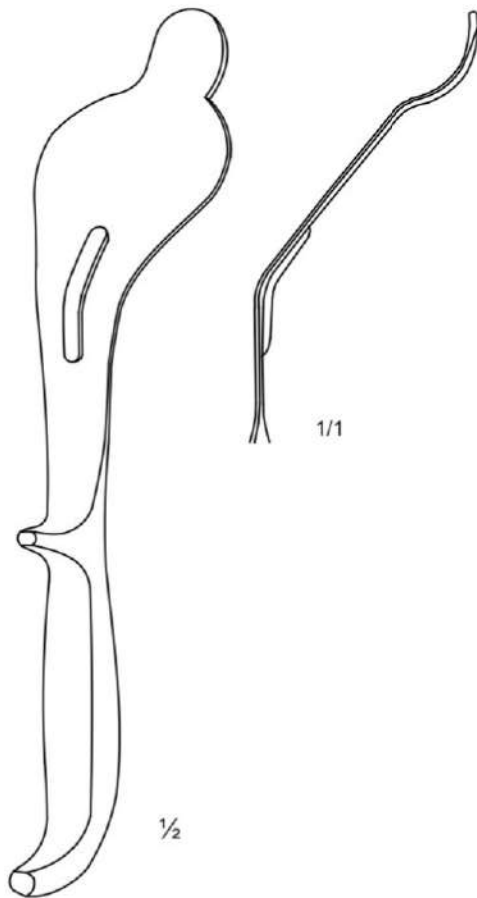
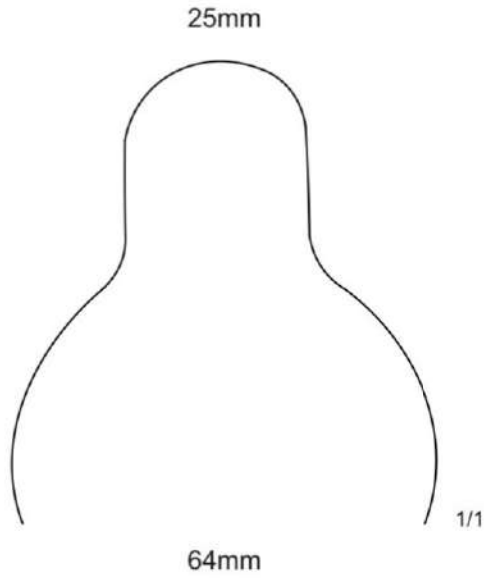

**BENNETT**

▶ 37-1300 23.5cm

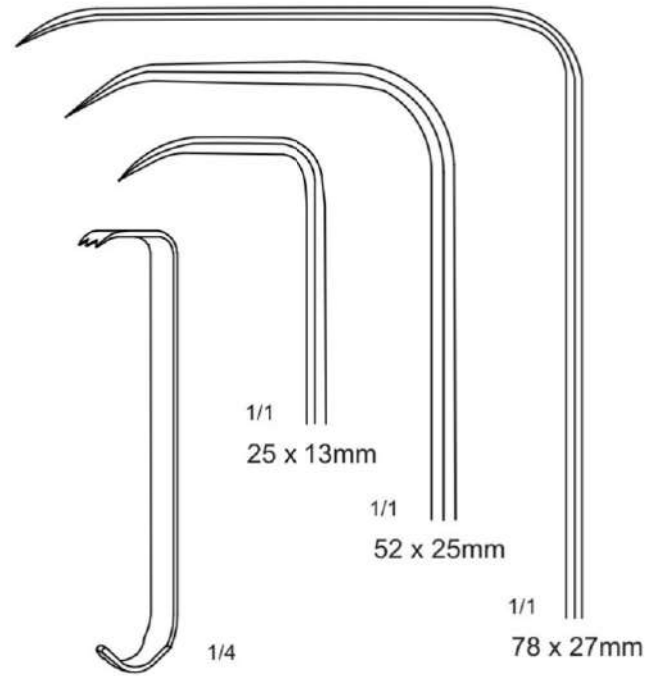

**HIBBS**

▶ 15-2501	23.5cm	25 x 13mm
▶ 15-2502	24.0cm	52 x 25mm
▶ 15-2503	24.5cm	78 x 27mm

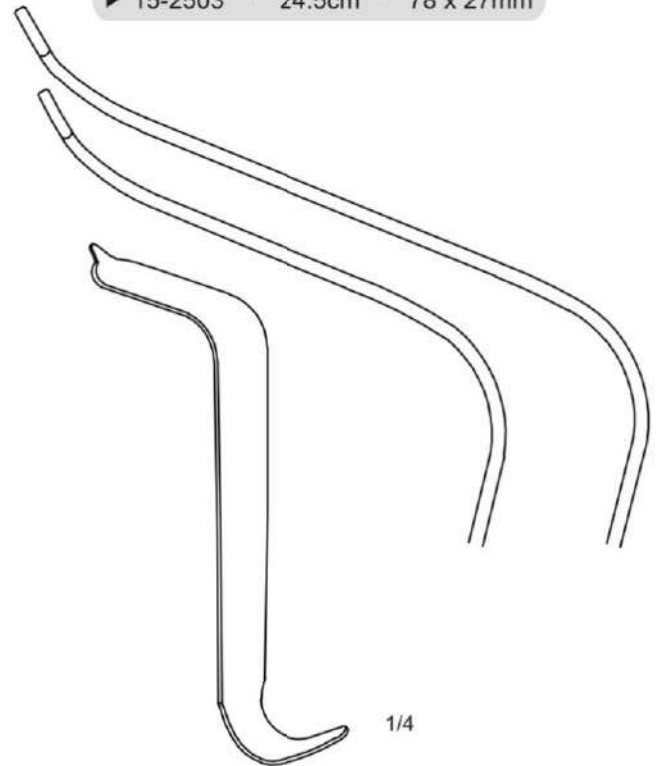

**TAYLOR**

▶ 15-2701	16.5cm	75 x 30mm
▶ 15-2702	16.5cm	100 x 30mm

**Bone Hooks**

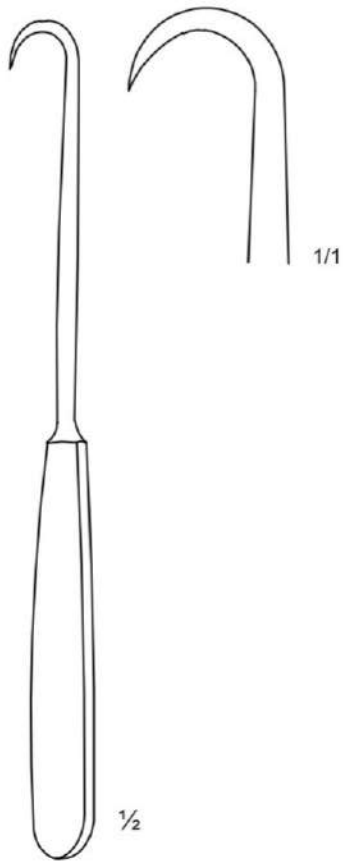

▶ 37-1401 20.3cm

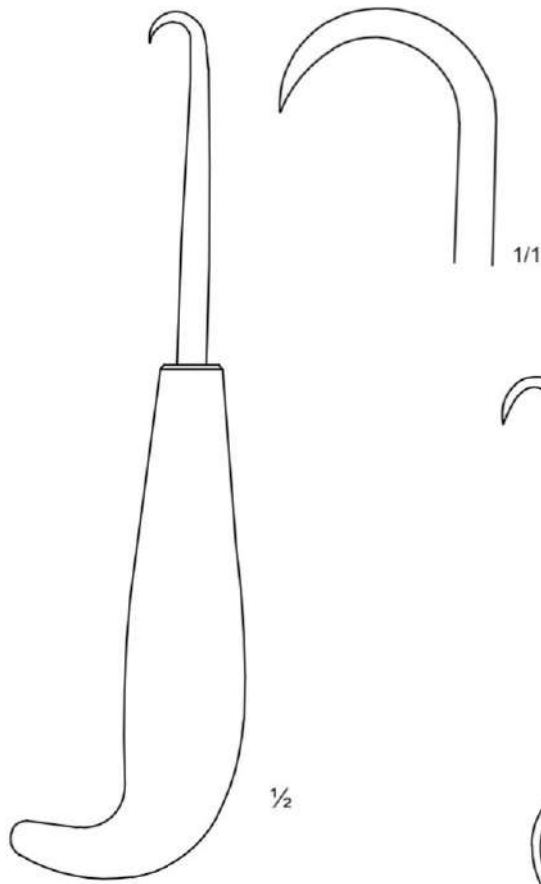

▶ 37-1402 23.0cm

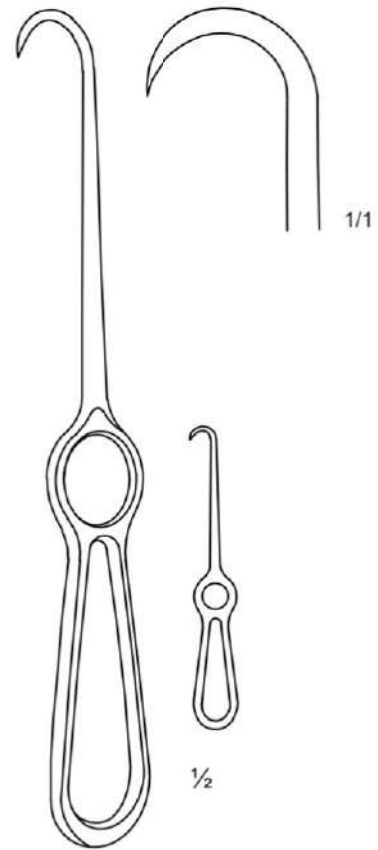

37-1403 22.0cm

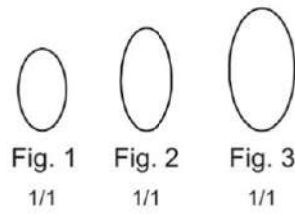
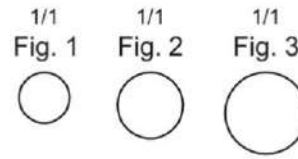

Fig. 1 1/1    Fig. 2 1/1    Fig. 3 1/1



1/1 Fig. 1    1/1 Fig. 2    1/1 Fig. 3

1/2

**VOLKMANN**

37-1501	13.0cm	Fig. 1
37-1502	16.0cm	Fig. 2
37-1503	20.0cm	Fig. 3

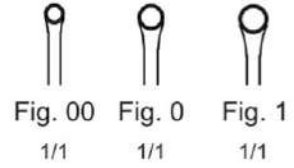
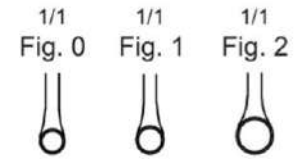

Fig. 00 1/1    Fig. 0 1/1    Fig. 1 1/1



1/1 Fig. 0    1/1 Fig. 1    1/1 Fig. 2

1/2

**MARTINI**

37-1601	Fig. 00/0
37-1602	Fig. 0/1
37-1603	Fig. 1/2

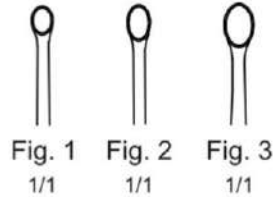
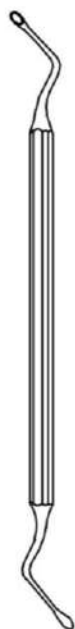
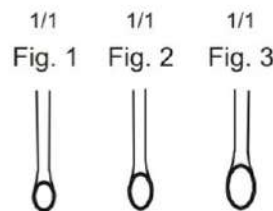

Fig. 1 1/1    Fig. 2 1/1    Fig. 3 1/1



1/1 Fig. 1    1/1 Fig. 2    1/1 Fig. 3

1/2

**HEMINGWAY**

37-1701	Fig. 1
37-1702	Fig. 2
37-1703	Fig. 3

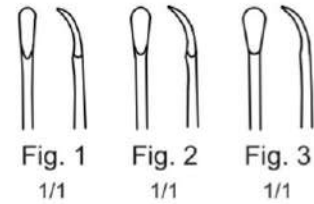
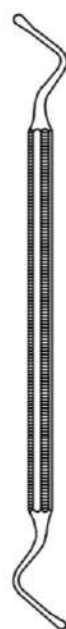
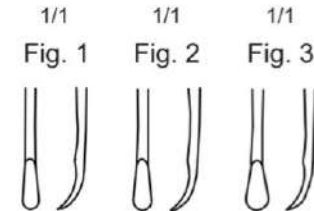

Fig. 1 1/1    Fig. 2 1/1    Fig. 3 1/1



1/1 Fig. 1    1/1 Fig. 2    1/1 Fig. 3

1/2

**LUCAS**

37-1801	Fig. 1
37-1802	Fig. 2
37-1803	Fig. 3

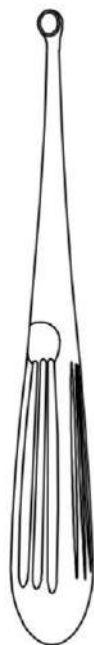

1/2

**BRUNS**

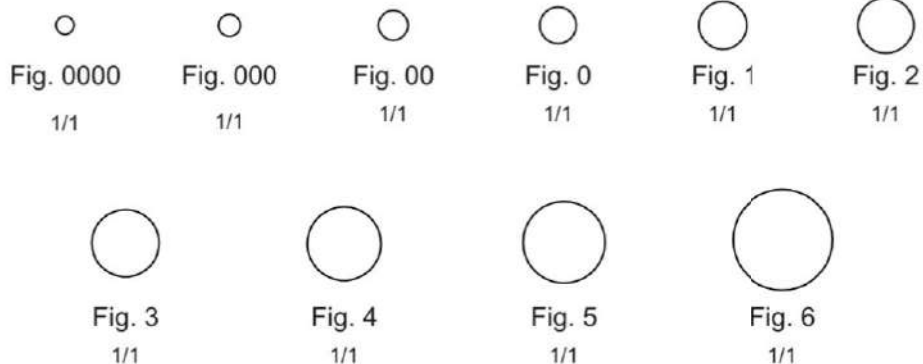

37-1901	2mm	Fig. 0000
37-1902	3mm	Fig. 000
37-1903	4mm	Fig. 00
37-1904	5mm	Fig. 0
37-1905	6mm	Fig. 1

37-1906	8mm	Fig. 2
37-1907	10mm	Fig. 3
37-1908	12mm	Fig. 4
37-1909	16mm	Fig. 5
37-1910	18mm	Fig. 6

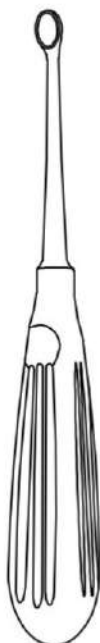

1/2

**VOLKMANN**

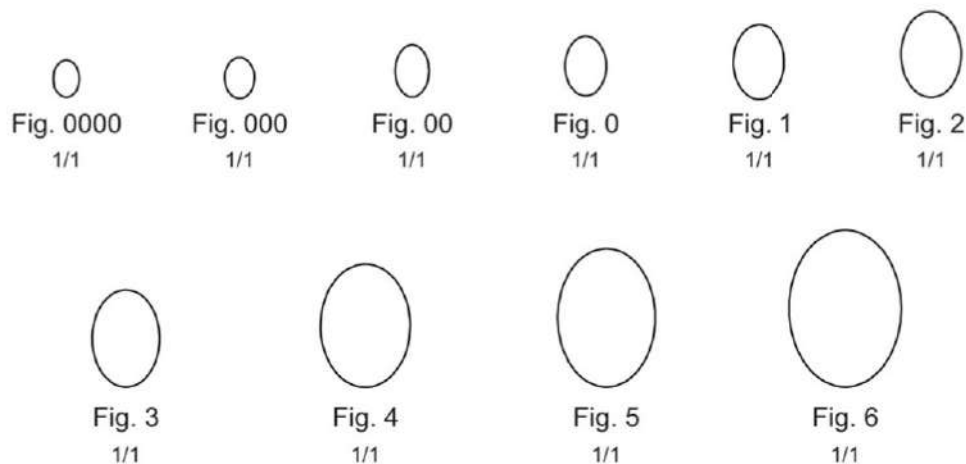

37-1901	2mm	Fig. 0000
37-1902	3mm	Fig. 000
▶ 37-1903	4mm	Fig. 00
▶ 37-1904	5mm	Fig. 0
▶ 37-1905	6mm	Fig. 1

▶ 37-1906	8mm	Fig. 2
▶ 37-1907	10mm	Fig. 3
▶ 37-1908	12mm	Fig. 4
▶ 37-1909	16mm	Fig. 5
▶ 37-1910	18mm	Fig. 6



1/2

**VOLKMANN**

with artificial wood handle

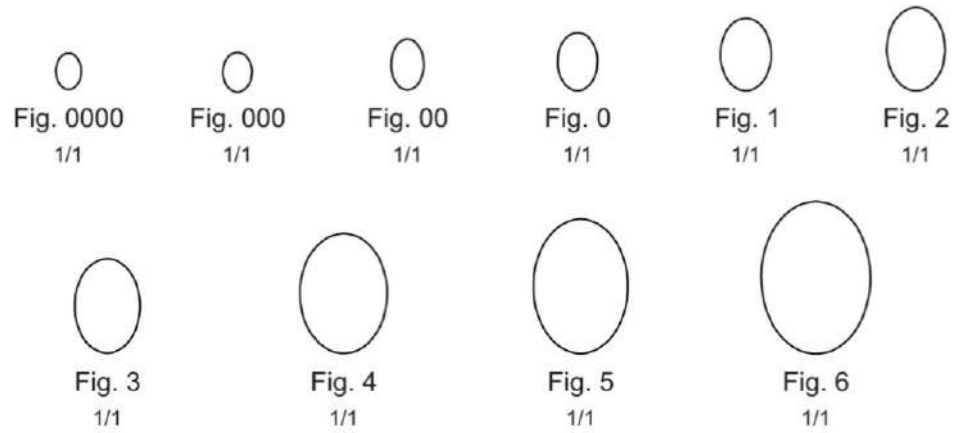

37-2021	2.8mm	Fig. 0000
37-2022	3.6mm	Fig. 000
37-2023	4.4mm	Fig. 00
37-2024	5.2mm	Fig. 0
37-2025	6.8mm	Fig. 1

37-2026	8.5mm	Fig. 2
37-2027	10.0mm	Fig. 3
37-2028	11.5mm	Fig. 4
37-2029	13.0mm	Fig. 5
37-2030	14.5mm	Fig. 6



1/2

**VOLKMANN**

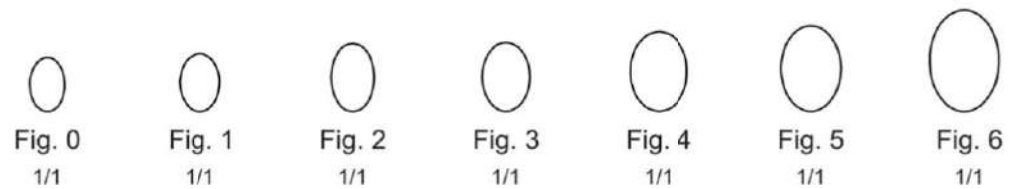

37-2044	5.2mm	Fig. 0
37-2045	6.8mm	Fig. 1
37-2046	8.5mm	Fig. 2
37-2047	10.0mm	Fig. 3
37-2048	11.5mm	Fig. 4
37-2049	13.0mm	Fig. 5
37-2050	14.5mm	Fig. 6

# Curettes



**LEMPERT**

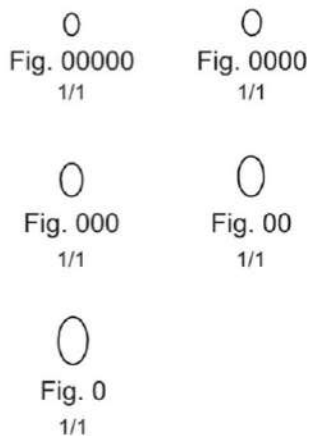

37-2201	1.7mm	Fig. 00000
▶ 37-2202	2.0mm	Fig. 0000
▶ 37-2203	2.4mm	Fig. 000
▶ 37-2204	2.7mm	Fig. 00
▶ 37-2205	3.0mm	Fig. 0

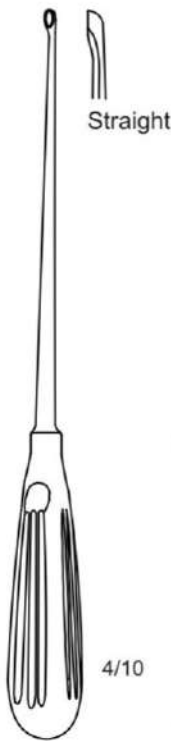

**CASPAR**

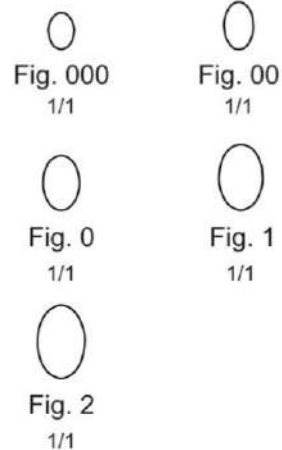

▶ 37-2301	25.0cm	3.6mm	Fig. 000
▶ 37-2302	25.0cm	4.4mm	Fig. 00
▶ 37-2303	25.0cm	5.2mm	Fig. 0
▶ 37-2304	25.0cm	6.8mm	Fig. 1
▶ 37-2305	25.0cm	8.5mm	Fig. 2
▶ 37-2401	35.0cm	3.6mm	Fig. 000
▶ 37-2402	35.0cm	4.4mm	Fig. 00
▶ 37-2403	35.0cm	5.2mm	Fig. 0
▶ 37-2404	35.0cm	6.8mm	Fig. 1
▶ 37-2405	35.0cm	8.5mm	Fig. 2



**CASPAR**

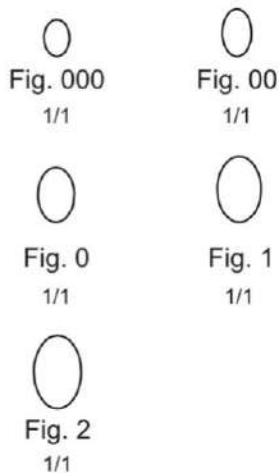

▶ 37-2311	25.0cm	3.6mm	Fig. 000
▶ 37-2312	25.0cm	4.4mm	Fig. 00
▶ 37-2313	25.0cm	5.2mm	Fig. 0
▶ 37-2314	25.0cm	6.8mm	Fig. 1
▶ 37-2315	25.0cm	8.5mm	Fig. 2
▶ 37-2411	35.0cm	3.6mm	Fig. 000
▶ 37-2412	35.0cm	4.4mm	Fig. 00
▶ 37-2413	35.0cm	5.2mm	Fig. 0
▶ 37-2414	35.0cm	6.8mm	Fig. 1
▶ 37-2415	35.0cm	8.5mm	Fig. 2



**CASPAR**

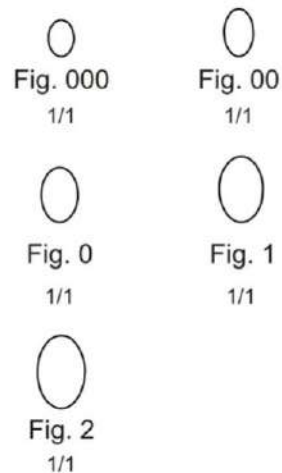

▶ 37-2321	25.0cm	3.6mm	Fig. 000
▶ 37-2322	25.0cm	4.4mm	Fig. 00
▶ 37-2323	25.0cm	5.2mm	Fig. 0
▶ 37-2324	25.0cm	6.8mm	Fig. 1
▶ 37-2325	25.0cm	8.5mm	Fig. 2
▶ 37-2421	35.0cm	3.6mm	Fig. 000
▶ 37-2422	35.0cm	4.4mm	Fig. 00
▶ 37-2423	35.0cm	5.2mm	Fig. 0
▶ 37-2424	35.0cm	6.8mm	Fig. 1
▶ 37-2425	35.0cm	8.5mm	Fig. 2



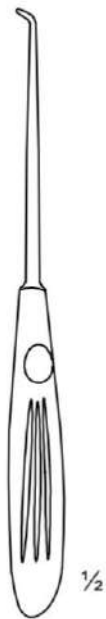

**SPINAL**

▶ 37-2501  
3 x 5mm 130°

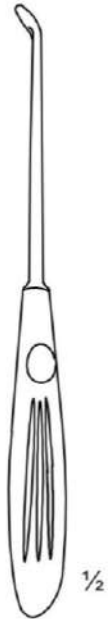

**SPINAL**

▶ 37-2502  
7 x 10mm 130°

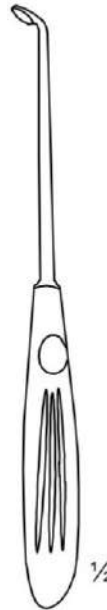

**SPINAL**

▶ 37-2503  
7 x 10mm 150°

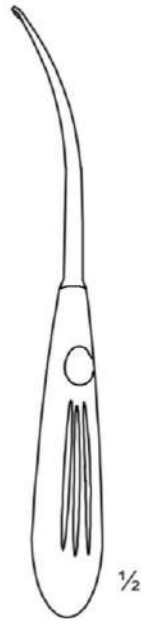

**SPINAL**

▶ 37-2511  
3 x 5mm Curved

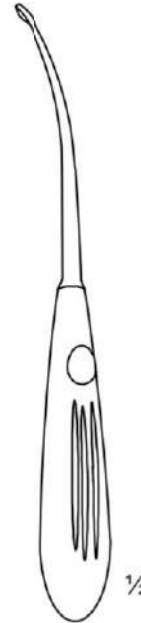

**SPINAL**

▶ 37-2512  
5 x 7mm Curved



**SPINAL**

▶ 37-2513  
7 x 9mm Curved



**BONE**

with artificial wood handle

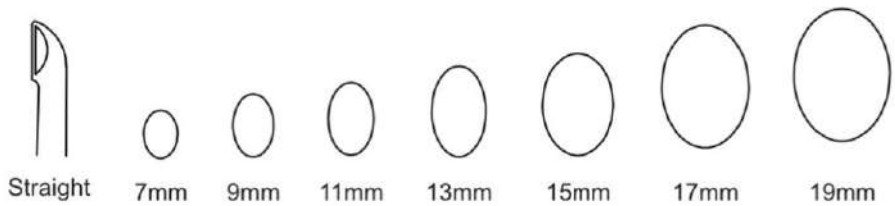

37-2601	7mm	Straight
37-2602	9mm	Straight
37-2603	11mm	Straight
37-2604	13mm	Straight
37-2605	15mm	Straight
37-2606	17mm	Straight
37-2607	19mm	Straight
37-2611	7mm	Forward
37-2612	9mm	Forward
37-2613	11mm	Forward
37-2621	7mm	Reverse
37-2622	9mm	Reverse

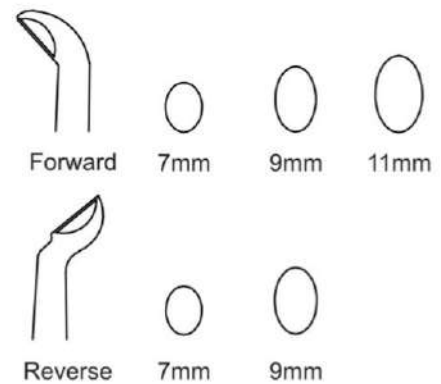



# Curettes



## KARIN

	0	0	0	0	0	0	0	0
Forward Straight	Fig. 0000 1/1	Fig. 000 1/1	Fig. 00 1/1	Fig. 0 1/1	Fig. 1 1/1	Fig. 2 1/1	Fig. 3 1/1	Fig. 4 1/1
	0	0	0	0	0	0	0	0
Forward Angled	Fig. 0000 1/1	Fig. 000 1/1	Fig. 00 1/1	Fig. 0 1/1	Fig. 1 1/1	Fig. 2 1/1	Fig. 3 1/1	Fig. 4 1/1
						0	0	0
Forward Down						Fig. 2 1/1	Fig. 3 1/1	Fig. 4 1/1
	0	0	0	0	0	0	0	0
Reverse Straight	Fig. 0000 1/1	Fig. 000 1/1	Fig. 00 1/1	Fig. 0 1/1	Fig. 1 1/1	Fig. 2 1/1	Fig. 3 1/1	Fig. 4 1/1
	0	0	0	0	0	0	0	0
Reverse Angled	Fig. 0000 1/1	Fig. 000 1/1	Fig. 00 1/1	Fig. 0 1/1	Fig. 1 1/1	Fig. 2 1/1	Fig. 3 1/1	Fig. 4 1/1
						0	0	0
Reverse Down						Fig. 2 1/1	Fig. 3 1/1	Fig. 4 1/1

▶ 37-2701	21.0cm	FS	Fig. 0000
▶ 37-2702	21.0cm	FS	Fig. 000
▶ 37-2703	21.0cm	FS	Fig. 00
▶ 37-2704	21.0cm	FS	Fig. 0
▶ 37-2705	21.0cm	FS	Fig. 1
▶ 37-2706	24.0cm	FS	Fig. 2
▶ 37-2707	24.0cm	FS	Fig. 3
▶ 37-2708	24.0cm	FS	Fig. 4
▶ 37-2711	21.0cm	FA	Fig. 0000
▶ 37-2712	21.0cm	FA	Fig. 000
▶ 37-2713	21.0cm	FA	Fig. 00
▶ 37-2714	21.0cm	FA	Fig. 0
▶ 37-2715	21.0cm	FA	Fig. 1
▶ 37-2716	24.0cm	FA	Fig. 2
▶ 37-2717	24.0cm	FA	Fig. 3
▶ 37-2718	24.0cm	FA	Fig. 4
▶ 37-2726	24.0cm	FD	Fig. 2
▶ 37-2727	24.0cm	FD	Fig. 3
▶ 37-2728	24.0cm	FD	Fig. 4

▶ 37-2801	21.0cm	RS	Fig. 0000
▶ 37-2802	21.0cm	RS	Fig. 000
▶ 37-2803	21.0cm	RS	Fig. 00
▶ 37-2804	21.0cm	RS	Fig. 0
▶ 37-2805	21.0cm	RS	Fig. 1
▶ 37-2806	24.0cm	RS	Fig. 2
▶ 37-2807	24.0cm	RS	Fig. 3
▶ 37-2808	24.0cm	RS	Fig. 4
▶ 37-2811	21.0cm	RA	Fig. 0000
▶ 37-2812	21.0cm	RA	Fig. 000
▶ 37-2813	21.0cm	RA	Fig. 00
▶ 37-2814	21.0cm	RA	Fig. 0
▶ 37-2815	21.0cm	RA	Fig. 1
▶ 37-2816	24.0cm	RA	Fig. 2
▶ 37-2817	24.0cm	RA	Fig. 3
▶ 37-2818	24.0cm	RA	Fig. 4
▶ 37-2826	24.0cm	RD	Fig. 2
▶ 37-2827	24.0cm	RD	Fig. 3
▶ 37-2828	24.0cm	RD	Fig. 4

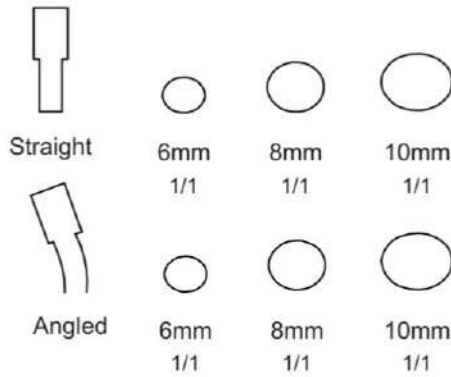

37-2901	6mm	Straight
▶ 37-2902	8mm	Straight
37-2903	10mm	Straight
37-2911	6mm	Curved
37-2912	8mm	Curved
37-2913	10mm	Curved

1/3

**MAGNUM**

with artificial wood handle



37-2914	4mm	Fig. 000
37-2915	5mm	Fig. 00
▶ 37-2916	6mm	Fig. 0

1/3

**CASPAR**

with artificial wood handle



1/3

**BRUNS**

with artificial wood handle

▶ 37-3000 24.0cm 32 x 37mm



1/3

**LONG**

with artificial wood handle

▶ 37-3100 32.5cm 10 x 13mm



1/4

**SPINE**

▶ 37-3200 38.0cm 6 x 8mm



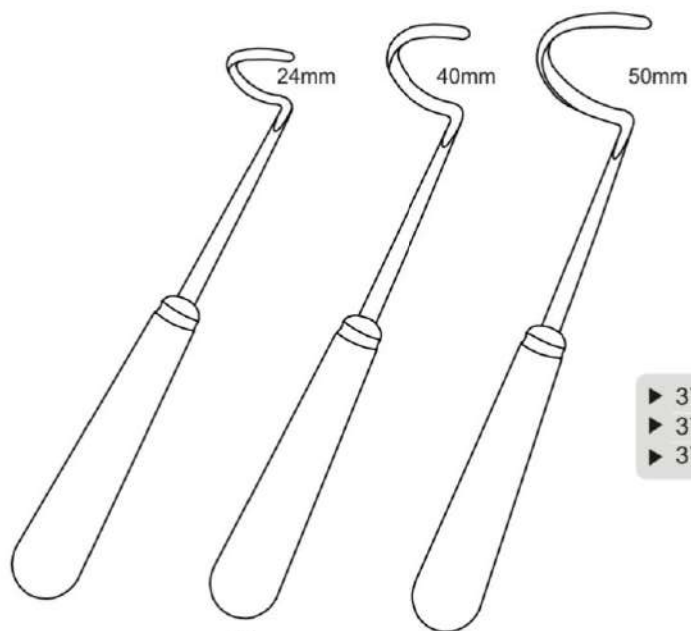

▶ 37-3301	24.0cm	24mm
▶ 37-3302	24.2cm	40mm
▶ 37-3303	24.4cm	50mm

$\frac{1}{2}$   
with artificial wood handle

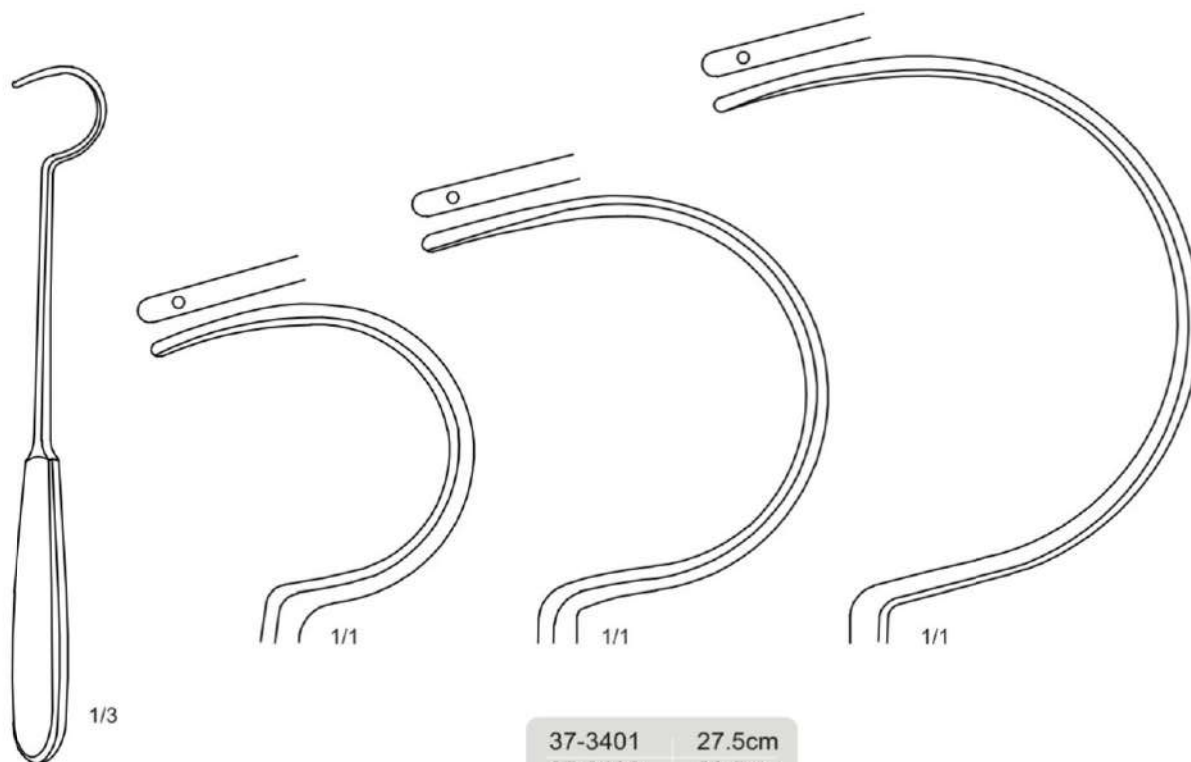

**DEMEL**

37-3401	27.5cm
37-3402	28.5cm
37-3403	30.5cm

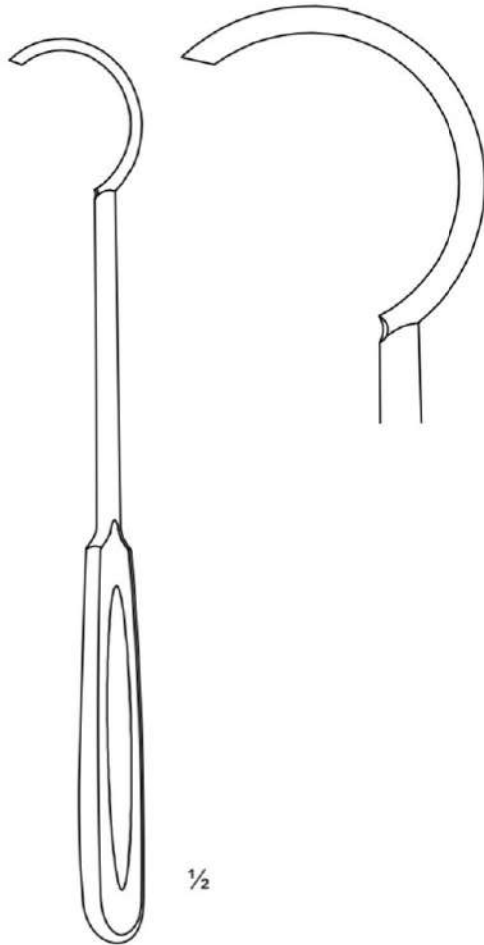

▶ 37-3501	24.0cm	Hollow/Sharp
▶ 37-3502	27.0cm	Hollow/Sharp

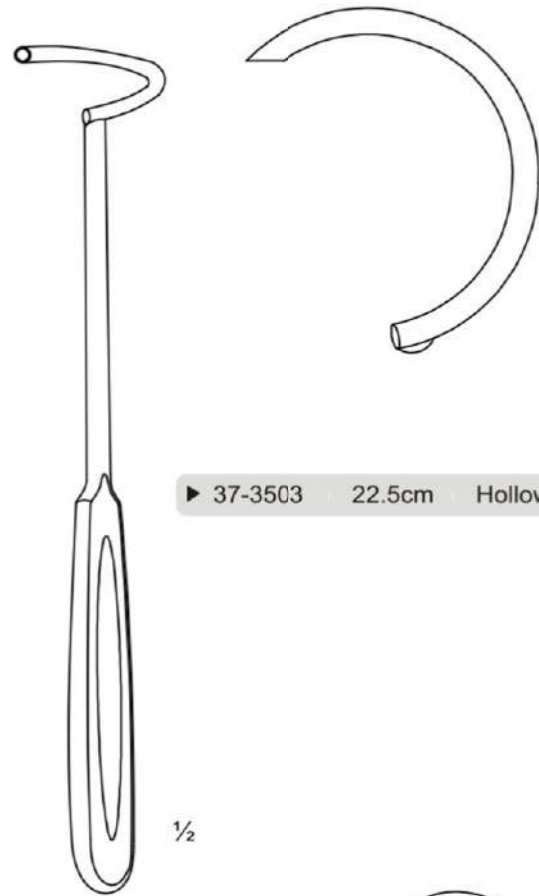

▶ 37-3503 22.5cm Hollow/Sharp

1/2

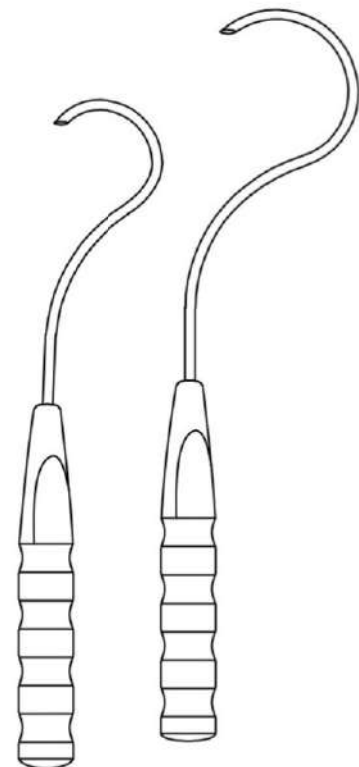

▶ 37-3601	25.0cm	ø 45mm
▶ 37-3602	28.0cm	ø 63mm

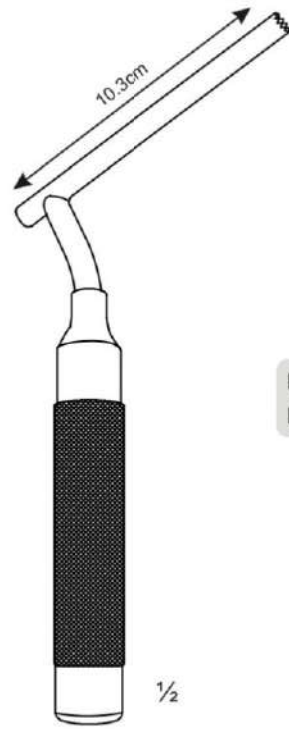

Trephine Guide

▶ 37-4001	19.7cm	ø 5.3mm
▶ 37-4002	20.0cm	ø 8.3mm

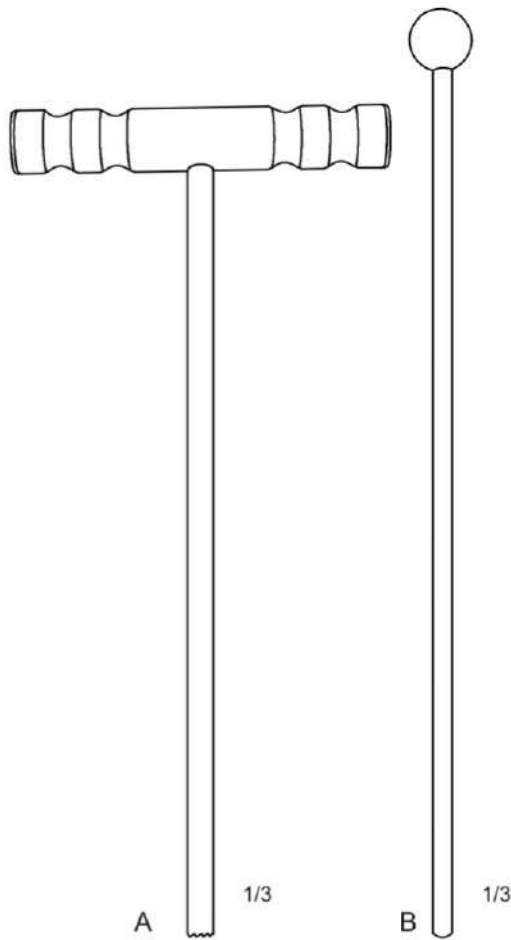

A Bone Biopsy Trephine

B Pusher

▶ 37-4000	SET	
▶ 37-4010	A 19.0cm	ø 2.7mm
	B 21.0cm	ø 2.0mm
▶ 37-4020	A 25.0cm	ø 4.8mm
	B 29.0cm	ø 3.2mm
▶ 37-4030	A 25.0cm	ø 8.0mm
	B 29.0cm	ø 5.5mm



Fig. 4



Fig. 3



Fig. 2

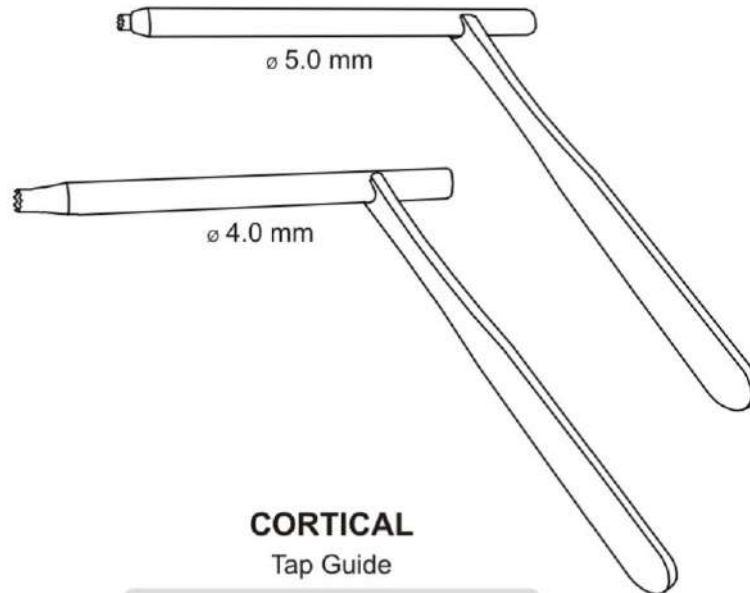

Fig. 1

**AUTOBONE BIOPSY SET**

Auto bone biopsy used with automatical drill

▶ 37-4100	SET		
▶ 37-4101	25.0cm	pusher	Fig. 1
▶ 37-4110	25.0cm	∅ 8.0mm	Fig. 2
▶ 37-4120	25.0cm	∅ 10.0mm	Fig. 3
▶ 37-4130	25.0cm	∅ 12.5mm	Fig. 4



**CORTICAL**

Tap Guide

▶ 37-4201	25.0cm	∅ 4.0mm
▶ 37-4202	25.0cm	∅ 5.0mm



# Wire Holding Pliers

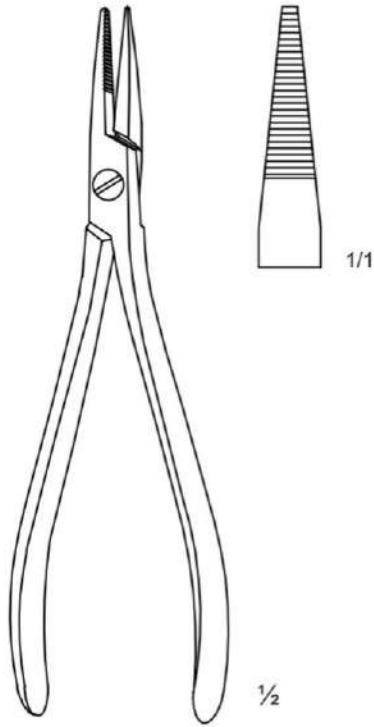

37-4300 19.0cm

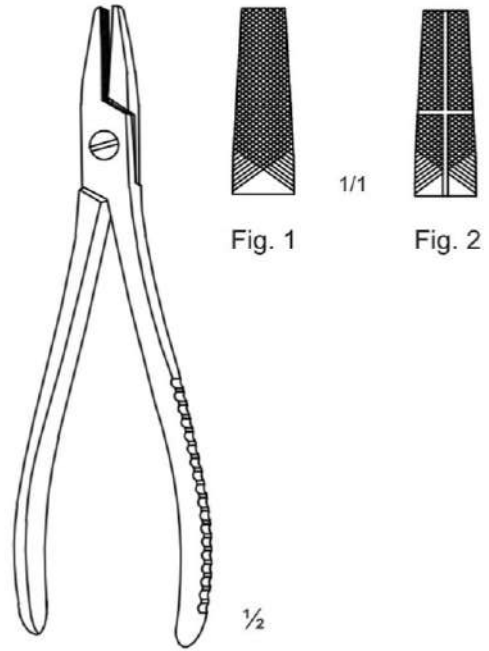

37-4401 Fig. 1  
37-4402 Fig. 2

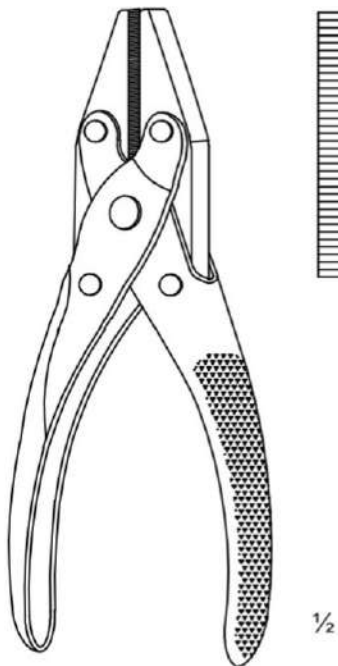

37-4500 17.0cm

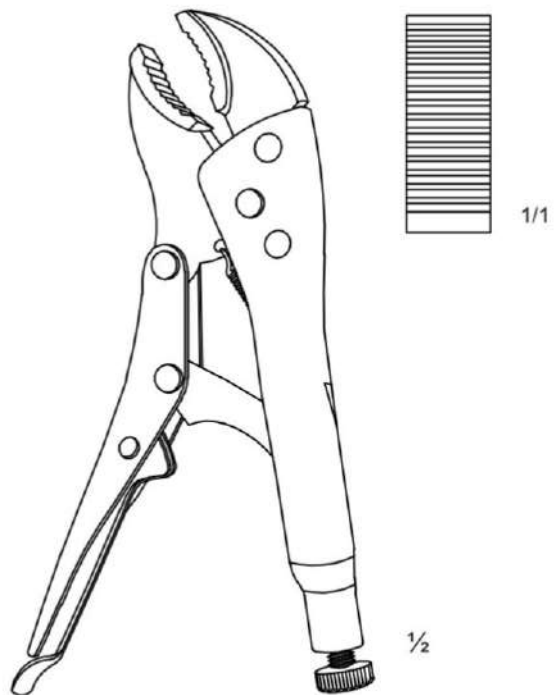

37-4600 20.0cm



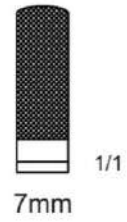
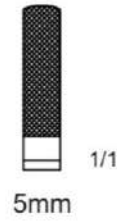
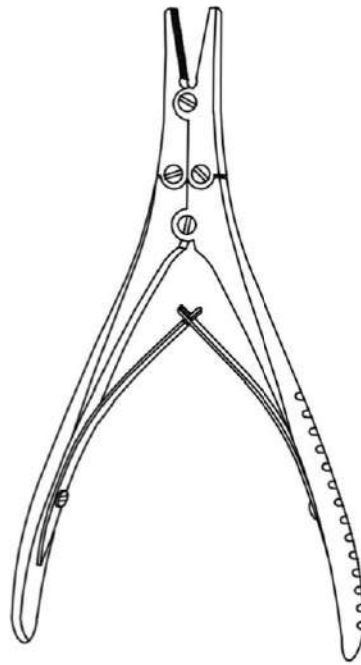

37-4701	5mm
37-4702	7mm

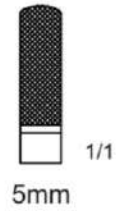
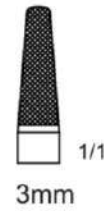
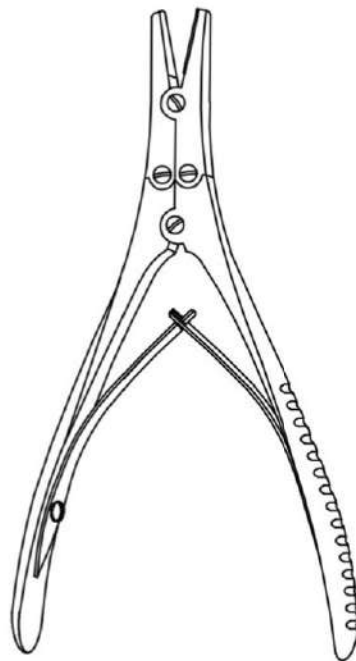

37-4801	1mm
37-4802	3mm
37-4803	5mm
37-4804	6mm

T-C Tips Inserted

# Wire Cutting Pliers TC

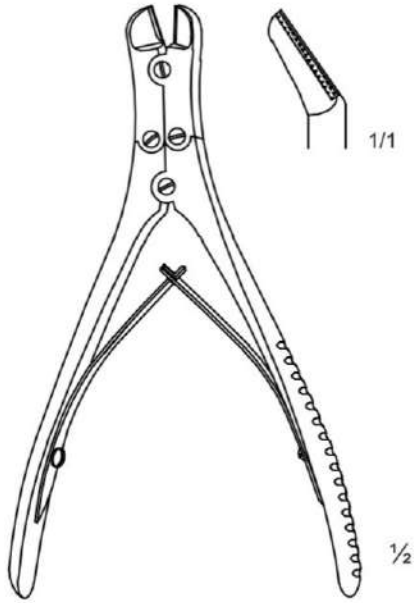

37-4901 18.0cm

For soft wire up to 2.0mm  
For hand wire up to 1.7mm

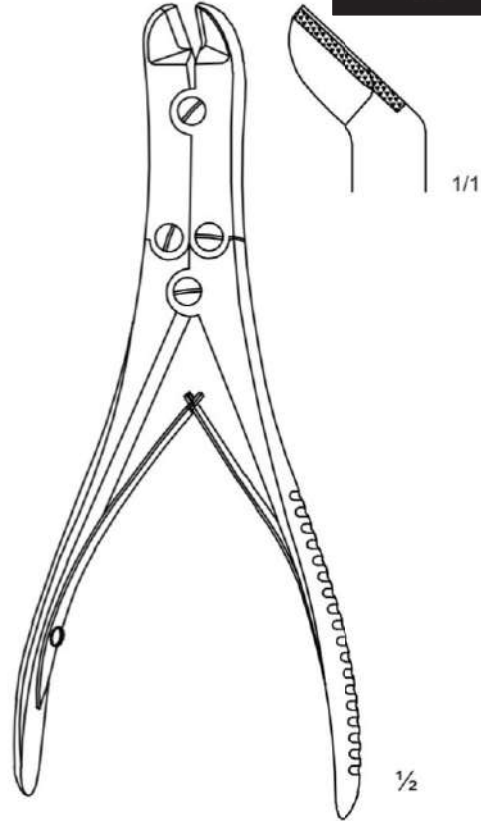

37-4902 22.0cm

For soft wire up to 3.0mm  
For hand wire up to 2.5mm

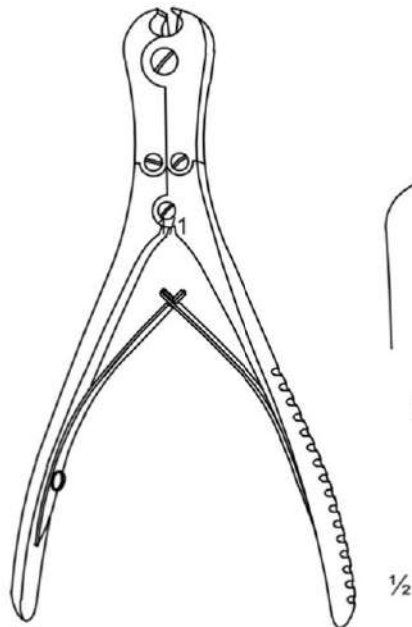

37-5000 18.0cm

For hand wire up to 1.7mm

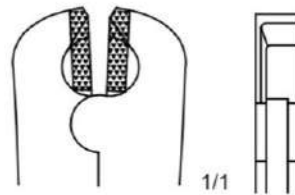

Side & End Cutting

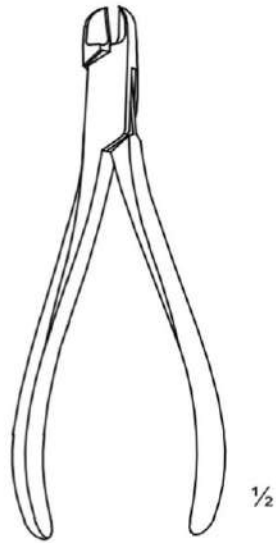

37-5100 14.0cm  
For hand wire up to 0.6mm

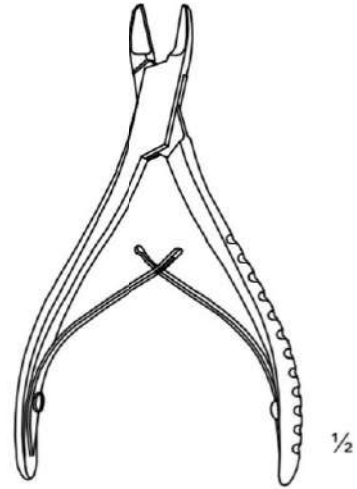

37-5200 12.5cm  
For hand wire up to 0.6mm

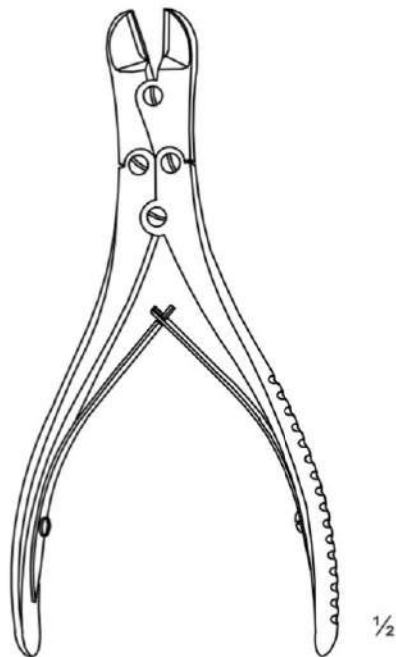

37-5301 16.0cm  
For hand wire up to 1.6mm

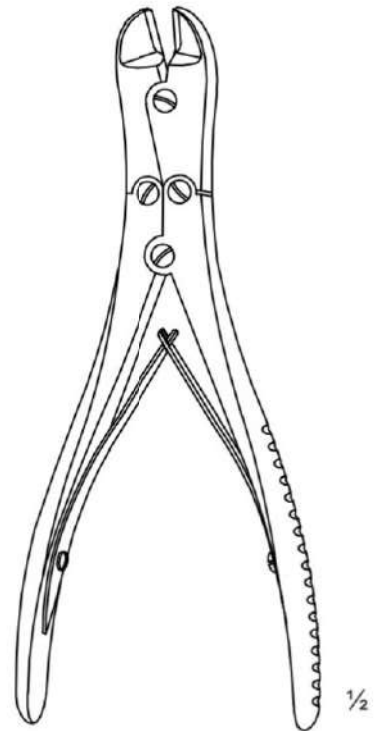

37-5302 18.0cm  
For hand wire up to 1.6mm

# Wire Cutting Pliers

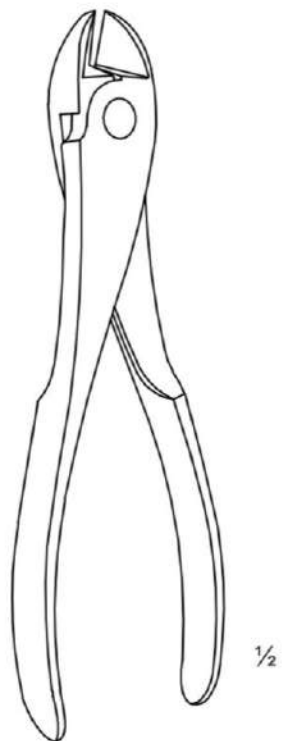

37-5401 18.5cm

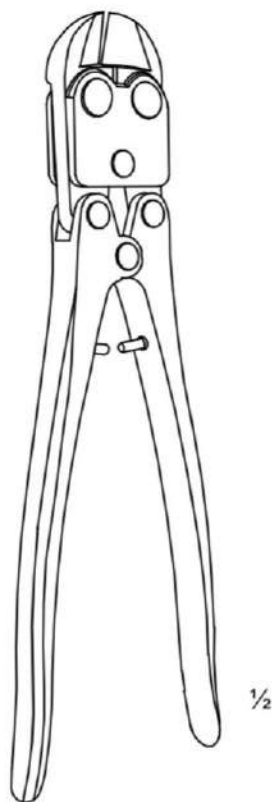

37-5402 21.5cm

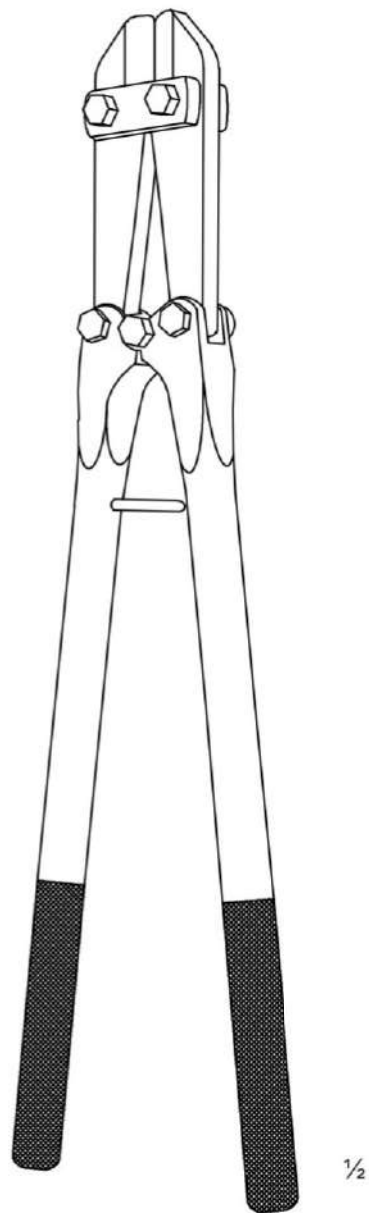

37-5410 47.0cm  
37-5420 54.0cm

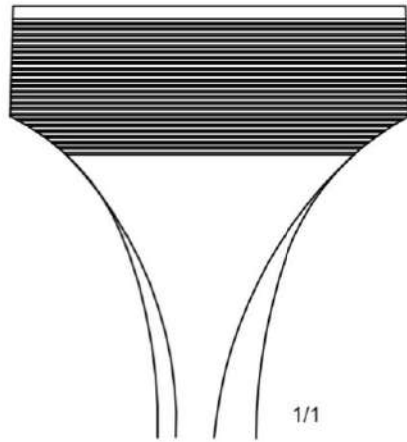

1/1

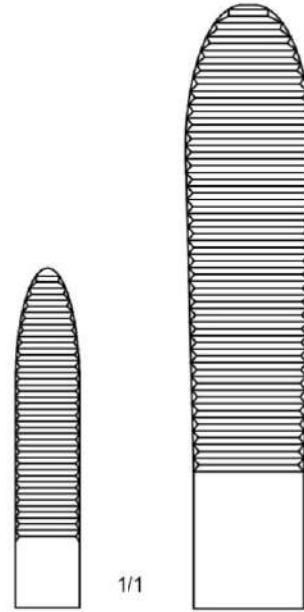

1/1

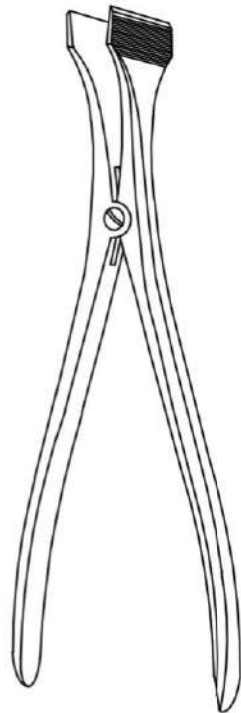

1/3

**HENNIG**  
Plaster Sprader

▶ 37-5500 28.0cm

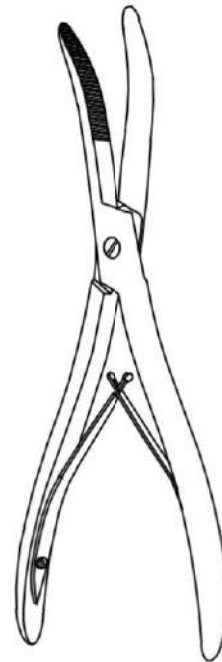

1/3

**WOLFF**  
Plaster Breakers

37-5601	18.0cm
37-5602	24.0cm

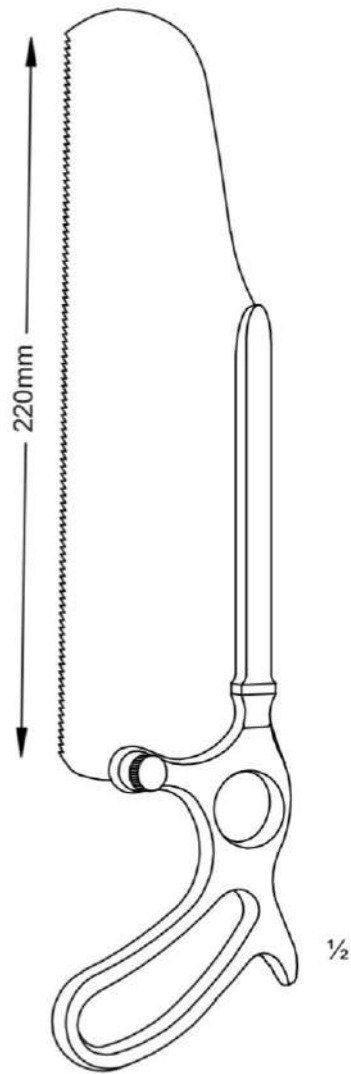
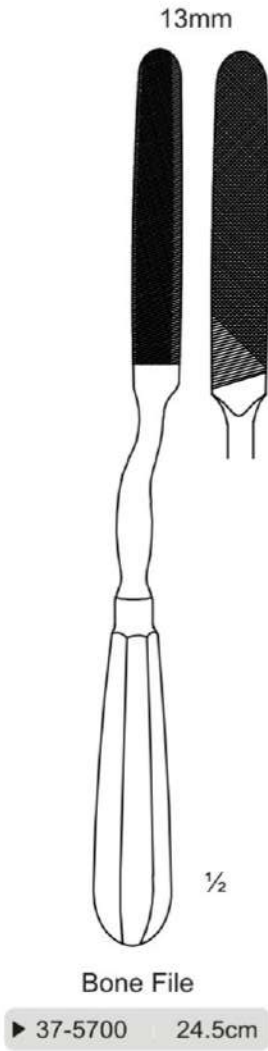

**SATTERLEE**  
Saw

▶ 37-5800 29.0cm

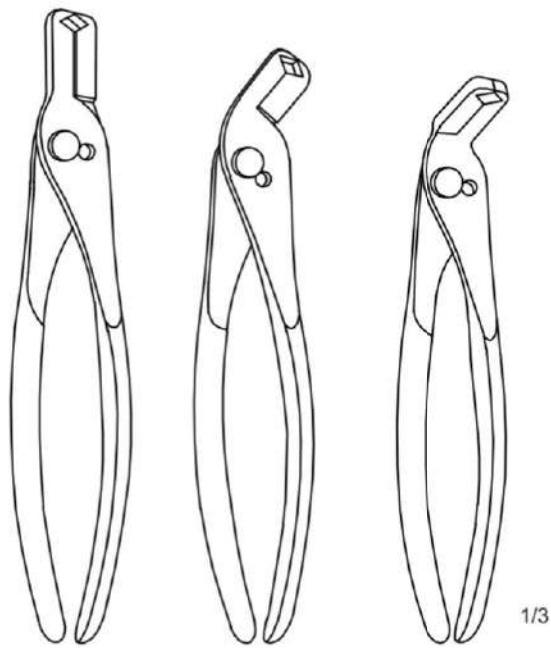

**Rib Stapple Plier**

- |           |        |                |
|-----------|--------|----------------|
| ▶ 37-5901 | 26.0cm | Straight       |
| ▶ 37-5902 | 25.0cm | Curved To Side |
| ▶ 37-5903 | 23.0cm | Angled Up      |



▶ 37-6001	1.8 x 4.5mm	35°	Knife	Fig.1
▶ 37-6002	1.8 x 3.3mm	35°	Knife	Fig.2
▶ 37-6003	2.0 x 3.0mm	45°	Curette	Fig.3
▶ 37-6004	2.0 x 3.0mm	90°	Curette	Fig.4
▶ 37-6010	1.8 x 4.5mm	35°	Handle	Fig.5

▶ 37-6101	5mm
▶ 37-6102	8mm

**Fig.5**  
Disk Set

**LEE'S**  
Dissector

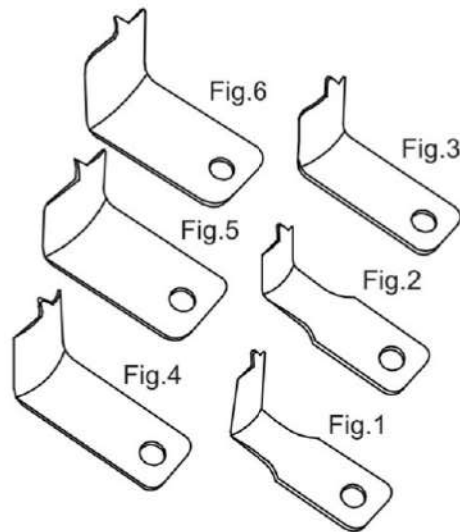

**TAYLOR**  
Retractors

▶ 37-6201	20.5 x 53.5mm	Fig.1
▶ 37-6202	21.0 x 44.0mm	Fig.2
▶ 37-6203	30.0 x 54.0mm	Fig.3
▶ 37-6204	31.0 x 64.0mm	Fig.4
▶ 37-6205	40.0 x 53.0mm	Fig.5
▶ 37-6206	40.0 x 63.0mm	Fig.6



**LEE'S**

▶ 15-3411	6mm
▶ 15-3412	8mm





**Neurology Surgery**  
Neurology Surgery

The section header is centered on the page. It consists of two lines of text. The top line, "Neurology Surgery", is in a bold, orange, sans-serif font. The bottom line, "Neurology Surgery", is in a grey, sans-serif font. To the right of the text is a line-art illustration of a pair of long-handled surgical forceps, oriented horizontally. Below the text, there is a decorative horizontal line composed of a series of small, grey dots.

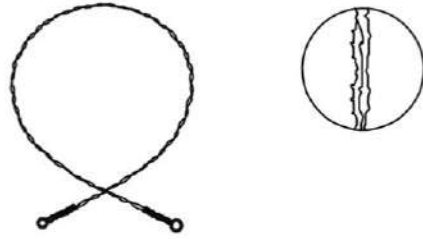

**GIGLI**  
Saws

▶ 38-0101	30.0cm
▶ 38-0102	40.0cm
▶ 38-0103	50.0cm

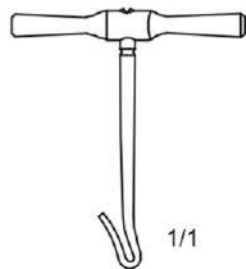

Gigli Saw  
Handle

▶ 38-0109



**DE MARTEL**  
Gigli Saw Conductor

▶ 38-0108 33.0cm

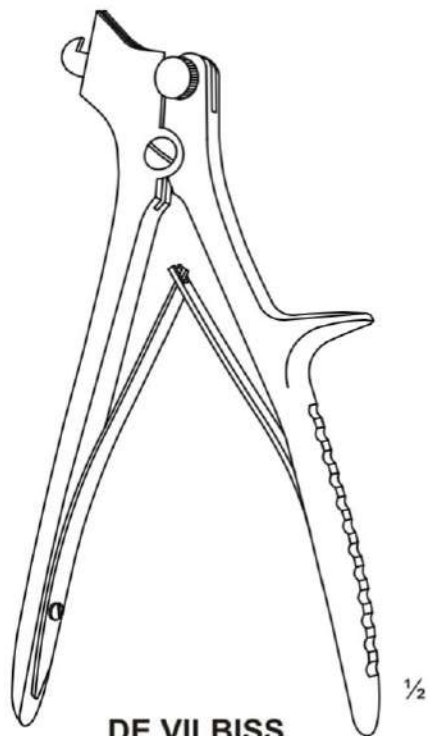

**DE VILBISS**  
Cranial Rongeur

▶ 38-0201 20.5cm

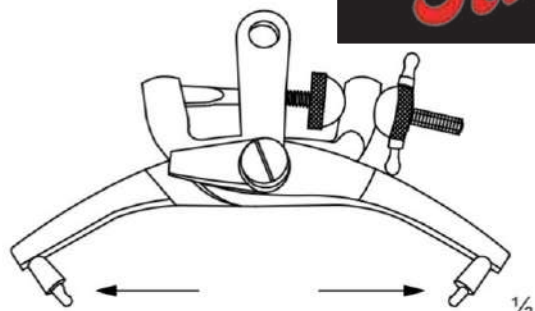

**CRUTCHFIELD**  
Skull Traction

▶ 38-0210

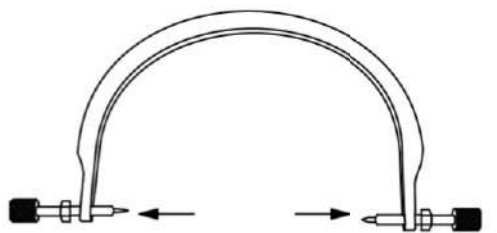

**HEAD TRACTION**

▶ 38-0220 22.0cm

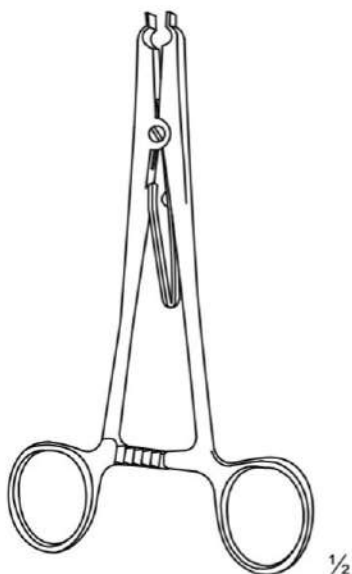

**RANEY**

▶ 38-0300 16.0cm

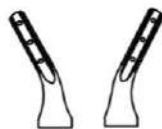

Ø 7mm



**YASARGIL**  
Galea Hook

▶ 17-3701

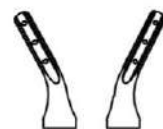

Ø 9mm



**YASARGIL**  
Galea Hook

▶ 17-3702

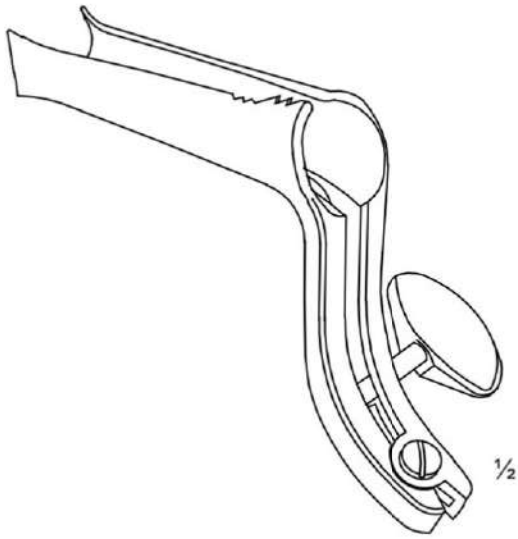

**CUSHING-LANDOLT**  
Specula for Trans-sphenoidal  
Hypophysectomy

38-0401	70 x 15mm
38-0402	90 x 15mm
38-0403	110 x 15mm

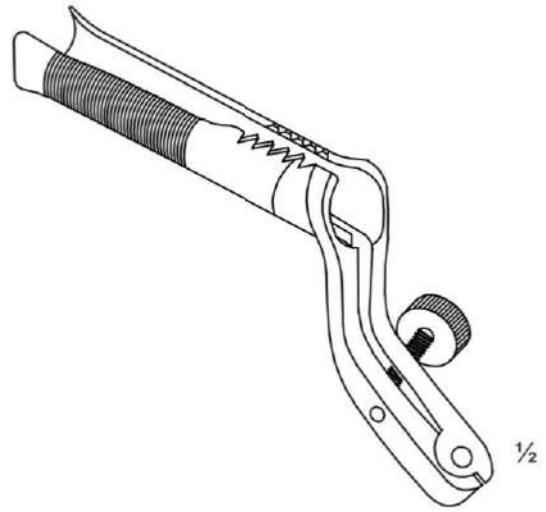

**PAPAVERO-CASPAR**  
Specula for Trans-sphenoidal  
Hypophysectomy

38-0404	80 x 11mm
38-0405	90 x 13mm
38-0406	100 x 15mm

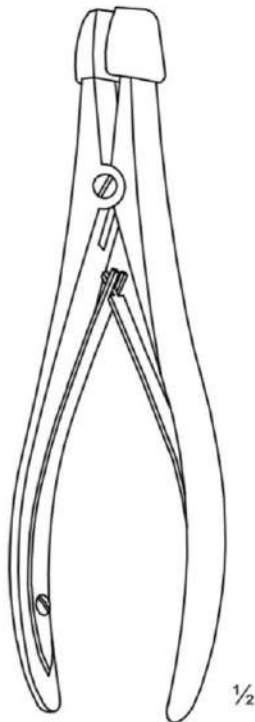

**LANDOLT**  
Spreader for Specula

38-0500	21.0cm
---------	--------

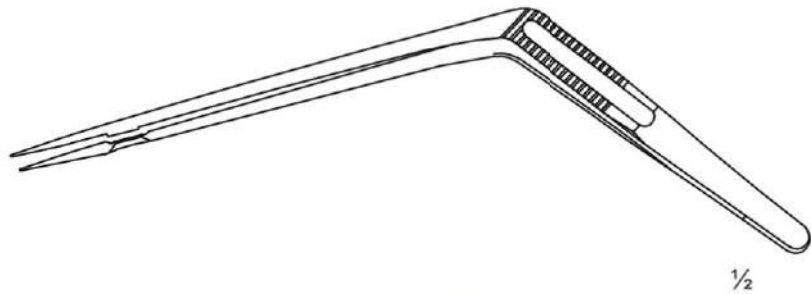

**LANDOLT**  
Forceps

38-0600	21.0cm
---------	--------

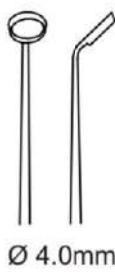

38-0701 | Horizontal 45°



38-0702 | Vertical 45°

**RAY**  
Curettes

1/1

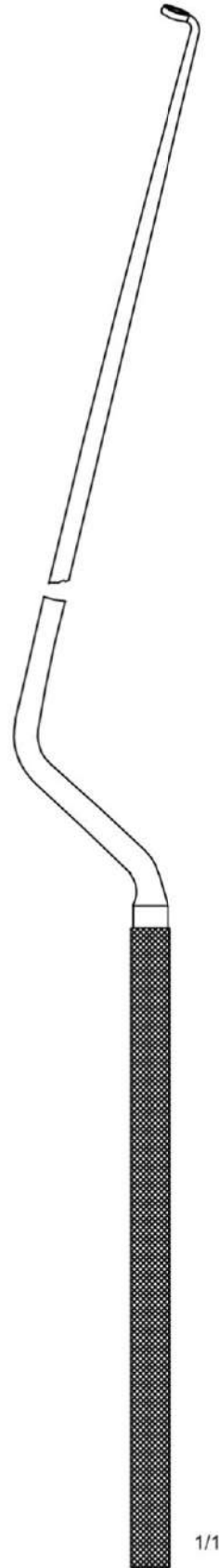

38-0703 | Malleable

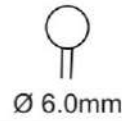

38-0704 | Malleable

**HARDY**  
Curettes

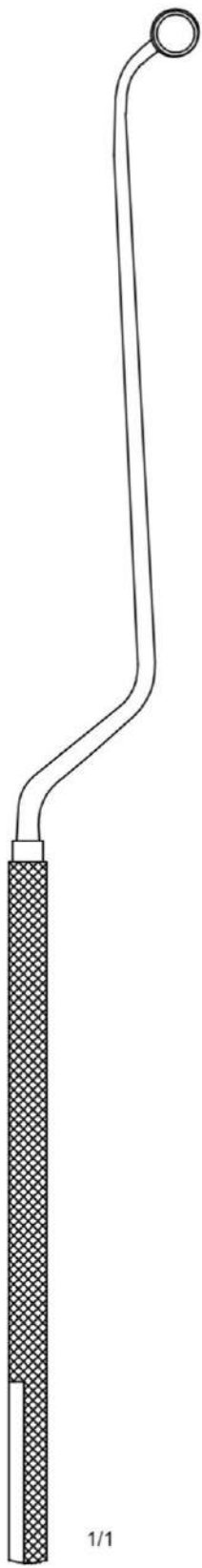

**NICOLA**  
Currettes



Ø 6.5mm

38-0705 Malleable, Cutting to the Right



Ø 6.5mm

38-0706 Malleable, Cutting to the left



Ø 6.5mm

38-0707 Malleable

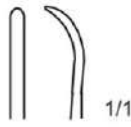

1/1

38-0801 Raspatory





YASARGIL



38-0804 | 18.5cm

1/1

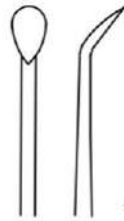

38-0805 | 18.5cm

1/1



38-0806 | 18.5cm

1/1



38-0807 | 18.5cm

1/1

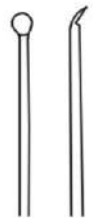

38-0808 | 23.0cm

1/1

Round Blade

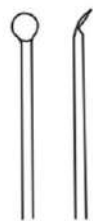

38-0809 | 23.0cm

1/1

Round Blade

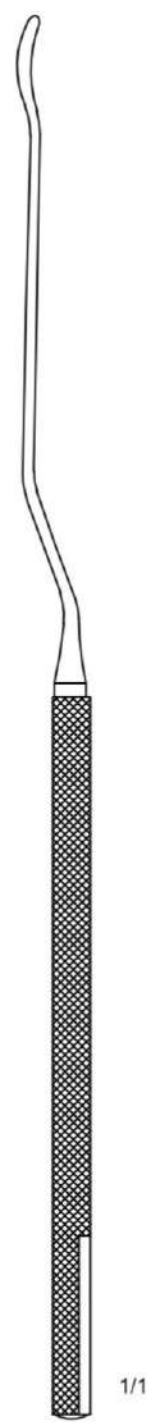

YASARGIL

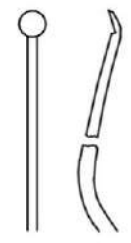

38-0810 | 23.0cm

1/1

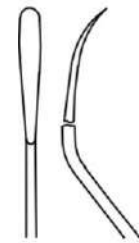

38-0811 | 18.5cm

1/1

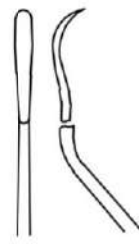

38-0812 | 18.5cm

1/1

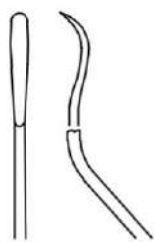

38-0813 | 18.5cm

1/1

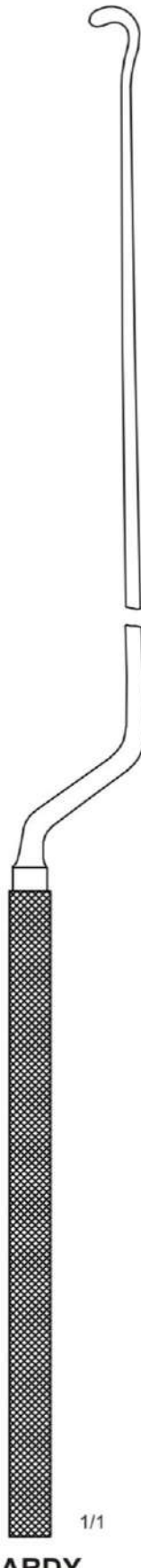

HARDY



1/1

**HARDY**  
Enucleator  
Blunt

38-0901	Right
38-0911	Left



1/1

**HARDY**  
Enucleator  
Blunt

38-0902	Right
38-0912	Left



1/1

**HARDY**  
Enucleator  
Sharp

38-0903	Right
38-0913	Left



1/1

**HARDY**  
Enucleator  
Sharp

38-0904	Right
38-0914	Left



1/1

**HARDY**  
Implant Fork

38-1001



1/1

**HARDY-FAHLBUSCH**  
Dissector Sharpened  
Inner edge

38-1101



1/1

**HARDY-FAHLBUSCH**  
Dissector Sharpened  
Inner edge

38-1102

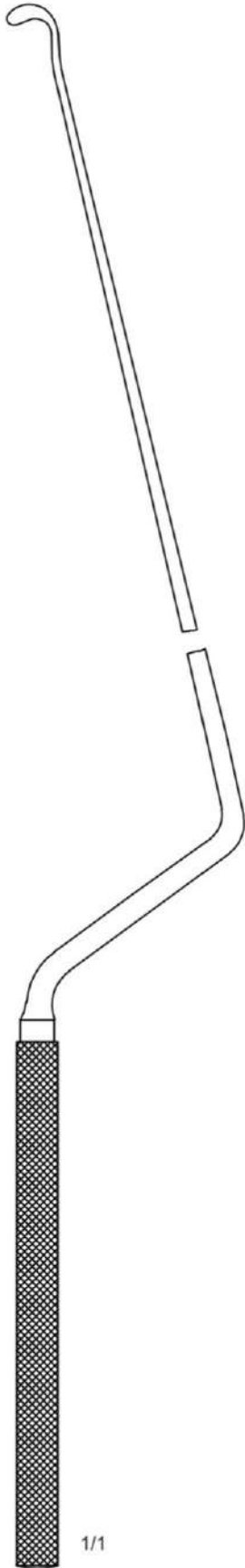

LANDOLT

1/1



**LANDOLT**  
Enucleator  
Blunt  
Malleable

38-0905 Right  
38-0915 Left



**LANDOLT**  
Enucleator  
Blunt  
Malleable

38-0906 Right  
38-0916 Left

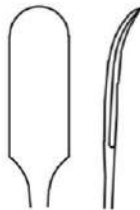

**LANDOLT**  
Curette  
Malleable

38-0708

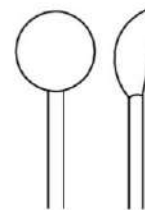

**LANDOLT**  
Scoop  
Malleable

38-1201



**LANDOLT**  
Blunt Hook  
Malleable

38-1301

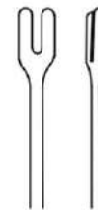

**LANDOLT**  
Fork Spatula  
Rigid

38-1002

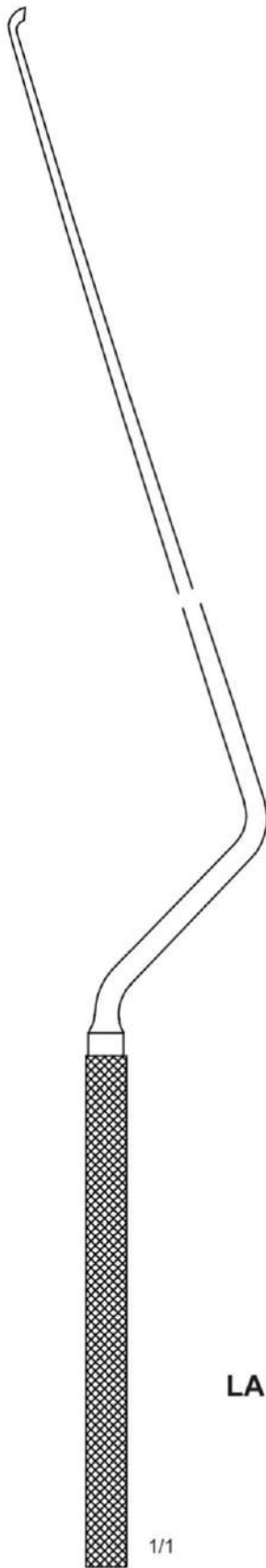

**FAHLBUSCH**



1/1

**FAHLBUSCH**

Scoop  
Malleable

38-1202

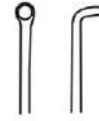

ø 2.5mm

**FAHLBUSCH**

Curette  
Malleable

38-0709

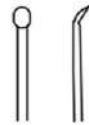

ø 2.2mm

**LANDOLT-REULEN**

Raspatory  
Rigid

38-0802

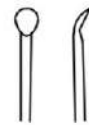

ø 3.2mm

**LANDOLT-REULEN**

Raspatory  
Rigid

38-0803



ø 2.5mm

**LANDOLT-REULEN**

Curette  
Rigid

38-0710



ø 1.7mm

**LANDOLT-REULEN**

Blunt Hook  
Rigid

38-1302



ø 2.0mm

**LANDOLT-REULEN**

Dissector  
Rigid

38-1103

1/1



1/1

**JACOBSON**  
Micro Vessel Knife  
38-1401 | 18.5cm



1/1



1/1

**JACOBSON**  
Vessel Knife  
38-1402 | 9.5cm



1/1

Handle with Chuck  
38-1700 | Only Handle



1/1

Hook  
38-1303 | 8.5cm

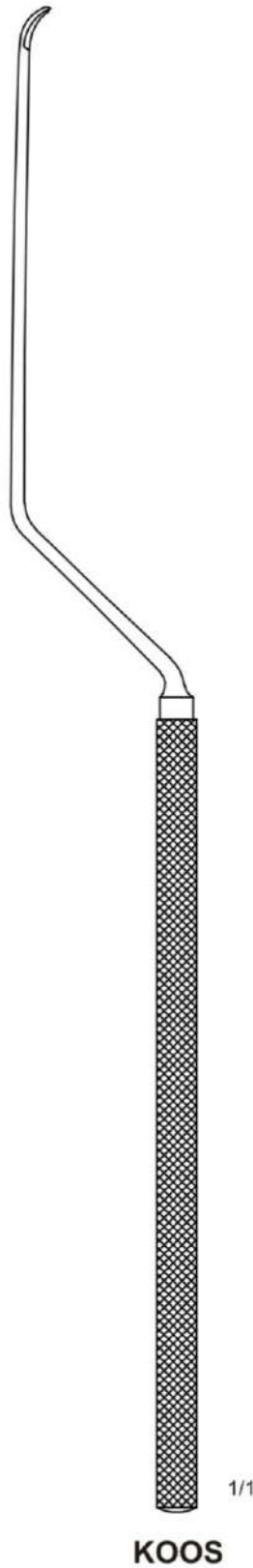

**KOOS**

1/1



1/1

**KOOS**

38-1403



1/1

**KOOS**

38-1404



1/1

**KOOS**

38-1405



1/1

**KOOS**

38-1406



1/1

**KOOS**

38-1407



1/1

**KOOS**

38-1408



1/1

**YASARGIL**

38-1409



1/1

**YASARGIL**

38-1410





1/1

**SAMII**

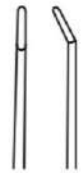

1.0mm



1.5mm



2.0mm



2.5mm



3.0mm



3.5mm



4.0mm



5.0mm

38-1501	20.0cm	1.0mm	38-1521	23.0cm	1.0mm
38-1502	20.0cm	1.5mm	38-1522	23.0cm	1.5mm
38-1503	20.0cm	2.0mm	38-1523	23.0cm	2.0mm
38-1504	20.0cm	2.5mm	38-1524	23.0cm	2.5mm
38-1505	20.0cm	3.0mm	38-1525	23.0cm	3.0mm
38-1506	20.0cm	3.5mm	38-1526	23.0cm	3.5mm
38-1507	20.0cm	4.0mm	38-1527	23.0cm	4.0mm
38-1508	20.0cm	5.0mm	38-1528	23.0cm	5.0mm



1/1

**SAMII**

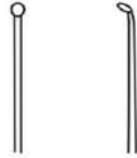

∅ 1.5mm

38-1509	20.0cm
38-1529	23.0cm

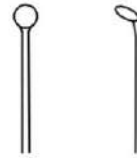

∅ 3.0mm

38-1510	20.0cm
38-1530	23.0cm

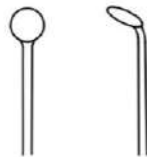

∅ 4.5mm

38-1511	20.0cm
38-1531	23.0cm

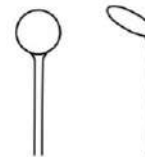

∅ 6.0mm

38-1512	20.0cm
38-1532	23.0cm



1.8mm  
Lancet Knives

38-1601	23.0cm
---------	--------



2.5mm  
Lancet Knives

38-1602	23.0cm
---------	--------



1/1

OKONEK-YASARGIL



3.0mm  
38-1010



4.0mm  
38-1020



5.0mm  
38-1030



8.0mm  
38-1040



CASPAR 1/1

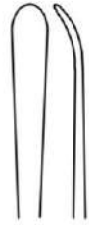

CASPAR  
4.5mm

38-1104 23.0cm



CASPAR  
1.0mm

38-1105 20.0cm

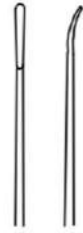

1/1

38-1106 23.0cm

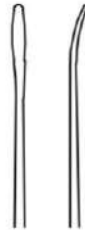

1/1

38-1107 23.0cm



1/1

38-1108 23.0cm



3.0mm

38-1109 18.5cm



3.0mm

38-1110 21.5cm



1/1

YASARGIL

38-1111 18.5cm

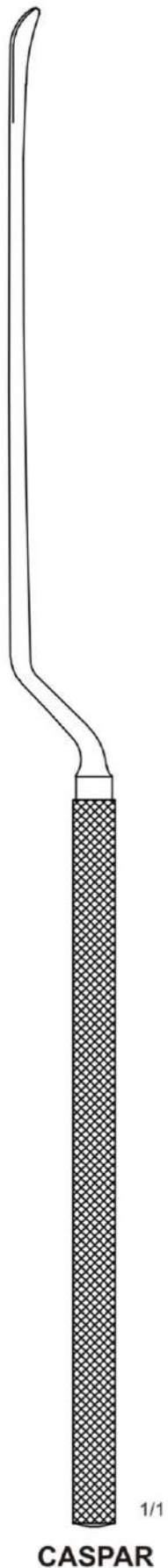

**CASPAR**  
4.5mm  
38-1112 23.0cm

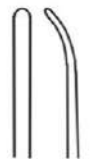

**CASPAR**  
2.0mm  
38-1113 23.0cm



**CASPAR**  
1.0mm  
38-1114 21.0cm

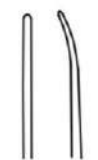

**CASPAR**  
1.0mm  
38-1115 21.0cm

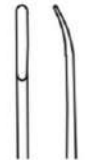

**CASPAR**  
1.0mm  
38-1116 23.0cm



**CASPAR**  
1.0mm  
38-1117 23.0cm

**CASPAR**  
1/1



1/1

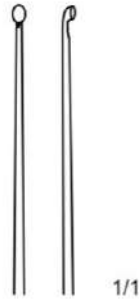

1/1

Straight

38-1203 23.0cm

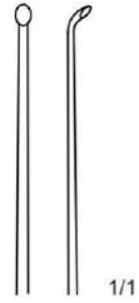

1/1

Curved up

38-1204 23.0cm

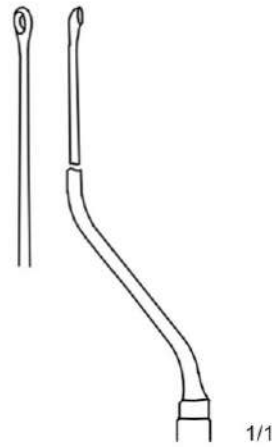

1/1

YASARGIL

38-1205 18.5cm



1/1



1/1

Sharp

38-1304 23.0cm



1/1

Blunt

38-1305 23.0cm



90°

1/1

Sharp, Curved

38-1306 18.5cm



90°

1/1

FISCH

Sharp, Angled

38-1307 18.5cm





**BIEMER**

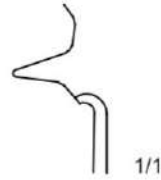

**BIEMER**  
Vessel Spreader  
38-1801 16.0cm

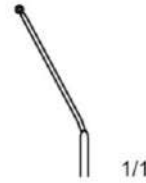

Vessel Dilator  
Ø 0.5mm  
38-1802 12.5cm

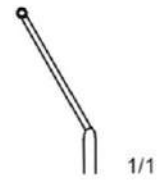

Vessel Dilator  
Ø 1.0mm  
38-1803 12.5cm



Vessel Dilator  
Ø 1.5mm  
38-1804 12.5cm



**JACOBSON**  
Probe with Ball Tip  
38-1805 18.5cm



**JACOBSON**  
Vessel Probe  
38-1806 18.5cm

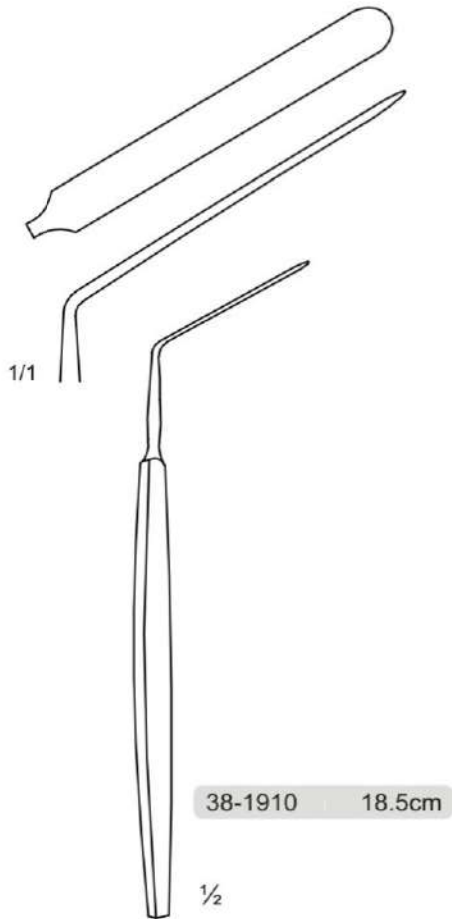

HORSLEY

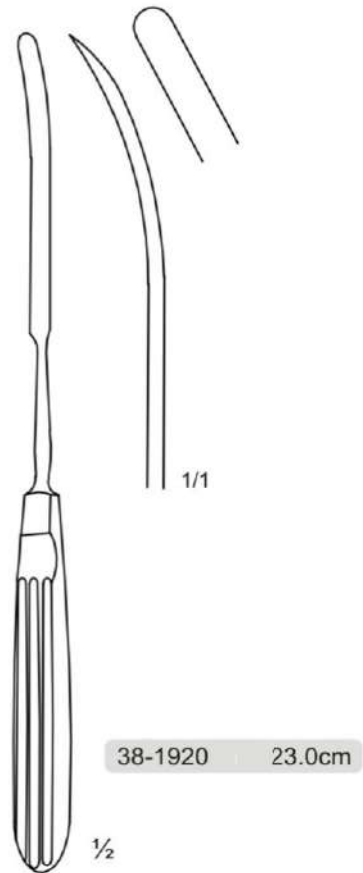

SACHS

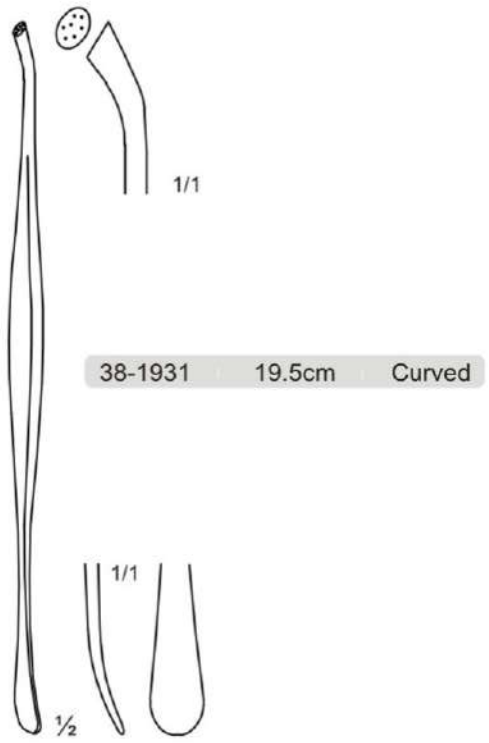

PENFIELD

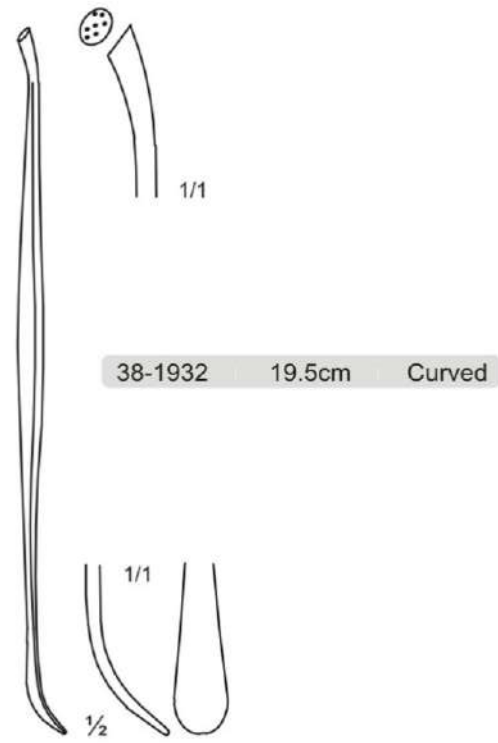

PENFIELD

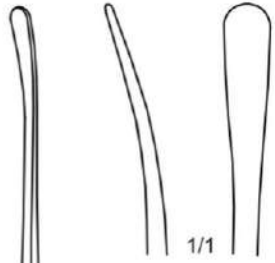

38-1940 | 29.0cm

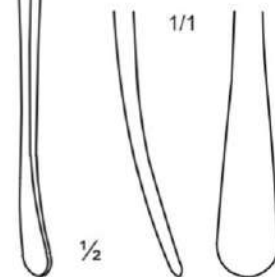

PENFIELD

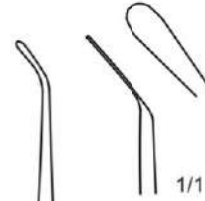

38-1950 | 21.0cm

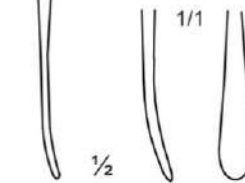

MILLIGAN

# Nerve Retractors

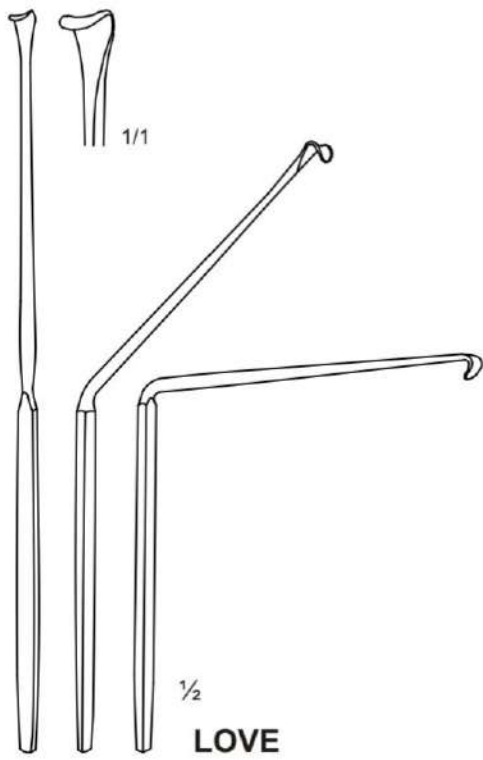

▶ 15-3001	22.0cm	STR
▶ 15-3002	22.0cm	45° ANGLED
▶ 15-3003	22.0cm	90° ANGLED

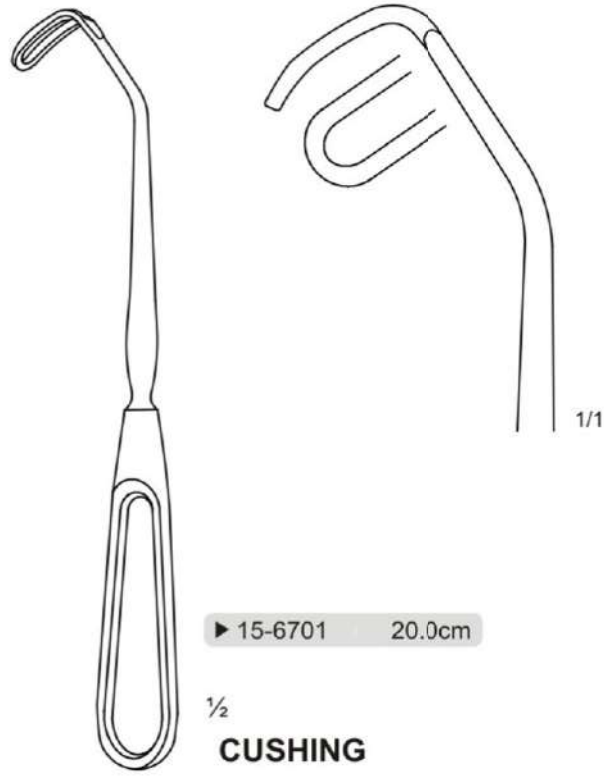

▶ 15-6701 20.0cm

1/2  
**CUSHING**

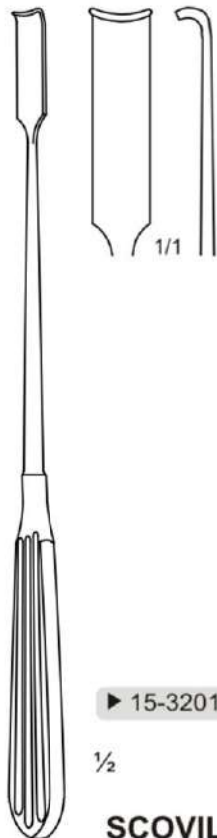

▶ 15-3201 23.0cm Straight

1/2  
**SCOVILLE**

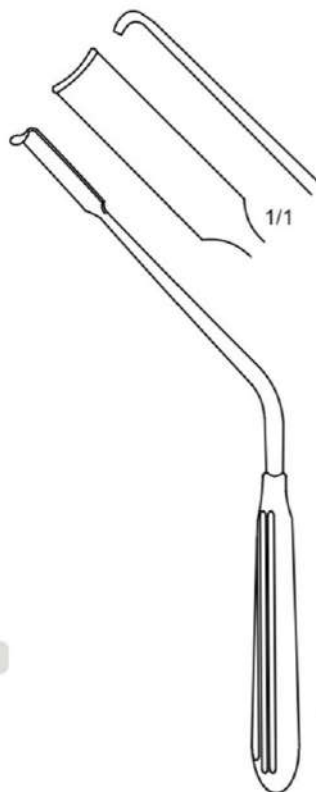

▶ 15-3211 22.0cm Curved

1/2  
**SCOVILLE**



**ROOT**

- ▶ 15-3300 23.0cm 6mm BLADE

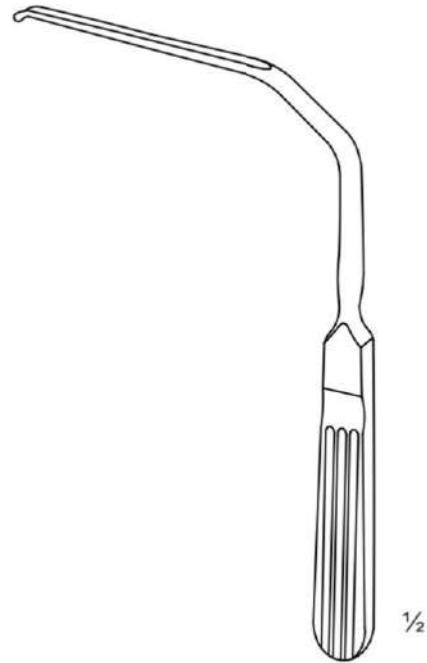

**DURA**

- ▶ 15-3101 18.0cm 3 x 10mm
- ▶ 15-3102 18.0cm 4 x 10mm
- ▶ 15-3103 18.0cm 5 x 10mm
- ▶ 15-3104 18.0cm 7 x 10mm

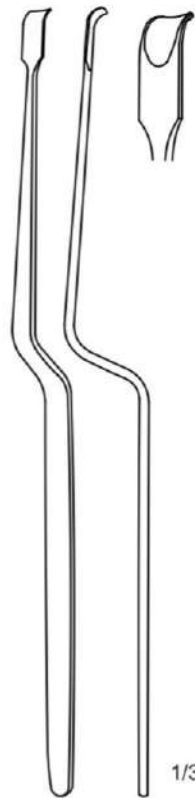

**D'ERRICO**

- ▶ 15-3500 23.0cm Bayonet Style

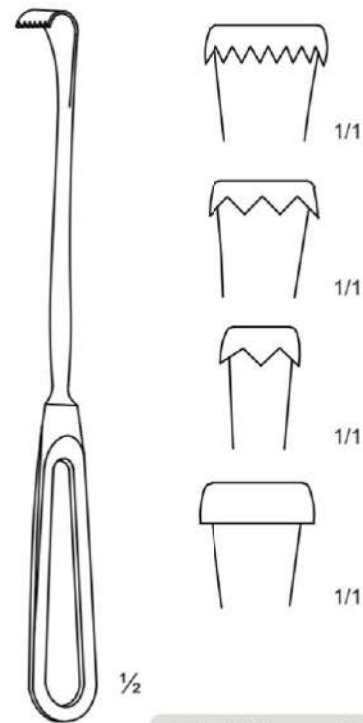

**OLDBERG**

- ▶ 38-2001 8 Teeth on Blade
- ▶ 38-2002 4 Teeth on Blade
- ▶ 38-2003 3 Teeth on Blade
- ▶ 38-2004 Flat Blade

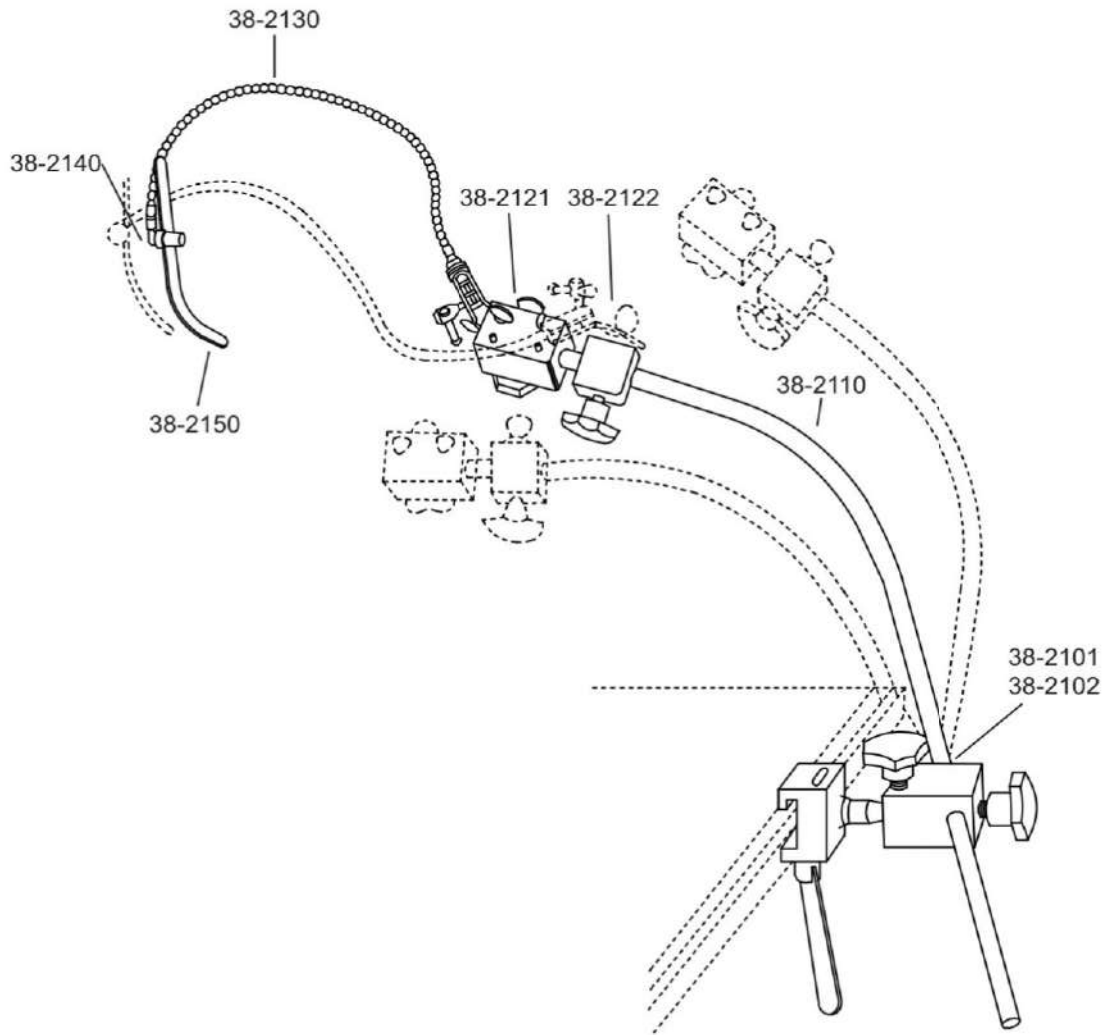

YASARGIL

38-2101	Ball and socket joint for fixation on operating table 10 x 25mm, alternative to 38-2102
38-2102	Ball and socket joint for fixation on operating table 9 x 32mm, alternative to 38-2101
38-2110	Hording rod for fixation
38-2121	Coupling head for 5 flexible arms max.
38-2122	Coupling head, turnable, alternative to 38-2121
38-2123	Coupling head, laterally open, alternative to 38-2121
38-2130	Flexible arm
38-2140	Holder for flat blain spatula
38-2150	Brain spatula



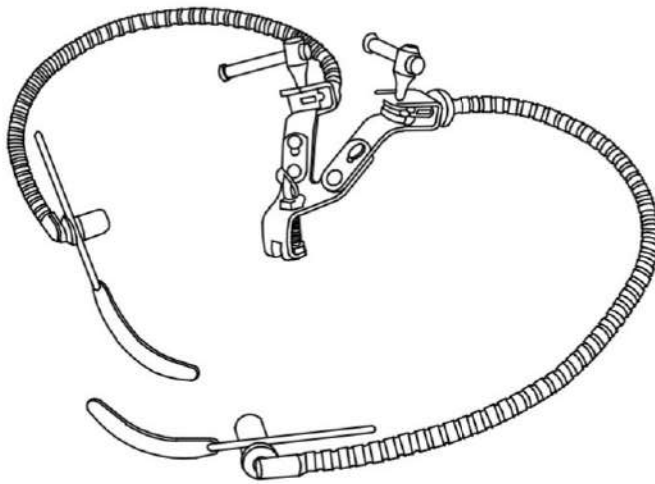

38-2103 Brain retractor, flexible, for flat spatula, with 1 flexible arm, complete.

Consist of : 38-2144 Fixation base for 1 flexible arm  
38-2130 Flexible arm only  
38-2140 Support for flat brain spatulas

38-2104 Brain retractor, flexible, for flat spatulas, with 2 flexible arm, complete.

Consist of : 38-2142 Fixation base for 2 flexible arms  
38-2130 Flexible arm only (2x)  
38-2140 Support for flat brain spatulas(2x)

**YASARGIL**

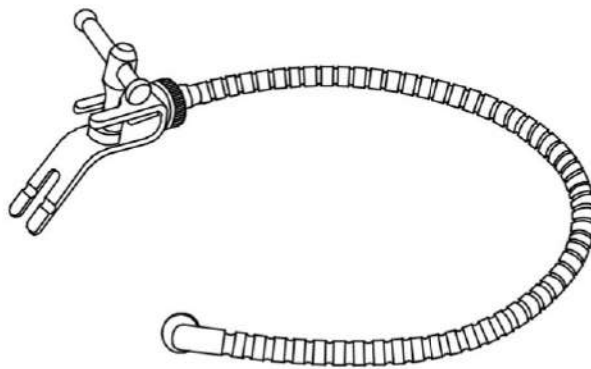

38-2130 Flexible arm only

**YASARGIL**

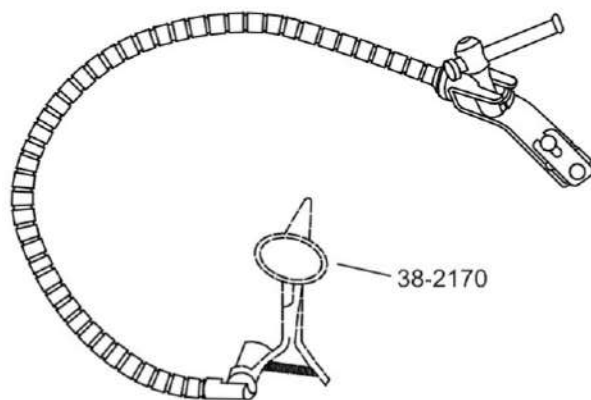

38-2105 Ear specula holder complete

Consist of : 38-2130 Flexible arm only  
38-2144 Clamp for fixation on bars up to Ø 16mm  
38-2170 Ear specula holder only

**YASARGIL**





38-2140 Support for flat brain spatula

38-2141 Support for brain spatula with round shaft



38-2142 Fixation for 2 arms at skull

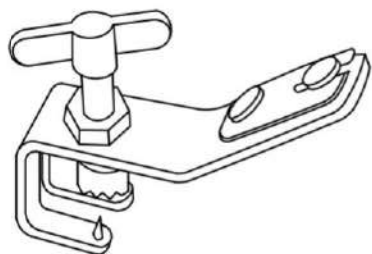

38-2143 Fixation for 1 arm at skull

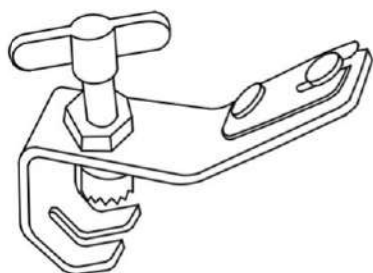

38-2144 Fixation base for 1 arm on bars up to Ø 16mm

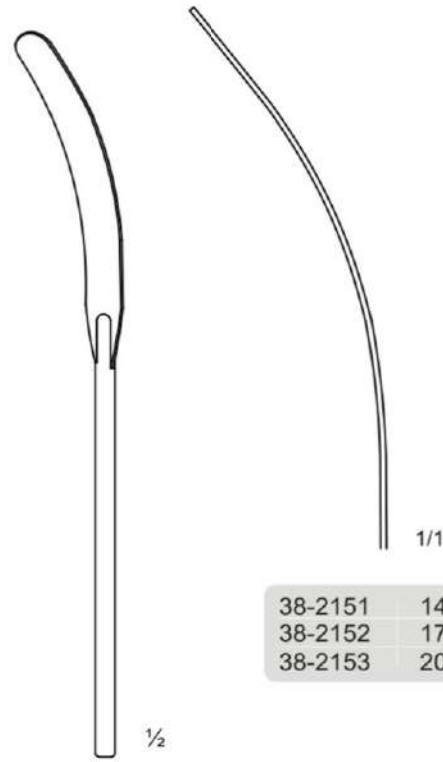

**Malleable**

38-2151	14mm
38-2152	17mm
38-2153	20mm



**HEIFETZ**  
Malleable

38-2181	8mm
38-2182	11mm
38-2183	14mm
38-2184	17mm



**CUSHING**

38-2157	18.0cm	7 x 9mm
38-2158	20.0cm	11 x 13mm
38-2159	20.0cm	15 x 18mm



Fig.1



Fig.2

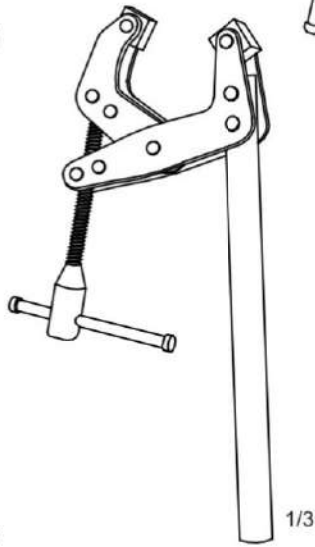

Fig.3

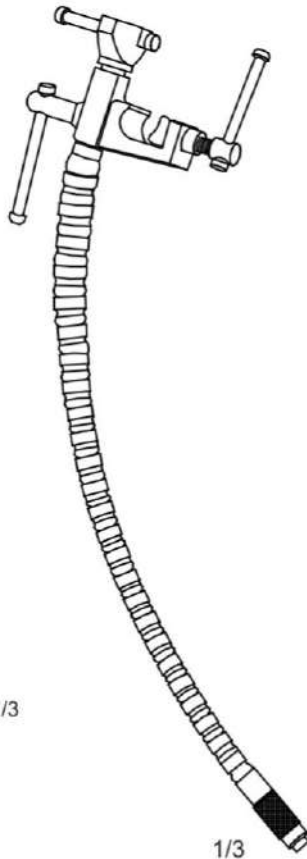

Fig.4



Fig.5



Fig.6

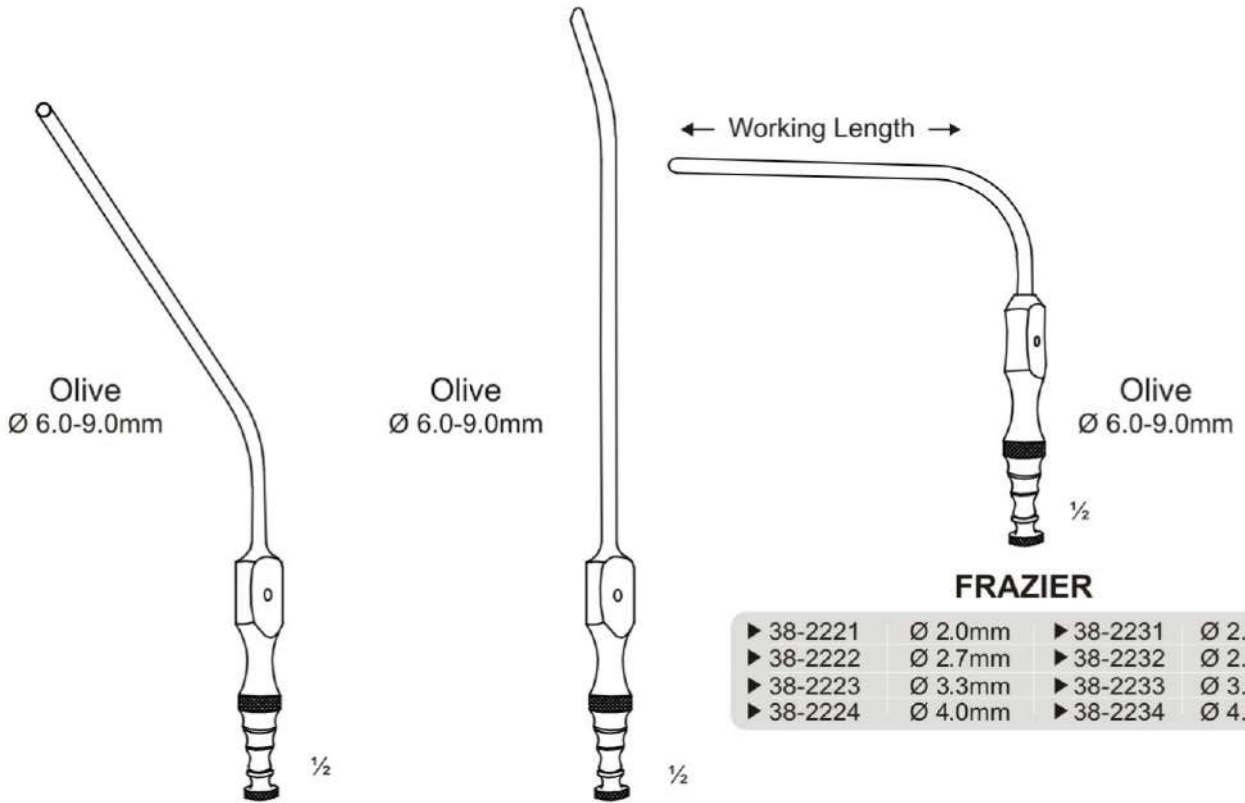

Fig.7



Fig.8

SET			
▶ 38-2190		Holding Rod for Fixation	Fig. 1
▶ 38-2191	42.0cm	Holding Rod for Fixation	Fig. 2
▶ 38-2192	21.3cm	Holding Rod for Fixation	Fig. 3
▶ 38-2193	21.3cm	Fixation on Operating Table	Fig. 3
▶ 38-2131	33.0cm	Flexible arm	Fig. 4
▶ 38-2185	15.0cm	Brain Spatula 14.0mm	Fig. 5
▶ 38-2186	15.0cm	Brain Spatula 8.0mm	Fig. 6
▶ 38-2187	15.0cm	Brain Spatula 11.0mm	Fig. 7
▶ 38-2188	15.0cm	Brain Spatula 3.0mm Teeth	Fig. 8



**FERGUSSON**

- ▶ 38-2201 Ø 2.0mm
- ▶ 38-2202 Ø 2.5mm
- ▶ 38-2203 Ø 3.0mm
- ▶ 38-2204 Ø 4.0mm
- ▶ 38-2205 Ø 5.0mm

**ADSON**

- ▶ 38-2210 Ø 4.0mm

**FRAZIER**

- |                   |                   |
|-------------------|-------------------|
| ▶ 38-2221 Ø 2.0mm | ▶ 38-2231 Ø 2.0mm |
| ▶ 38-2222 Ø 2.7mm | ▶ 38-2232 Ø 2.7mm |
| ▶ 38-2223 Ø 3.3mm | ▶ 38-2233 Ø 3.3mm |
| ▶ 38-2224 Ø 4.0mm | ▶ 38-2234 Ø 4.0mm |

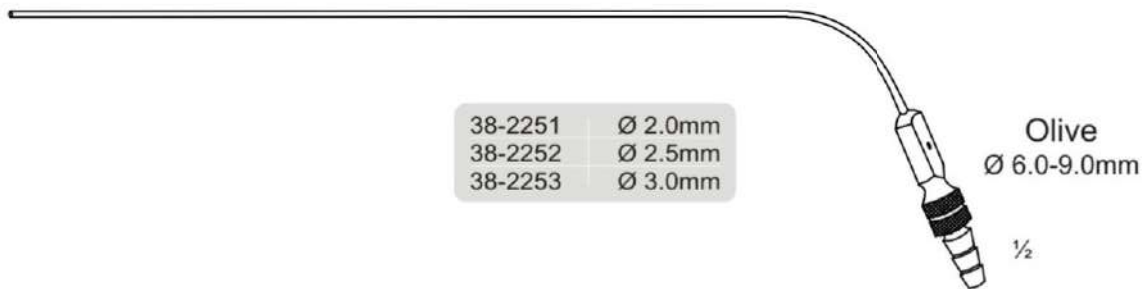

- 38-2251 Ø 2.0mm
- 38-2252 Ø 2.5mm
- 38-2253 Ø 3.0mm

Olive  
Ø 6.0-9.0mm

# Suction Tips



← Working Length →

38-2261	Ø 1.5mm
38-2262	Ø 2.0mm
38-2263	Ø 2.5mm
38-2264	Ø 3.5mm

38-2271	Ø 1.5mm
38-2272	Ø 2.0mm
38-2273	Ø 2.5mm
38-2274	Ø 3.5mm

38-2281	Ø 1.5mm
38-2282	Ø 2.0mm
38-2283	Ø 2.5mm
38-2284	Ø 3.5mm
38-2285	Ø 4.5mm

38-2291	Ø 1.5mm
38-2292	Ø 2.0mm
38-2293	Ø 2.5mm
38-2294	Ø 3.5mm

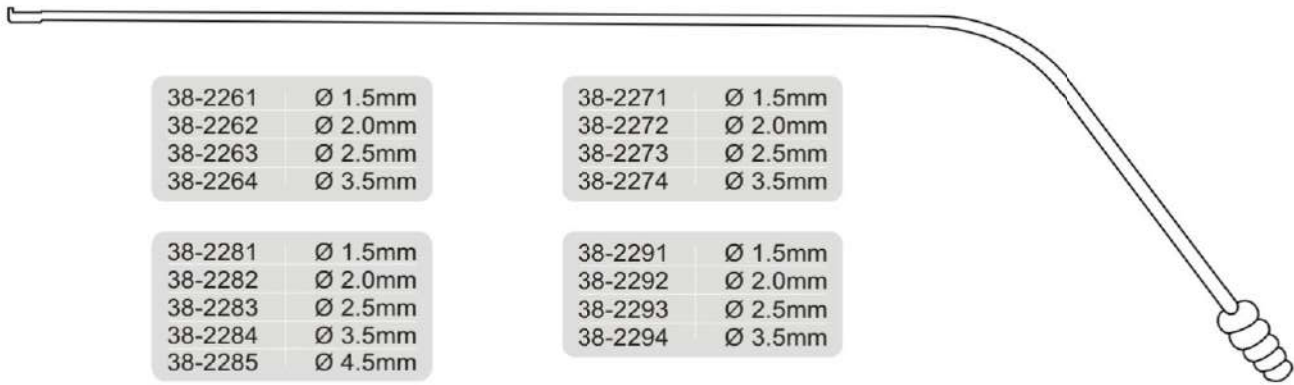

**YASARGIL**

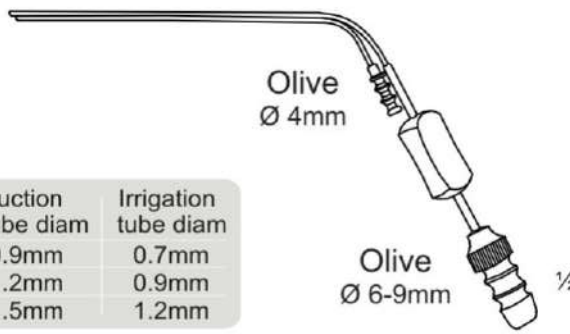

	Suction tube diam	Irrigation tube diam
38-2301	0.9mm	0.7mm
38-2302	1.2mm	0.9mm
38-2303	1.5mm	1.2mm

**HOUSE**  
Suction Irrigation

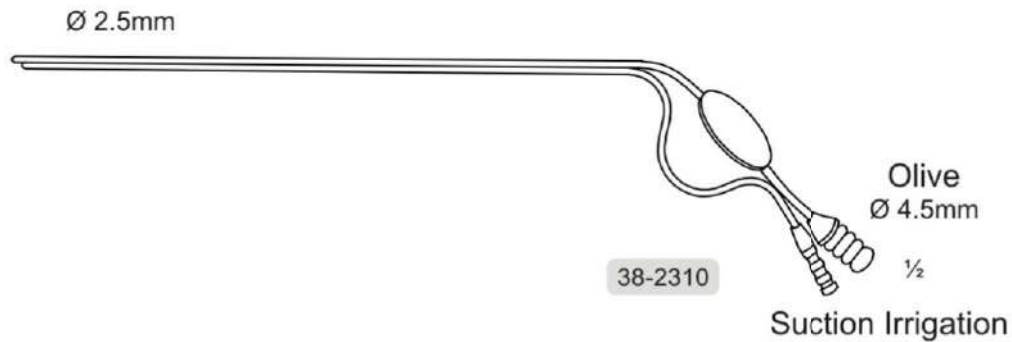

**38-2310**  
Suction Irrigation

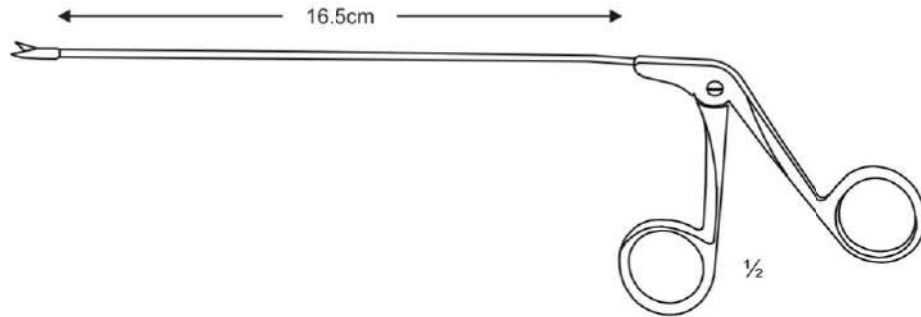

**NICOLA**

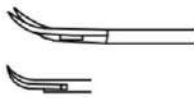

**FAHLBUSCH**

Micro Scissors, horizontal cutting

38-2401

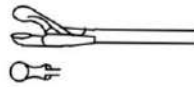

**NICOLA**

Forceps scoop-shaped

38-2410



**NICOLA**

Micro Scissors, straight

38-2402

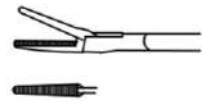

**YASARGIL-NICOLA**

Forceps

38-2420

**Laminectomy Punches**

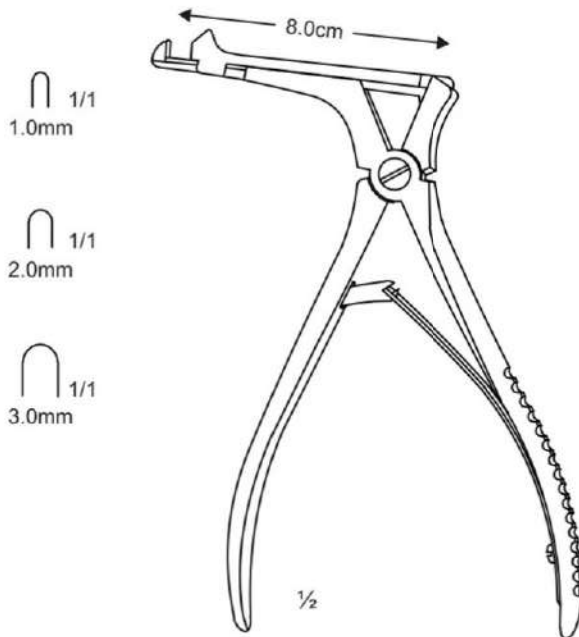

**CITELLY**

- 38-2501 1.0mm
- ▶ 38-2502 2.0mm
- 38-2503 3.0mm

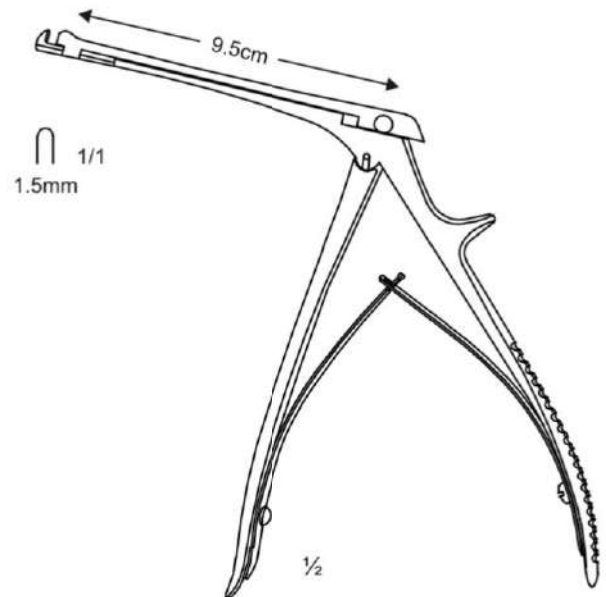

**BEYER**

38-2510





▶ 38-2601	3.0mm
▶ 38-2602	4.0mm
▶ 38-2603	5.0mm
▶ 38-2604	6.0mm

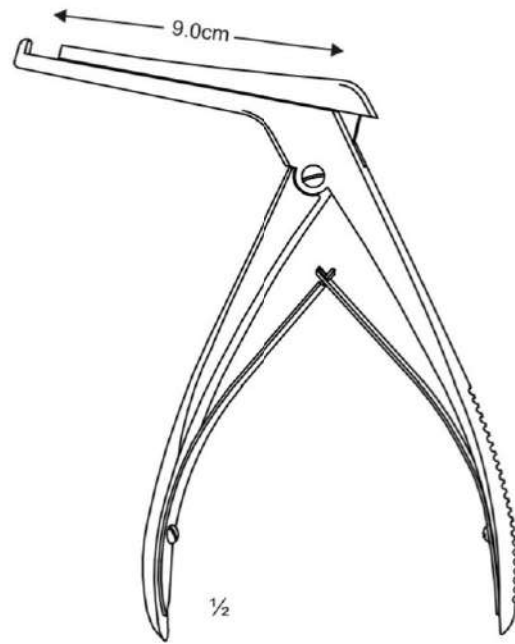

**KERRISON**  
Upwards cutting 90°

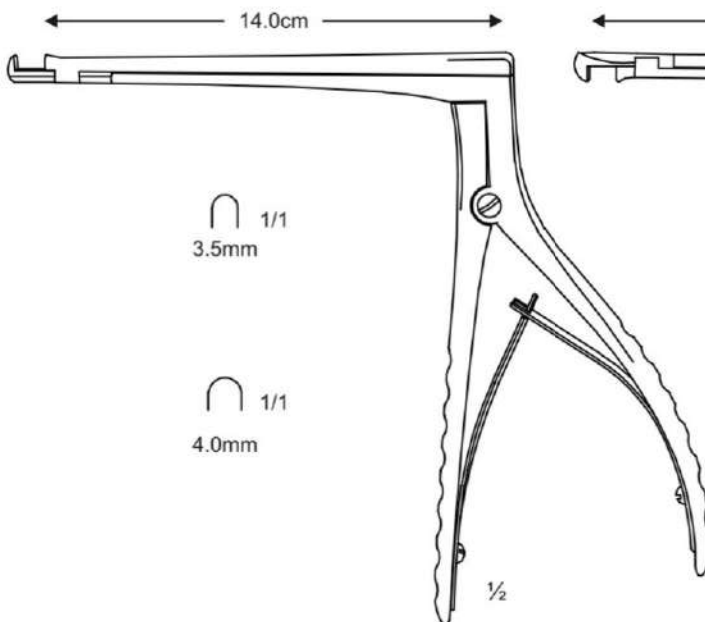

**HAJEK-KOFLER**  
Upwards cutting 90°

38-2701	3.5mm
38-2702	4.0mm

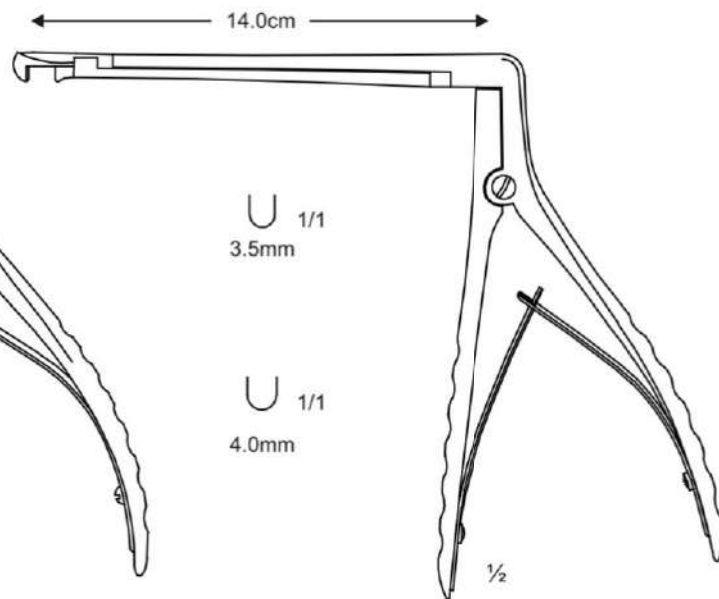

**HAJEK-KOFLER**  
Downwards cutting 90°

38-2711	3.5mm
38-2712	4.0mm



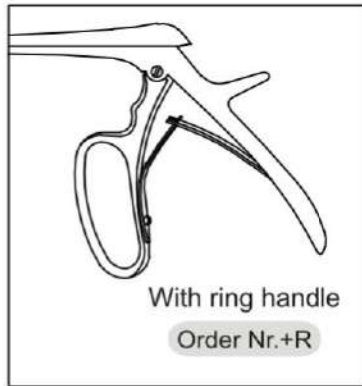
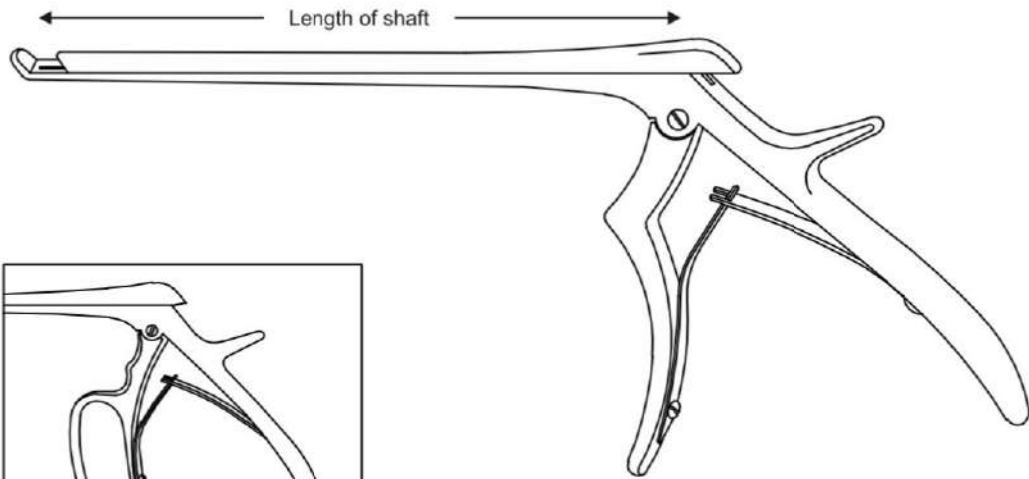

## FERRIS-SMITH-KERRISON

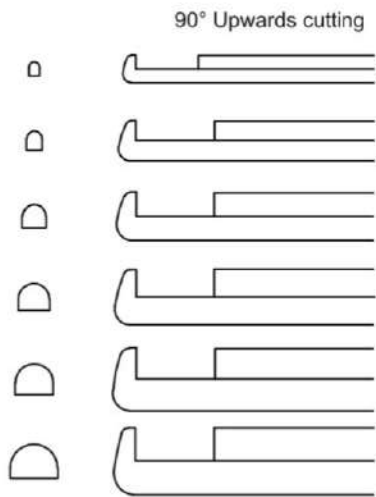

1/1

		Length of shaft		
		15.2cm	18.0cm	20.3cm
1mm		38-2801	38-2811	38-2821
2mm		38-2802	38-2812	▶ 38-2822
3mm		38-2803	38-2813	▶ 38-2823
4mm		38-2804	38-2814	▶ 38-2824
5mm		38-2805	38-2815	▶ 38-2825
6mm		38-2806	38-2816	▶ 38-2826

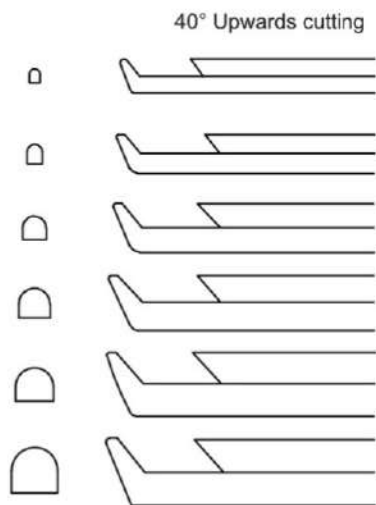

1/1

		Length of shaft		
		15.2cm	18.0cm	20.3cm
1mm		38-2901	38-2911	38-2921
2mm		38-2902	38-2912	▶ 38-2922
3mm		38-2903	38-2913	▶ 38-2923
4mm		38-2904	38-2914	▶ 38-2924
5mm		38-2905	38-2915	▶ 38-2925
6mm		38-2906	38-2916	▶ 38-2926

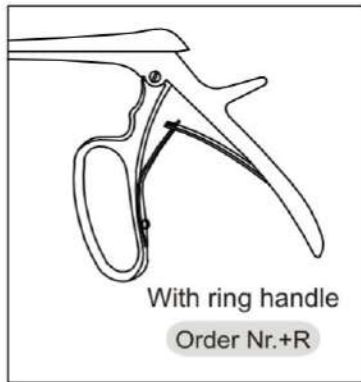
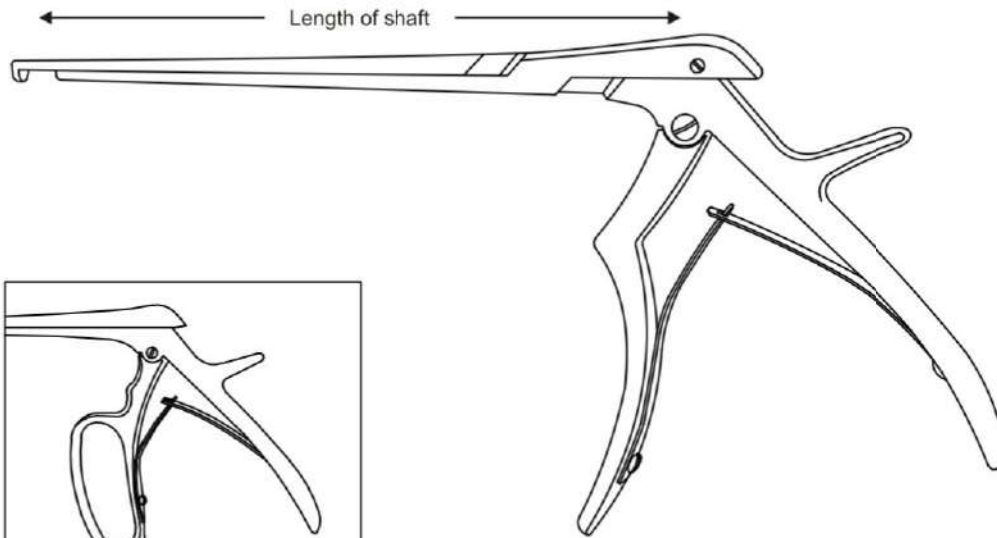

**FERRIS-SMITH-KERRISON**

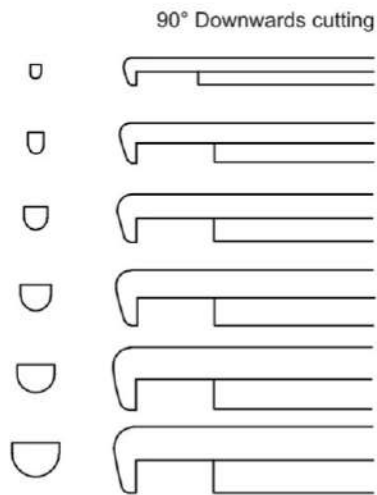

	Length of shaft	
	18.0cm	20.3cm
1mm	38-3011	38-3021
2mm	38-3012	38-3022
3mm	38-3013	▶ 38-3023
4mm	38-3014	▶ 38-3024
5mm	38-3015	▶ 38-3025
6mm	38-3016	▶ 38-3026

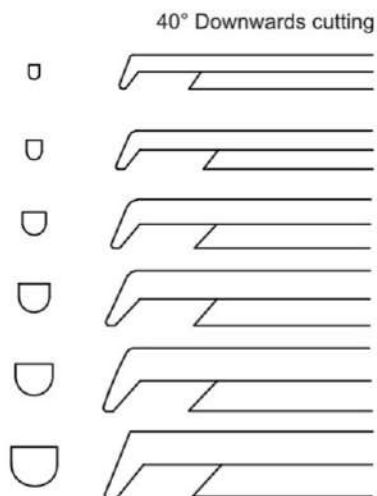

	Length of shaft	
	18.0cm	20.3cm
1mm	38-3111	38-3121
2mm	38-3112	38-3122
3mm	38-3113	38-3123
4mm	38-3114	38-3124
5mm	38-3115	38-3125
6mm	38-3116	38-3126

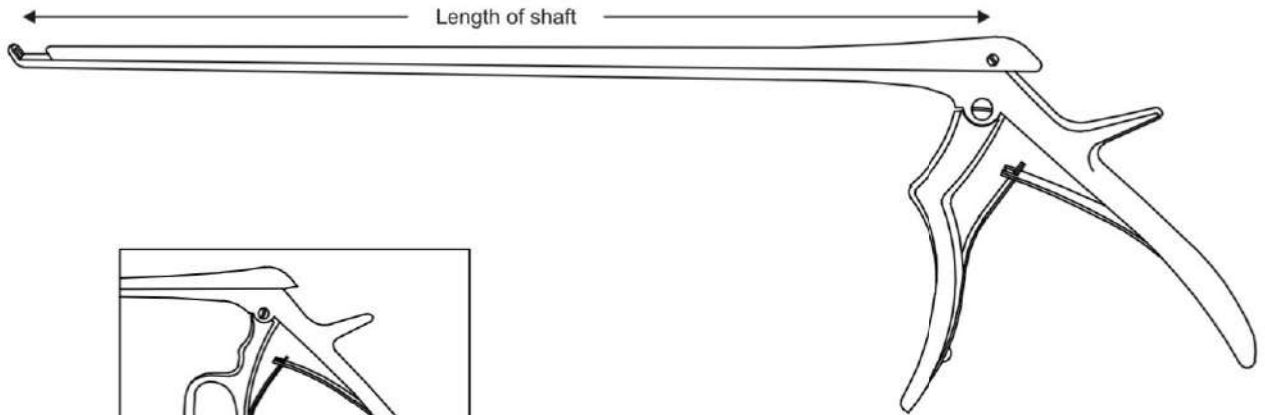

**FERRIS-SMITH-KERRISON**

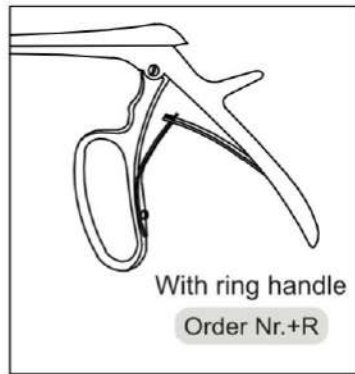

90° Upwards cutting

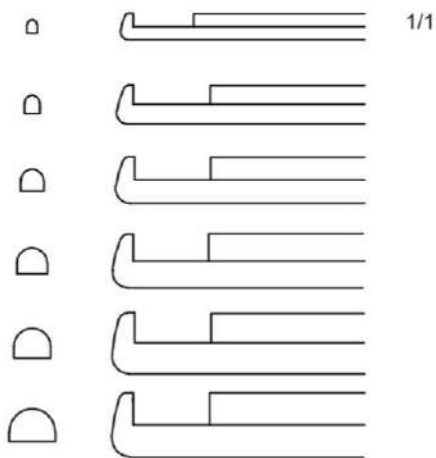

	Length of shaft		
	27.9cm	30.5cm	33.0cm
1mm	38-3201	38-3211	38-3221
2mm	38-3202	38-3212	38-3222
3mm	38-3203	38-3213	38-3223
4mm	38-3204	38-3214	38-3224
5mm	38-3205	38-3215	38-3225
6mm	38-3206	38-3216	38-3226

40° Upwards cutting

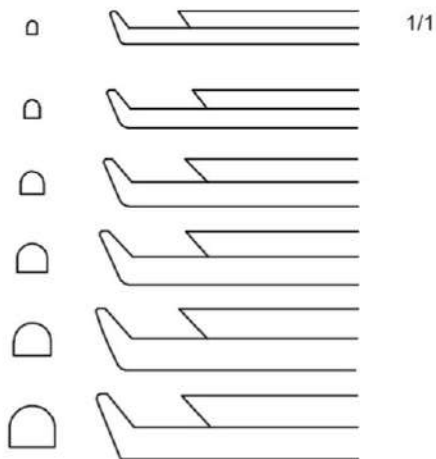

	Length of shaft		
	37.9cm	30.5cm	33.0cm
1mm	38-3301	38-3311	38-3321
2mm	38-3302	38-3312	38-3322
3mm	38-3303	38-3313	38-3323
4mm	38-3304	38-3314	38-3324
5mm	38-3305	38-3315	38-3325
6mm	38-3306	38-3316	38-3326

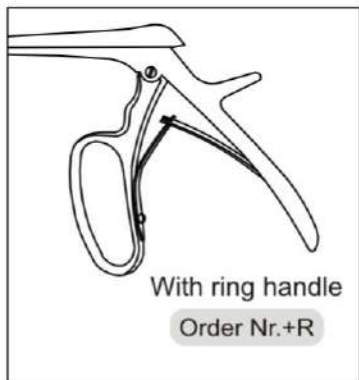
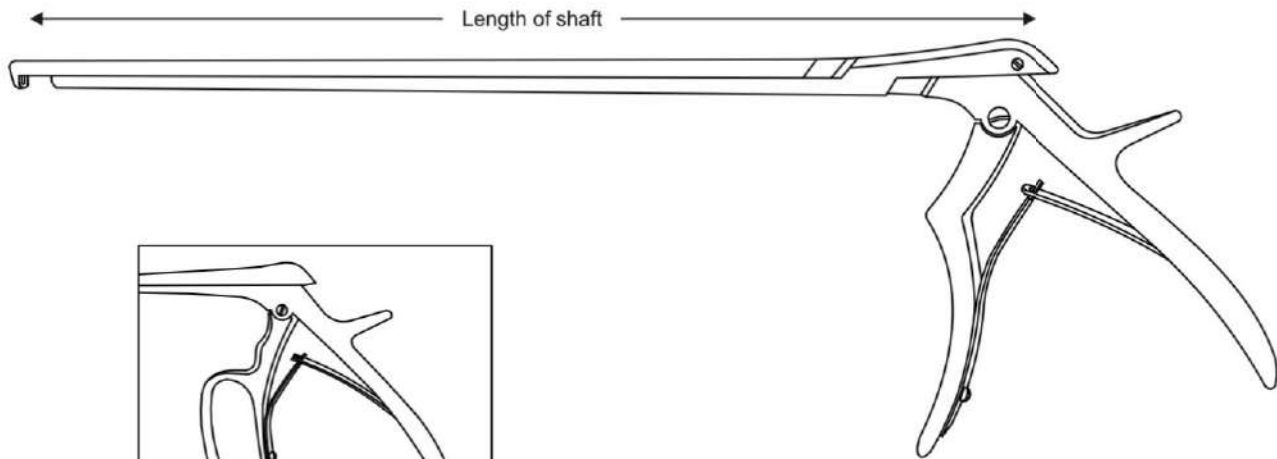

**FERRIS-SMITH-KERRISON**

90° Downwards cutting

□		1/1
□		
D		
D		
D		
D		

	Length of shaft		
	27.9cm	30.5cm	33.0cm
1mm	38-3401	38-3411	38-3421
2mm	38-3402	38-3412	38-3422
3mm	38-3403	38-3413	38-3423
4mm	38-3404	38-3414	38-3424
5mm	38-3405	38-3415	38-3425
6mm	38-3406	38-3416	38-3426

40° Downwards cutting

□		1/1
□		
D		
D		
D		
D		

	Length of shaft		
	27.9cm	30.5cm	33.0cm
1mm	38-3501	38-3511	38-3521
2mm	38-3502	38-3512	38-3522
3mm	38-3503	38-3513	38-3523
4mm	38-3504	38-3514	38-3524
5mm	38-3505	38-3515	38-3525
6mm	38-3506	38-3516	38-3526

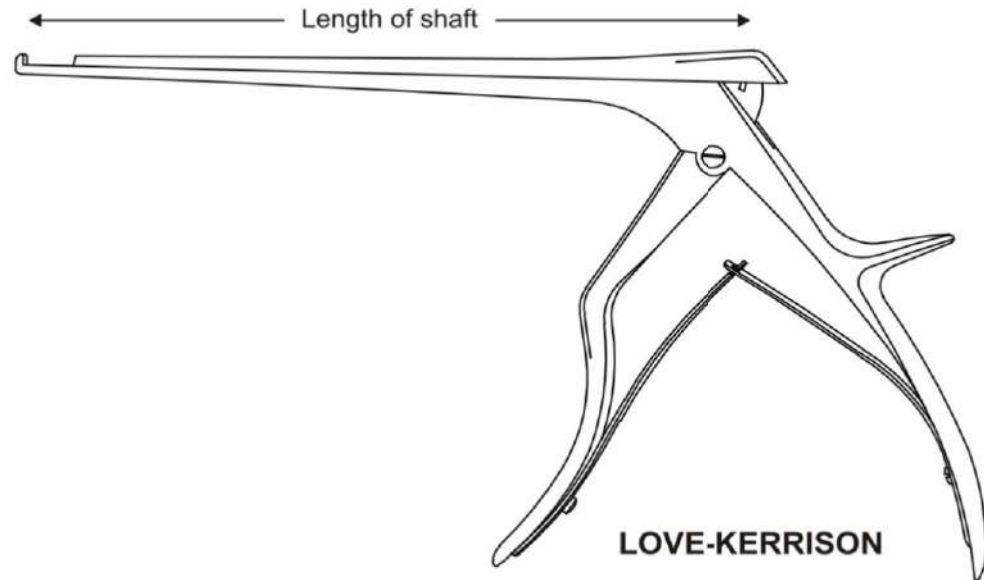

## LOVE-KERRISON

Length of shaft

90° Upwards cutting

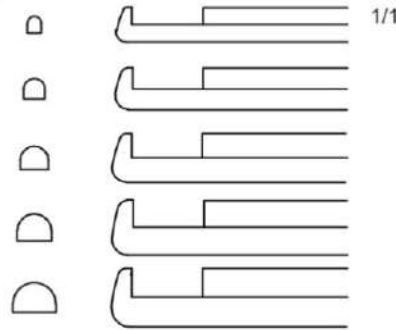

1/1

	15.0cm	18.0cm	20.0cm
2mm	38-3602	38-3612	38-3622
3mm	38-3603	38-3613	38-3623
4mm	38-3604	38-3614	38-3624
5mm	38-3605	38-3615	38-3625
6mm	38-3606	38-3616	38-3626

45° Downwards cutting

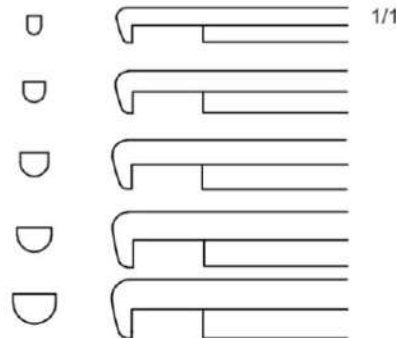

1/1

2mm	38-3702	38-3712	38-3722
3mm	38-3703	38-3713	38-3723
4mm	38-3704	38-3714	38-3724
5mm	38-3705	38-3715	38-3725
6mm	38-3706	38-3716	38-3726

40° Upwards cutting

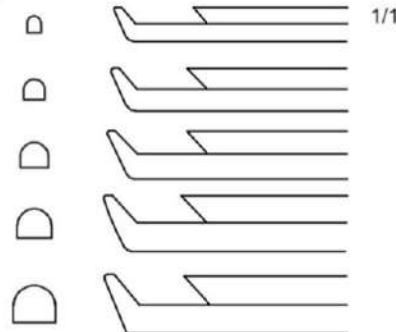

1/1

2mm	38-3802	38-3812	38-3822
3mm	38-3803	38-3813	38-3823
4mm	38-3804	38-3814	38-3824
5mm	38-3805	38-3815	38-3825
6mm	38-3806	38-3816	38-3826



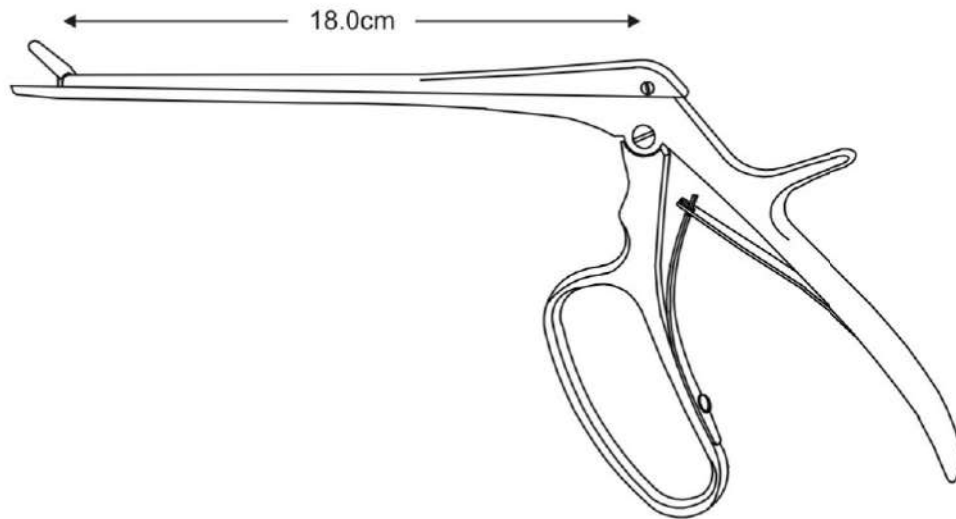

**FERRIS-SMITH-CUSHING**

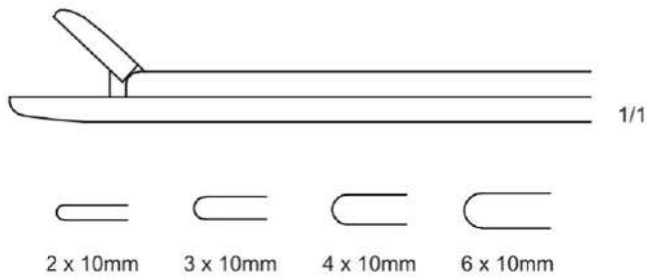

2 x 10mm	3 x 10mm	4 x 10mm	6 x 10mm
38-3902	38-3903	38-3904	38-3906

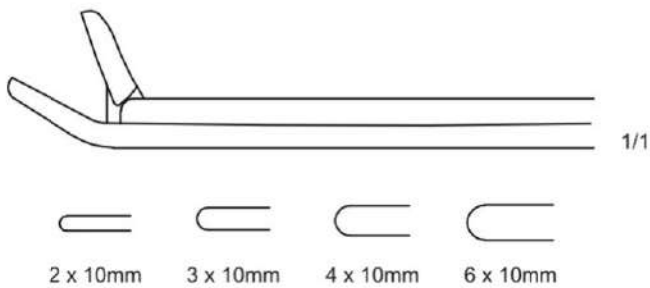

2 x 10mm	3 x 10mm	4 x 10mm	6 x 10mm
38-3912	38-3913	38-3914	38-3916

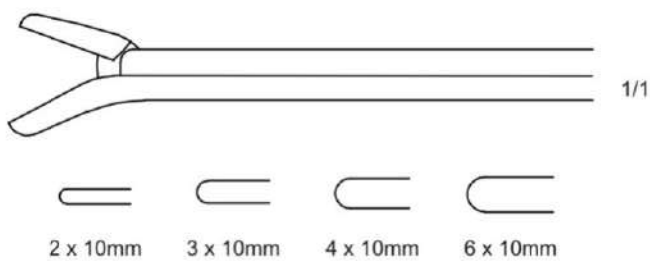

2 x 10mm	3 x 10mm	4 x 10mm	6 x 10mm
38-3922	38-3923	38-3924	38-3926

38-4001 3.0mm

38-4002 3.6mm

38-4003 4.2mm

38-4004 4.8mm

38-4005 5.8mm

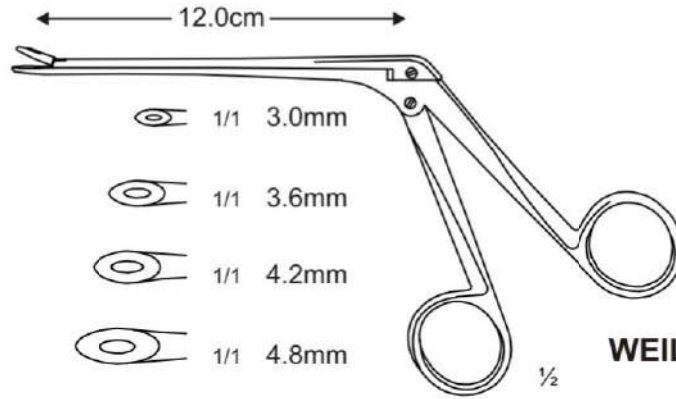

**WEIL-BLAKESLEY**  
Straight

38-4012 3.6mm

38-4013 4.2mm

38-4014 4.8mm

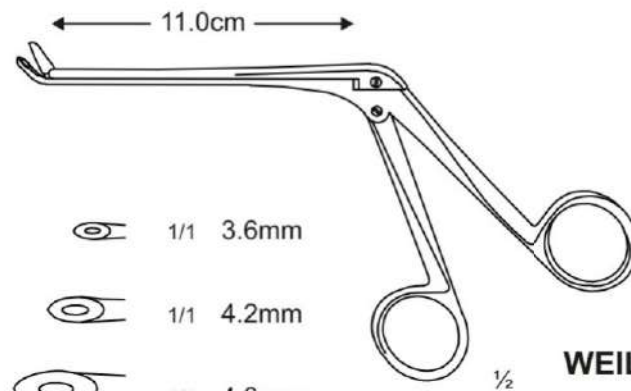

**WEIL-BLAKESLEY**  
Curved up

38-4101 3.0mm

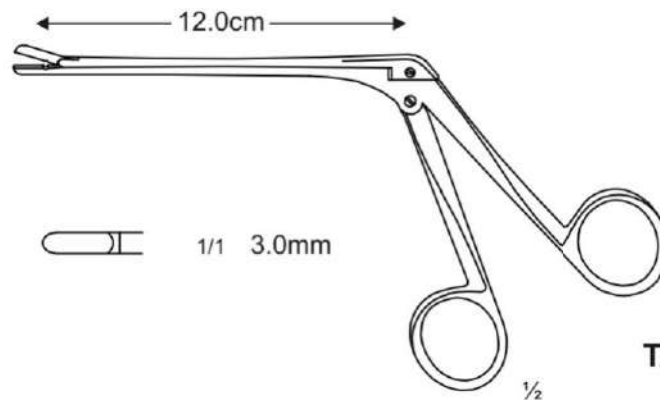

**TAKAHASHI**  
Straight

38-4111 3.0mm

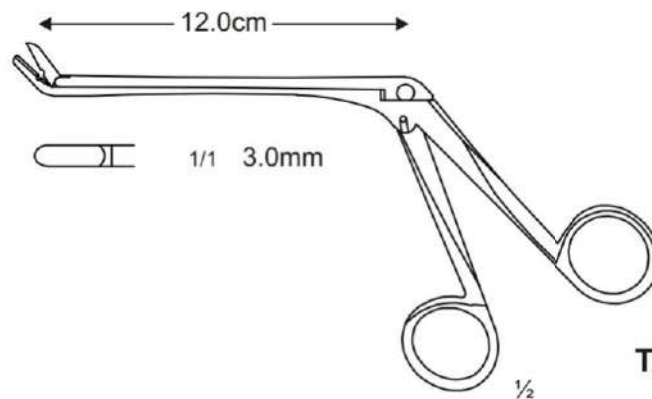

**TAKAHASHI**  
Curved up



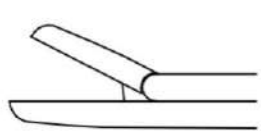
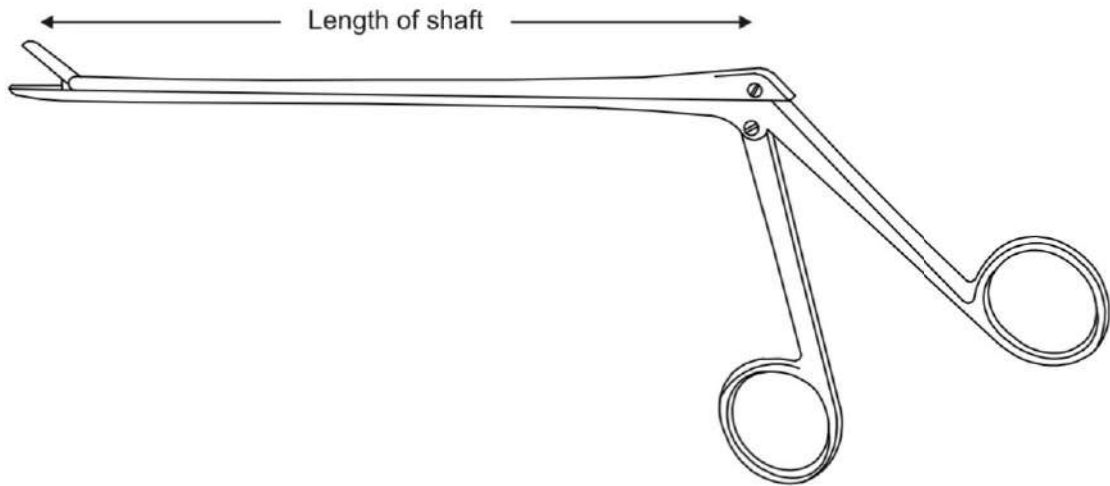

1/1

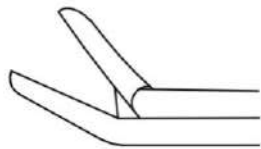

1/1

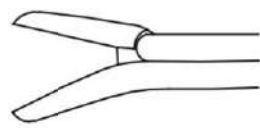

1/1

Length of shaft  
12.0cm  
15.0cm  
18.0cm

**Cushing**  
2 x 10mm

- ▶ 38-4201
- ▶ 38-4202
- ▶ 38-4203

**Cushing**  
2 x 10mm

- ▶ 38-4211
- ▶ 38-4212
- ▶ 38-4213

**Cushing**  
2 x 10mm

- ▶ 38-4221
- ▶ 38-4222
- ▶ 38-4223

Length of shaft  
12.0cm  
15.0cm  
18.0cm

**Love-Gruenwald**  
3 x 10mm

- ▶ 38-4301
- ▶ 38-4302
- ▶ 38-4303

**Love-Gruenwald**  
3 x 10mm

- ▶ 38-4311
- ▶ 38-4312
- ▶ 38-4313

**Love-Gruenwald**  
3 x 10mm

- ▶ 38-4321
- ▶ 38-4322
- ▶ 38-4323

Length of shaft  
12.0cm  
15.0cm  
18.0cm

**Spurling**  
4 x 10mm

- ▶ 38-4401
- ▶ 38-4402
- ▶ 38-4403

**Spurling**  
4 x 10mm

- ▶ 38-4411
- ▶ 38-4412
- ▶ 38-4413

**Spurling**  
4 x 10mm

- ▶ 38-4421
- ▶ 38-4422
- ▶ 38-4423

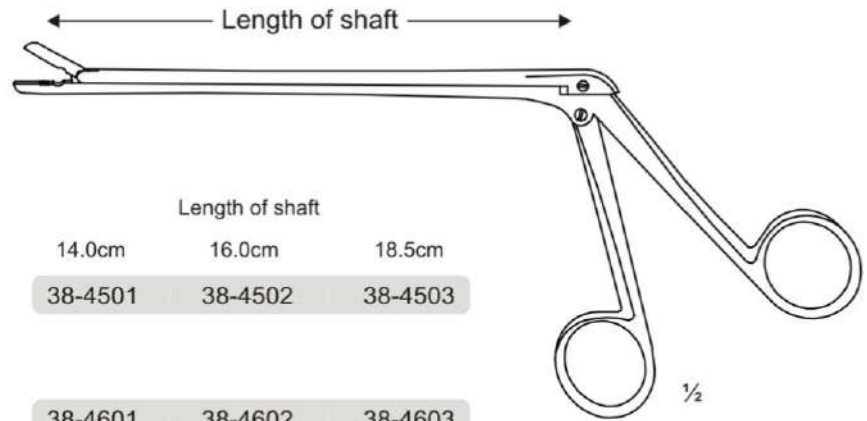

			Length of shaft		
			14.0cm	16.0cm	18.5cm
	1/1	2 x 12mm	38-4501	38-4502	38-4503
	1/1	3 x 12mm	38-4601	38-4602	38-4603
	1/1	4 x 14mm	38-4701	38-4702	38-4703
	1/1	5 x 14mm	38-4801	38-4802	38-4803
	1/1	6 x 16mm	38-4901	38-4902	38-4903

**CASPAR**

Serrated and fenestrated jaws

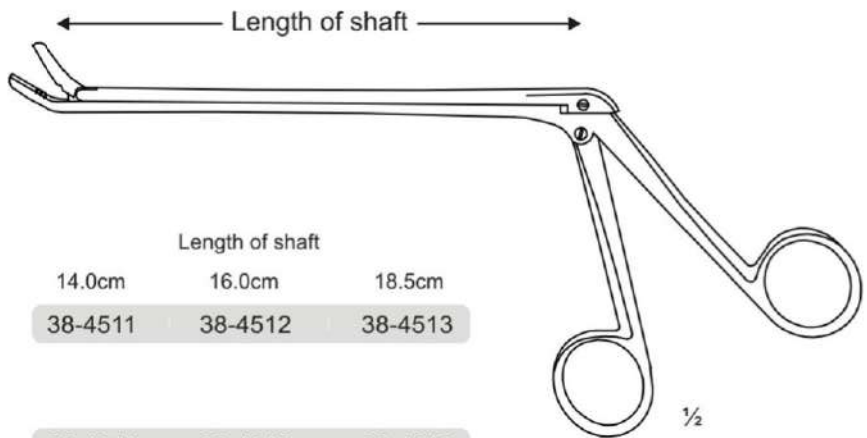

			Length of shaft		
			14.0cm	16.0cm	18.5cm
	1/1	2 x 12mm	38-4511	38-4512	38-4513
	1/1	3 x 12mm	38-4611	38-4612	38-4613
	1/1	4 x 14mm	38-4711	38-4712	38-4713
	1/1	5 x 14mm	38-4811	38-4812	38-4813
	1/1	6 x 16mm	38-4911	38-4912	38-4913

**CASPAR**

Serrated and fenestrated jaws

# Laminectomy Rongeurs

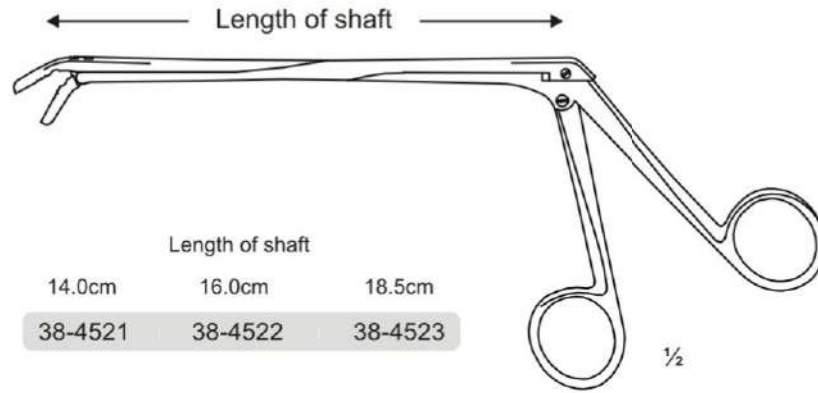

		Length of shaft		
		14.0cm	16.0cm	18.5cm
	1/1 2 x 12mm	38-4521	38-4522	38-4523
	1/1 3 x 12mm	38-4621	38-4622	38-4623
	1/1 4 x 14mm	38-4721	38-4722	38-4723
	1/1 5 x 14mm	38-4821	38-4822	38-4823
	1/1 6 x 16mm	38-4921	38-4922	38-4923

**CASPAR**  
Serrated and fenestrated jaws

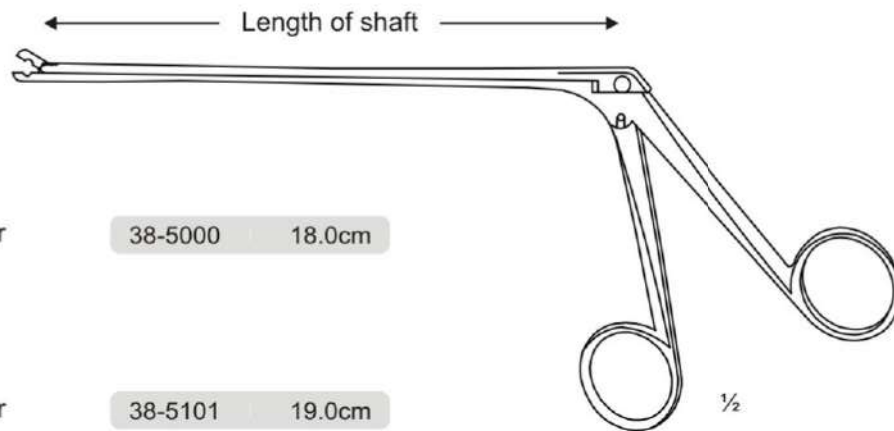

**OLDBERG**

**OLDBERG**  
Sharp Pituitary Rongeur  
Ø 7.0mm

38-5000 18.0cm

**LANDOLT**  
Sharp Pituitary Rongeur  
Ø 2.2mm

38-5101 19.0cm

**YASARGIL**  
Sharp Pituitary Rongeur  
Ø 3.5mm

38-5100 19.0cm

**LANDOLT**  
Tumor Grasping Forceps, blunt  
Ø 9.0mm

38-5102 20.0cm



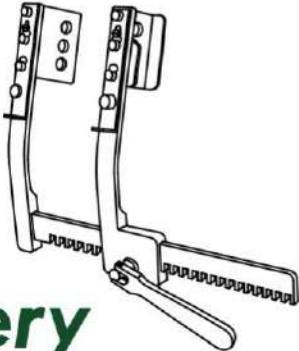

# Chest Surgery

## Chest Surgery



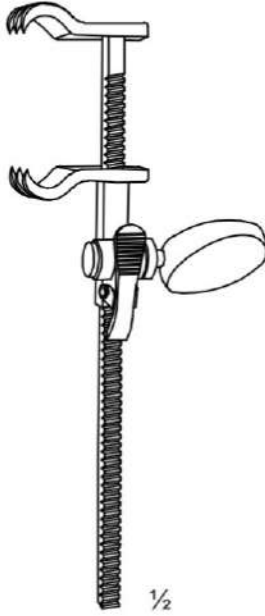

**BAILEY-BABY**  
Rib contractor

▶ 39-0101 14.0 cm

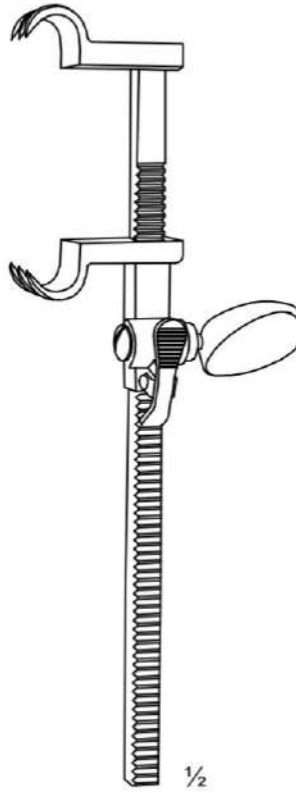

**BAILEY**  
Rib contractor for children

39-0102 16.0 cm

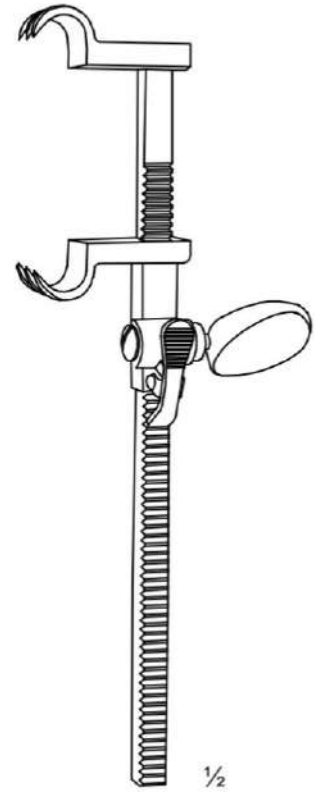

**BAILEY-GIBBON**  
Rib contractor for Adult

▶ 39-0103 16.0 cm

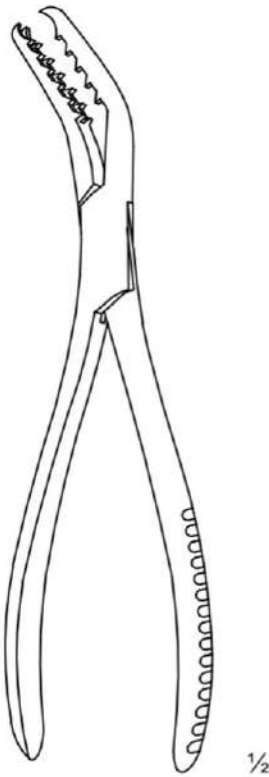

**SEMB**  
Rib holding forceps  
without Ratchet

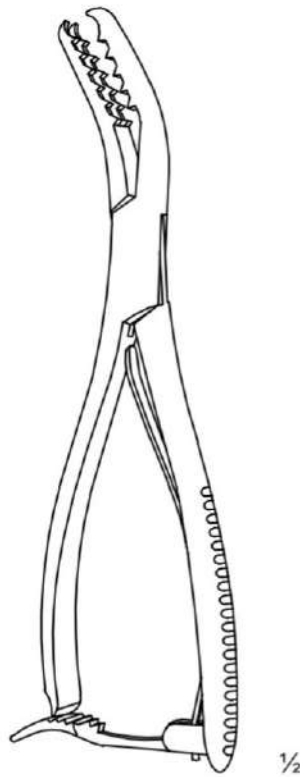

**SEMB**  
Rib holding forceps  
without Ratchet

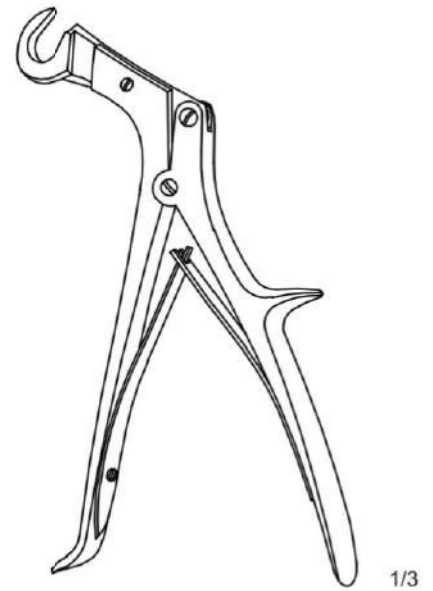

**GIERTZ-STILLE**  
Rib shears



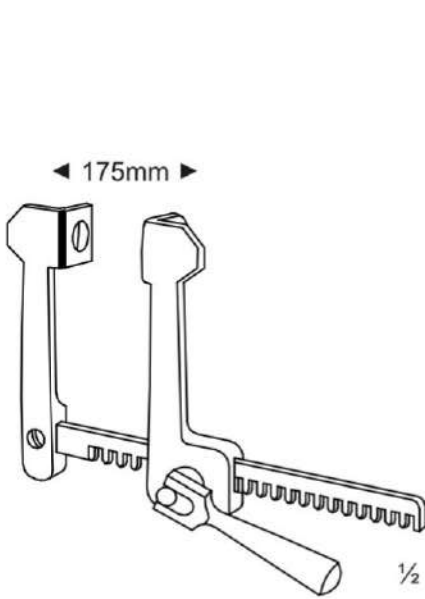

**FINOCHIETTO-BABY**

▶ 39-0401 18 x 20mm

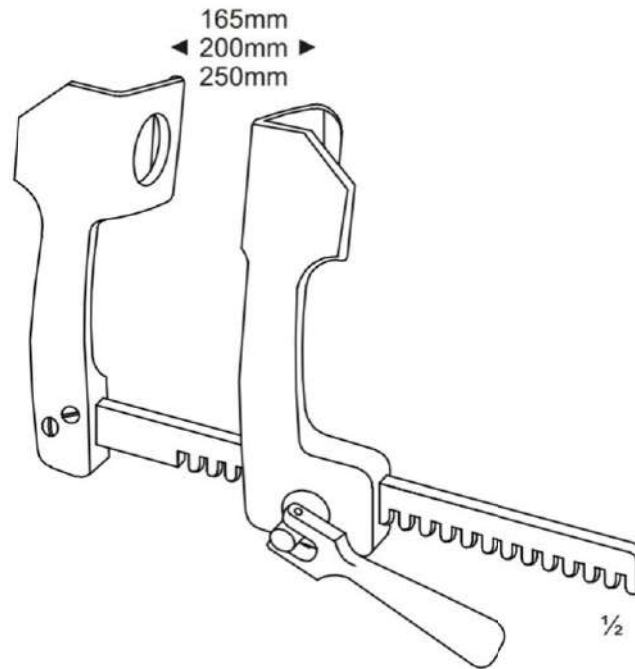

**FINOCHIETTO**

▶ 39-0402 40 x 45mm  
 ▶ 39-0403 45 x 65mm  
 39-0404 70 x 65mm

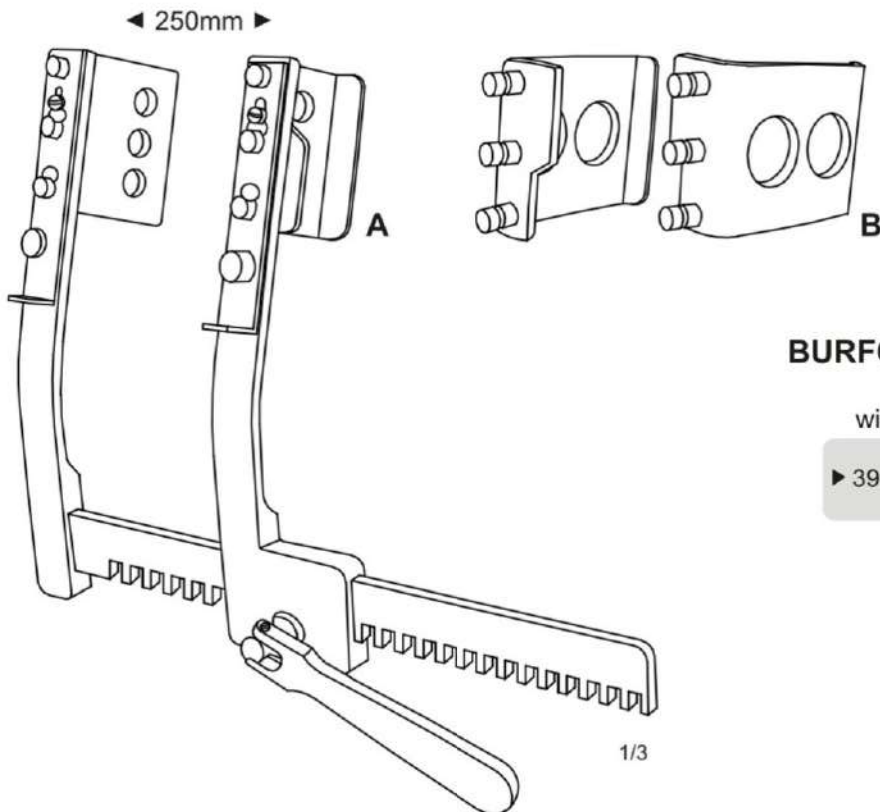

**BURFORD-FINOCHIETTO**

For adult  
 with 2 pairs of blades

▶ 39-0500 **A** 45 x 65mm  
**B** 70 x 65mm



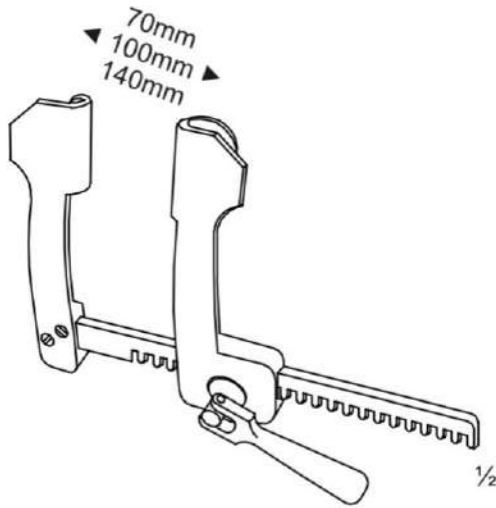

**COOLEY**

- ▶ 39-0601 13 x 16mm For Babies
- ▶ 39-0602 13 x 20mm For Children
- ▶ 39-0603 20 x 30mm For Adults

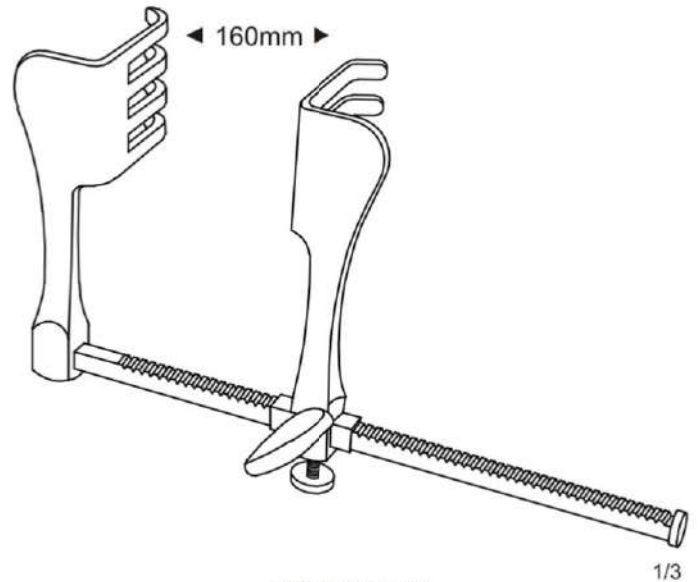

**BADGLEY**

- ▶ 39-0700 52 x 44mm

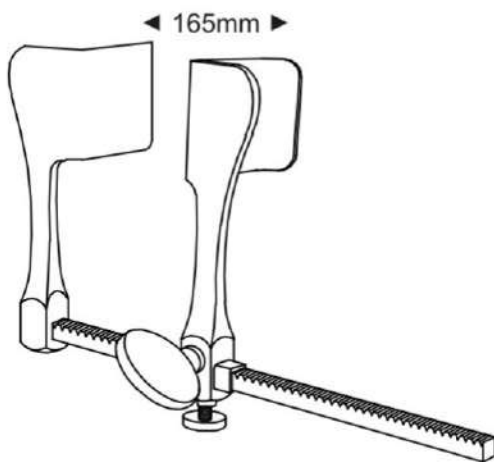

**TUFFIER**

- ▶ 39-0800 50 x 45mm

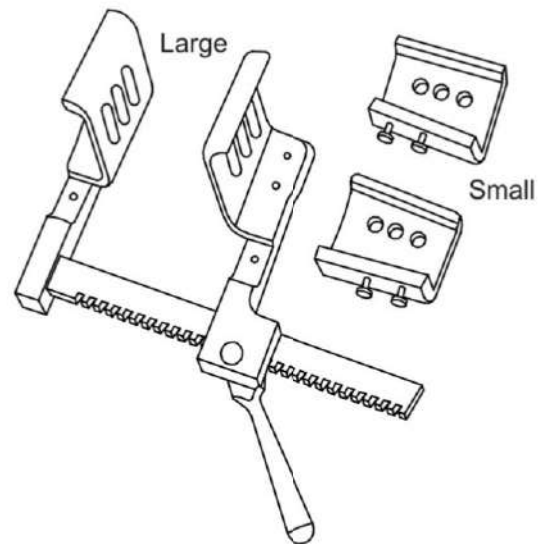

**HARKEN**

- ▶ 39-0900 Set
- ▶ 39-0901 Body only
- ▶ 39-0910 Blade Large
- ▶ 39-0920 Blade Small

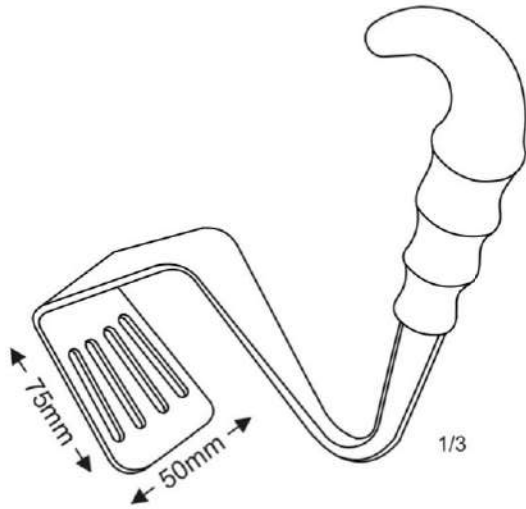

**DAVIDSON**  
Scapula Retractor

39-1001 16.0cm

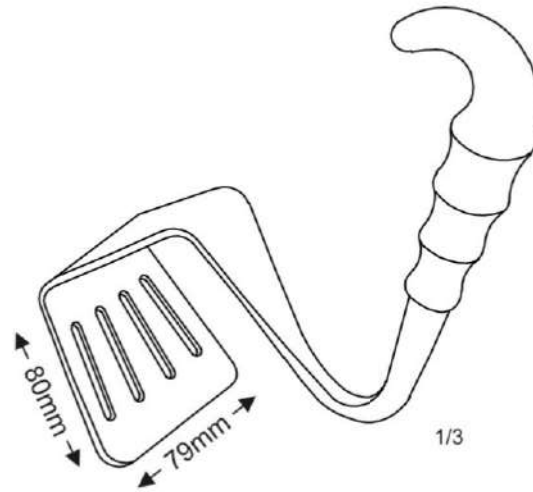

**DAVIDSON**  
Scapula Retractor

39-1002 16.0cm

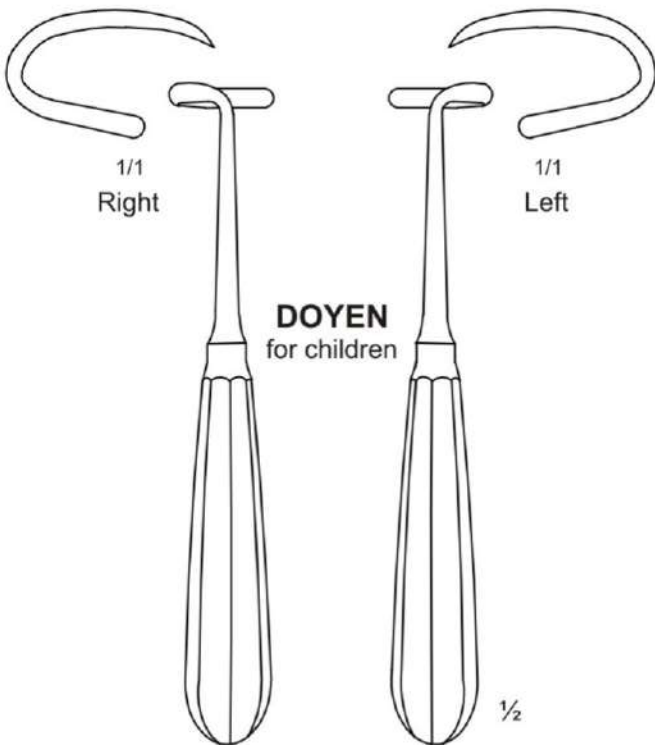

**DOYEN**  
for children

▶ 39-1101 17.0cm  
▶ 39-1102 17.0cm

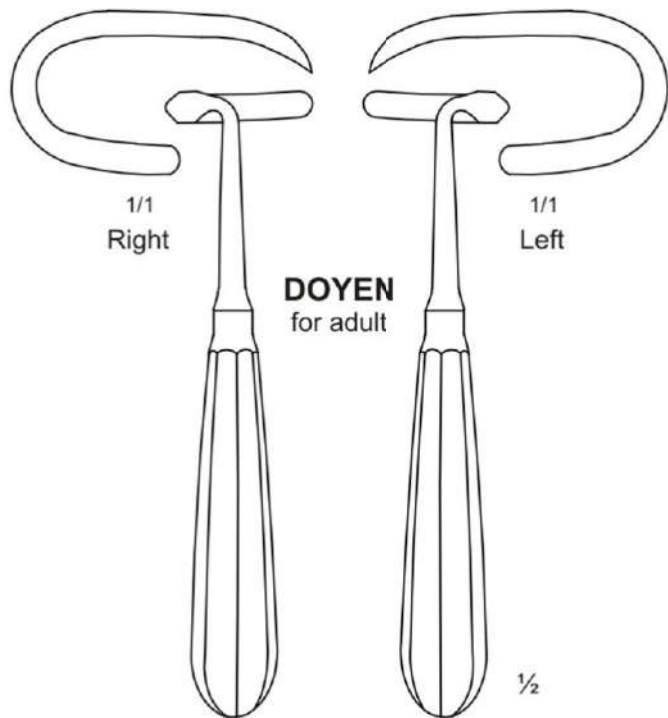

**DOYEN**  
for adult

39-1103 17.0cm  
39-1104 17.0cm

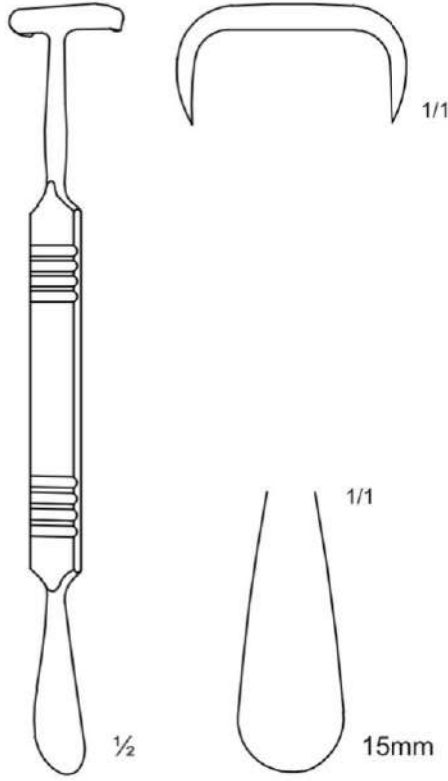

**MATSON**

▶ 39-1200 22.0cm

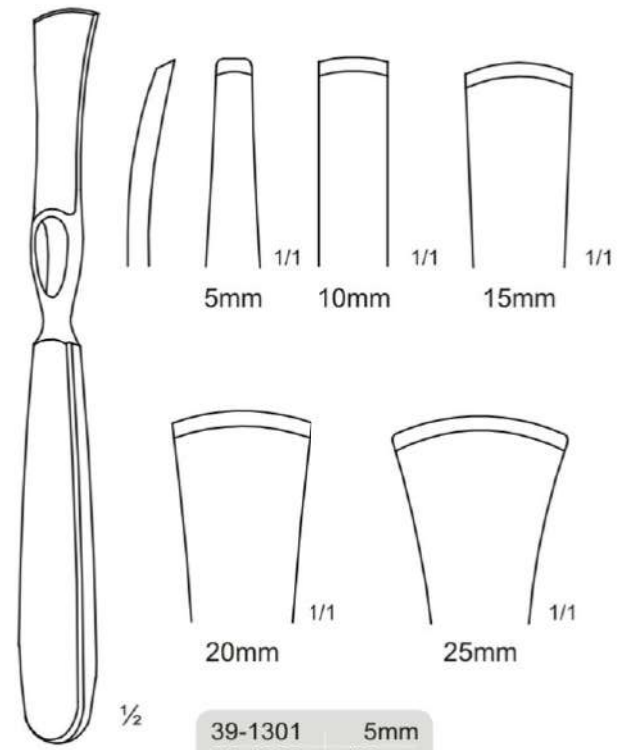

**LAMBOTTE**

39-1301	5mm
39-1302	10mm
39-1303	15mm
39-1304	20mm
39-1305	25mm

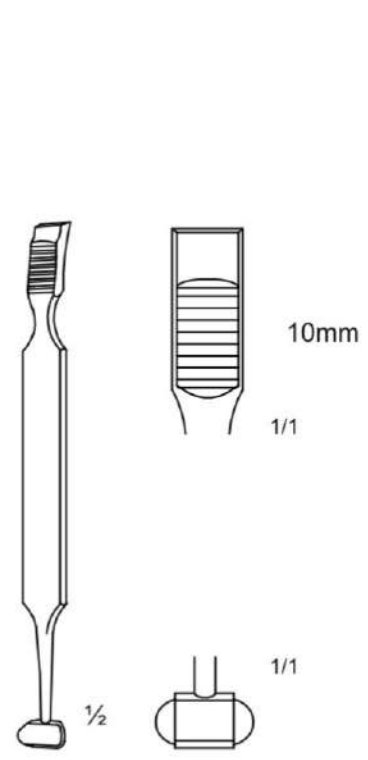

**ALEXANDER-FARABEUF**

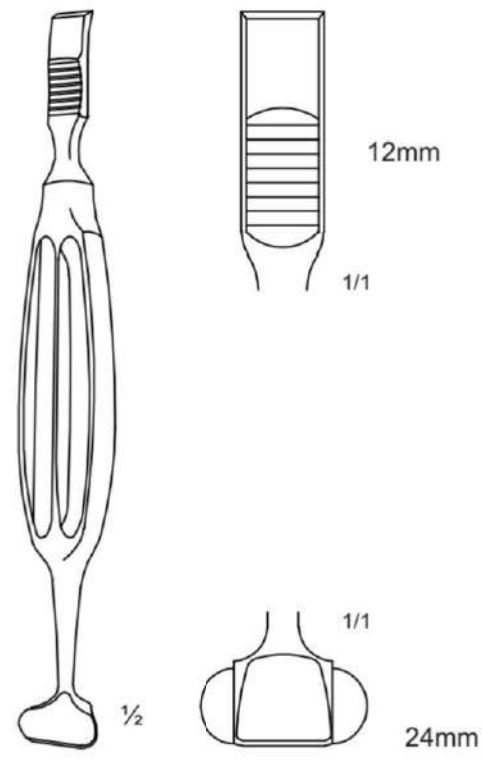

**ALEXANDER-FARABEUF**

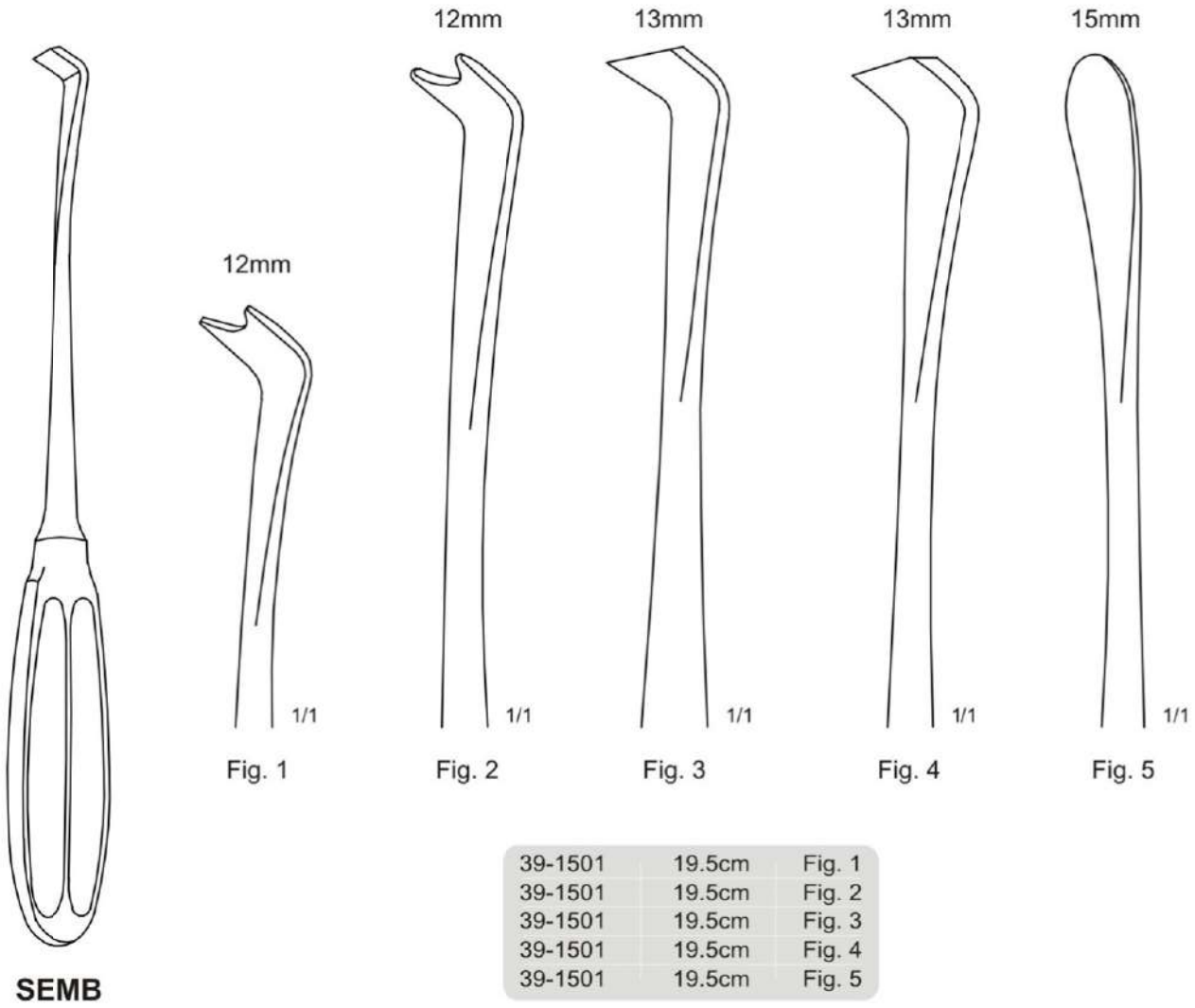





# Ophthalmology Surgery

Ophthalmology Surgery

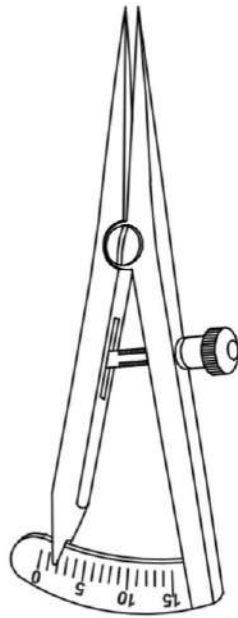

**CASTROVIEJO**

40-0101	15mm	Straight
40-0102	15mm	Straight with teflon
40-0111	15mm	Curved
40-0112	15mm	Curved with teflon

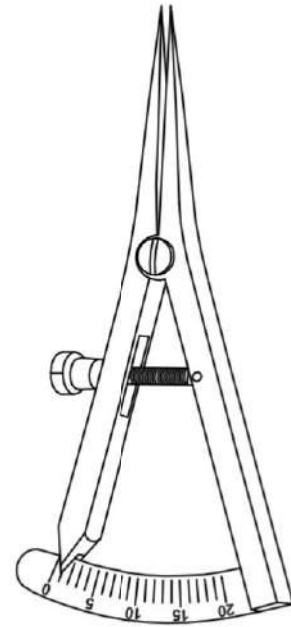

**CASTROVIEJO**

▶ 40-0201	20mm	Straight
40-0202	20mm	Straight with teflon
40-0211	20mm	Curved
40-0212	20mm	Curved with teflon
40-0203	20mm	Straight Scale division 0.5
40-0213	20mm	Curved Scale division 0.5



**LW  
GAUGE**

▶ 40-0300	16.5cm
-----------	--------



**Stainless Rulers**

▶ 40-0401	15.0cm
▶ 40-0402	30.0cm
▶ 40-0403	50.0cm



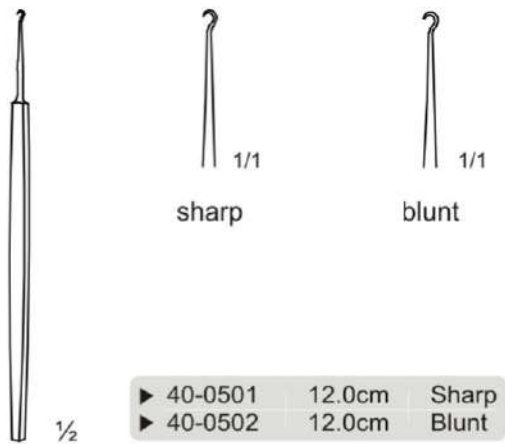

▶ 40-0501	12.0cm	Sharp
▶ 40-0502	12.0cm	Blunt

**GRAEFE (TYRELL)**

Iris hooks

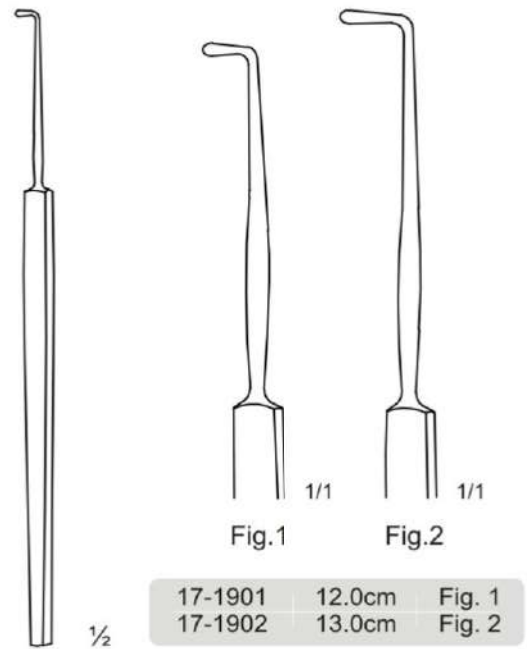

17-1901	12.0cm	Fig. 1
17-1902	13.0cm	Fig. 2

**GRAEFE**

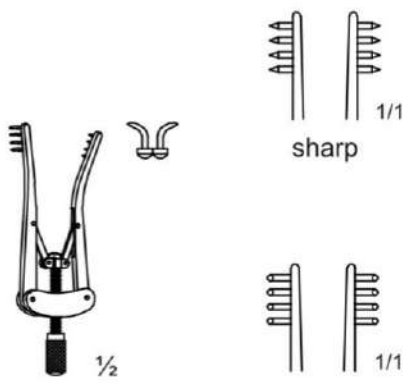

**ALM**  
4 x 4 prongs

16-0101	7.0cm	Sharp
16-0201	7.0cm	Blunt

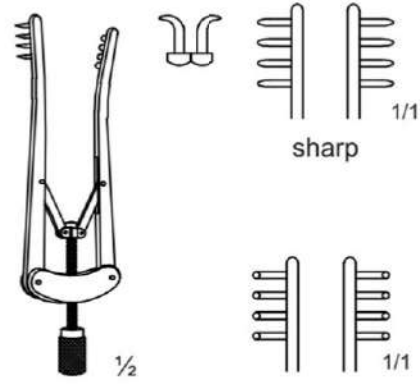

**ALM**  
4 x 4 prongs

16-0102	10.0cm	Sharp
16-0202	10.0cm	Blunt

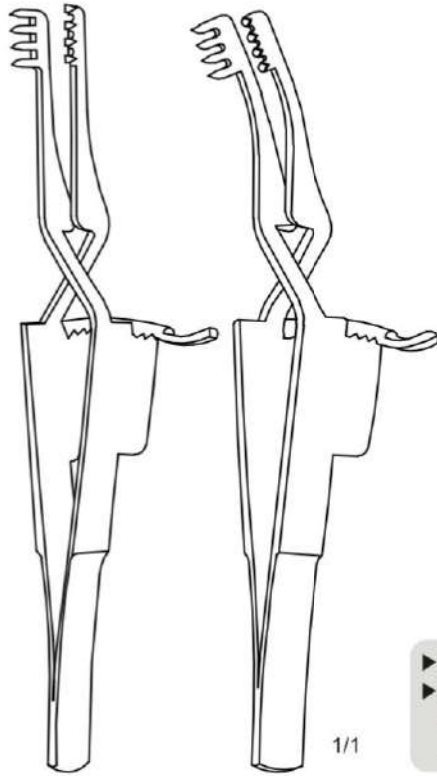

**HOLTZHEIMER**  
4-teeth

▶ 40-0601	10cm	Sharp	Straight
▶ 40-0602	10cm	Blunt	Straight
40-0611	10cm	Sharp	Curved
40-0612	10cm	Blunt	Curved

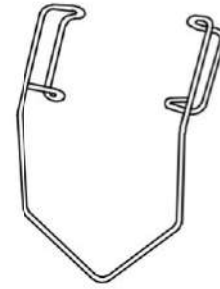

**BARRAQUER**

40-0701	Fenestrated
40-0702	Fenestrated, for infants

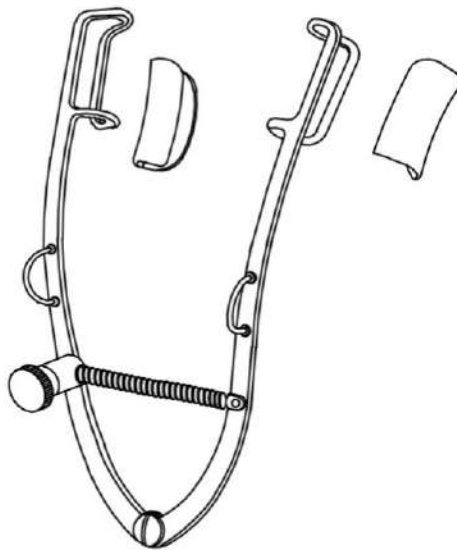

**WEISS**

40-0801	Fenestrated, for adults
40-0802	Fenestrated, for infants
40-0803	Solid, for adults
40-0804	Solid, for infants



**CASTROVIEJO**

40-0901	Small
40-0902	Medium
40-0903	Large

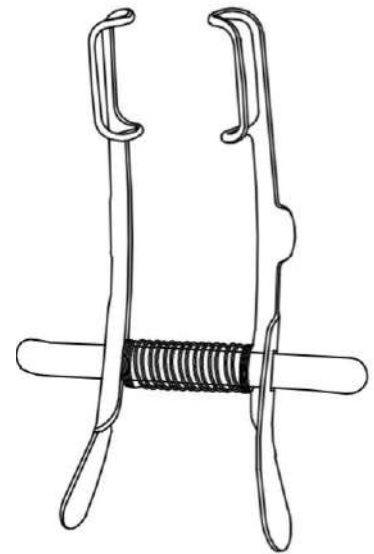

**MELLINGER**

40-1001	Fenestrated
40-1002	Solid

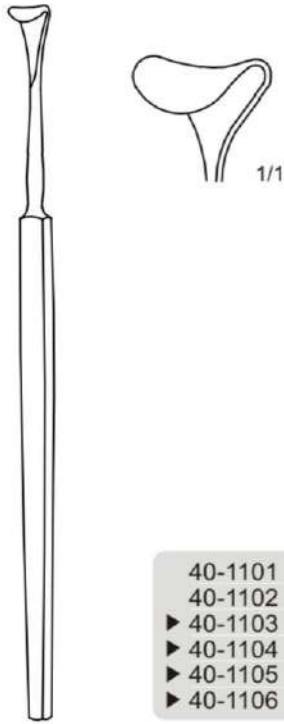

40-1101	8mm
40-1102	10mm
▶ 40-1103	12mm
▶ 40-1104	14mm
▶ 40-1105	16mm
▶ 40-1106	18mm

**DESMARRES**  
Eye Retractor

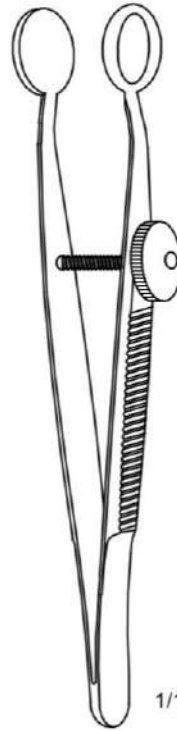

▶ 40-1200	9.0cm	8mm
-----------	-------	-----

**LAMBERT**

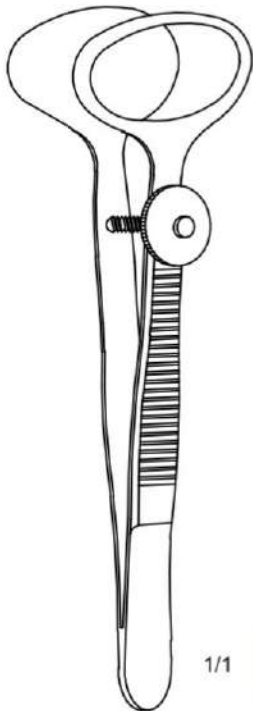

▶ 40-1301	9.0cm	20mm
▶ 40-1302	9.0cm	25mm
▶ 40-1303	9.0cm	30mm

**DESMARRES**

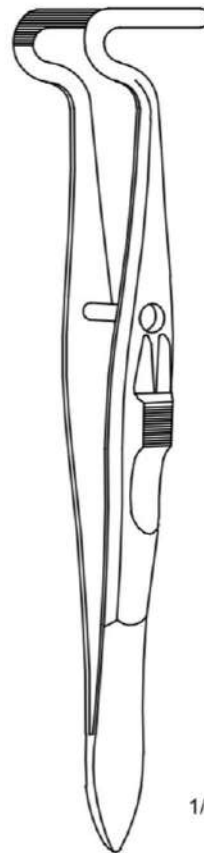

▶ 40-1400	10.8cm
-----------	--------

**BERKE**



1/2

**BOWMAN**  
Silver

▶ 40-1500 SET		
	Fig	mm
▶ 40-1501	0000/000	0.4/0.6
▶ 40-1502	00/0	0.7/0.8
▶ 40-1503	1/2	0.9/1.1
▶ 40-1504	3/4	1.3/1.4
▶ 40-1505	5/5	1.5/1.6



**WILDER**

40-1601	Fine
40-1602	Medium
40-1603	Strong

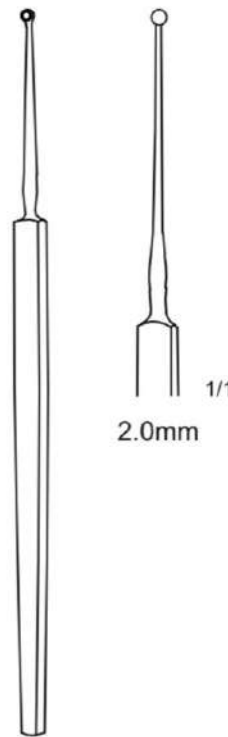

**MEYHOEFER**

1/1  
2.0mm

40-1700	0.5mm
▶ 40-1701	1.0mm
40-1702	1.5mm
40-1703	1.8mm
▶ 40-1704	2.0mm
40-1705	2.5mm
▶ 40-1706	3.0mm
40-1707	3.5mm
▶ 40-1708	4.0mm
40-1709	4.5mm

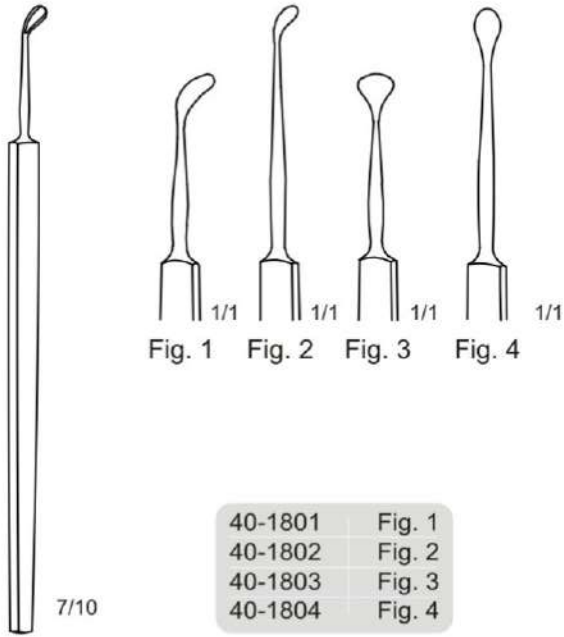

Fig. 1 Fig. 2 Fig. 3 Fig. 4

40-1801	Fig. 1
40-1802	Fig. 2
40-1803	Fig. 3
40-1804	Fig. 4

7/10

**KUHNT**

Corneal Scarifier

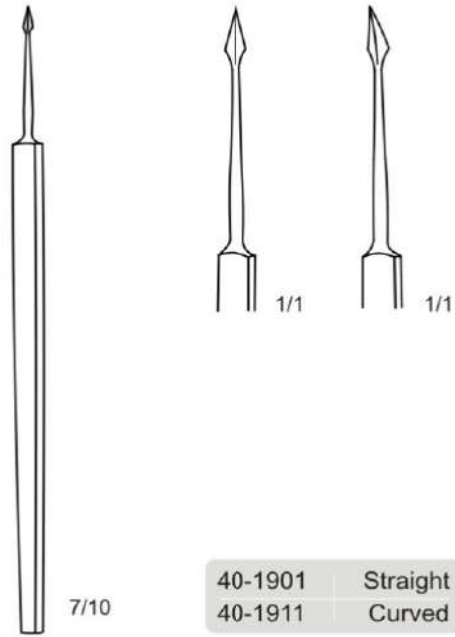

1/1 1/1

40-1901	Straight
40-1911	Curved

7/10

Foreign Body Needle

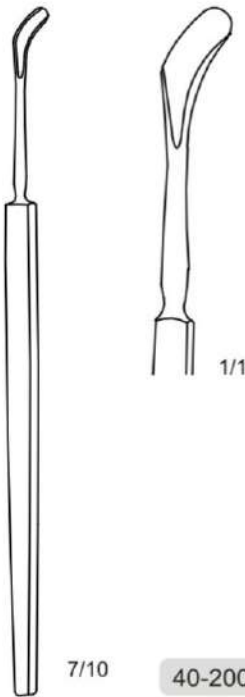

1/1

7/10

40-2000	Scarifier
---------	-----------

**GRAEFE**

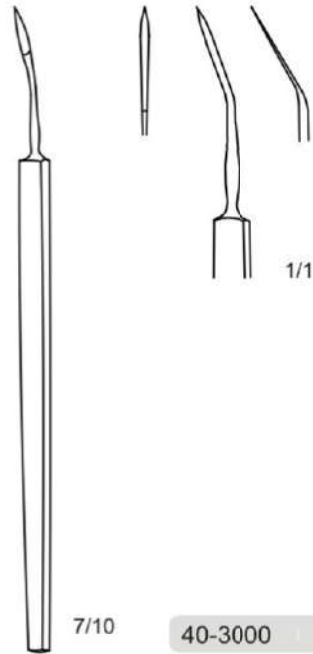

1/1

7/10

40-3000	Air Keratome
---------	--------------

**HAMBURG**

Air Keratome



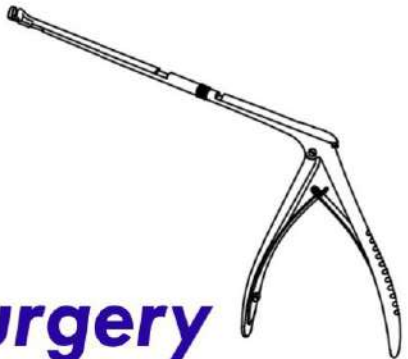

**ENT Surgery**  
ENT Surgery





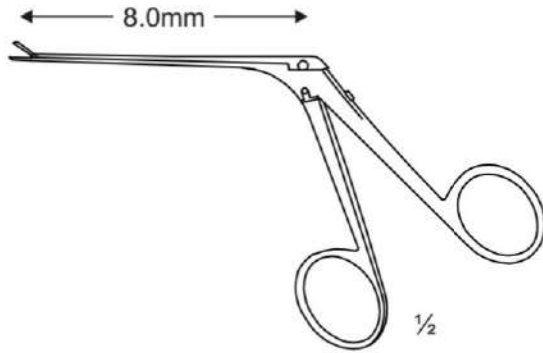

**ALLIGATOR**

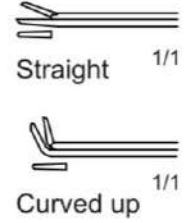
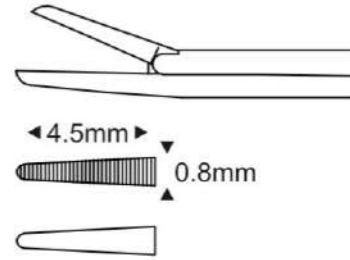

41-0101	4.5 x 0.8mm	Straight	Serrated
41-0102	4.5 x 0.8mm	Straight	Smooth
41-0103	8.5 x 0.8mm	Straight	Serrated
41-0111	4.5 x 0.8mm	Curved	Serrated

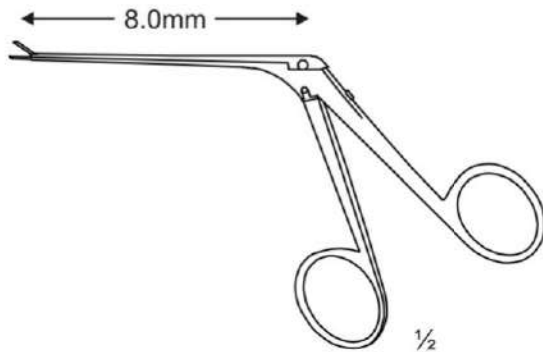

**ALLIGATOR**

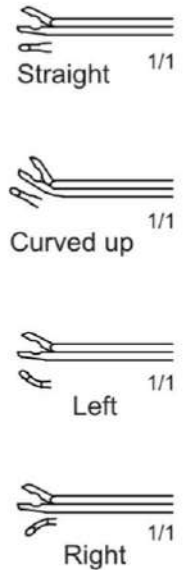
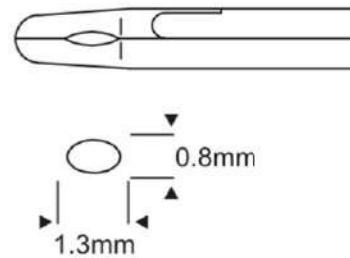

41-0201	1.3 x 0.8mm	Straight
41-0211	1.3 x 0.8mm	Curved up
41-0212	1.3 x 0.8mm	Left
41-0213	1.3 x 0.8mm	Right

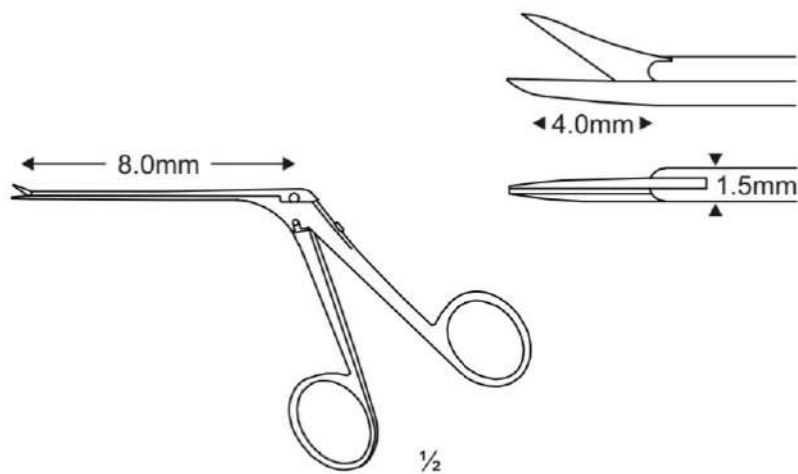

**BELLUCCI**

41-0301	1.5 x 4.0mm	Straight
41-0311	1.5 x 4.0mm	Curved up
41-0312	1.5 x 4.0mm	Left
41-0313	1.5 x 4.0mm	Right

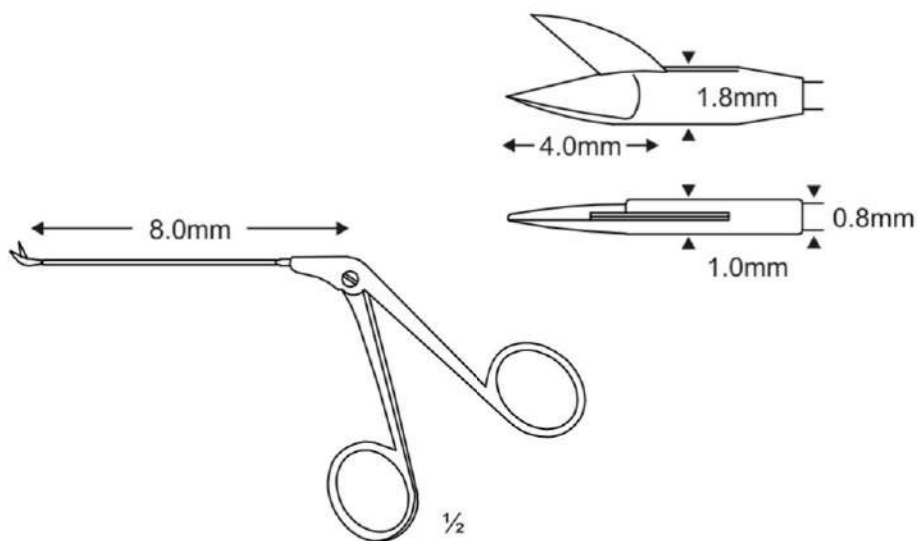
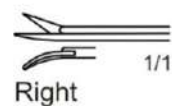
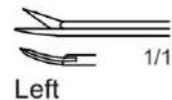
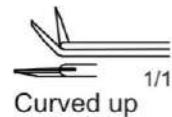
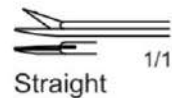

**WULLSTEIN**

41-0401	4.0 x 0.8mm	Straight
41-0411	4.0 x 0.8mm	Curved up
41-0412	4.0 x 0.8mm	Left
41-0413	4.0 x 0.8mm	Right

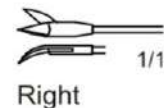
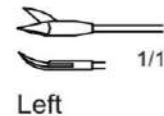

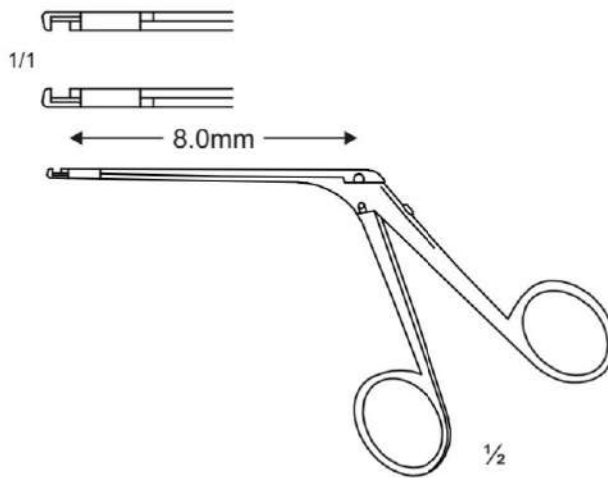
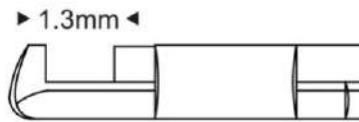

**HOUSE-DIETER**

41-0501	1.3mm	Down
41-0502	1.3mm	Up

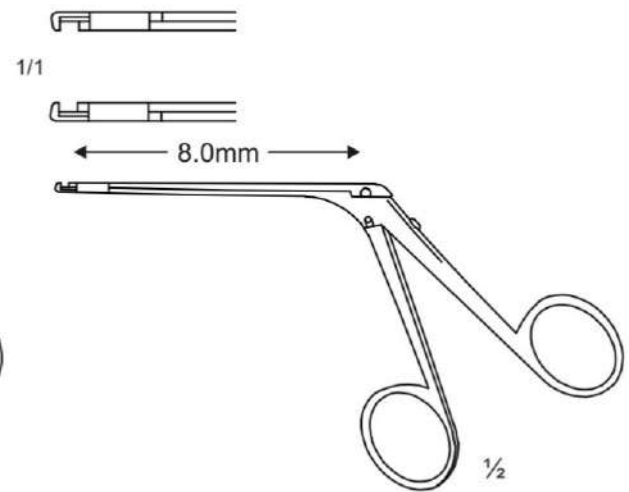

**HOUSE-DIETER**

41-0503	1.3mm	Left
41-0504	1.3mm	Right



1/1

**HARTMANN-WULLSTEIN**

41-0701 8.5cm

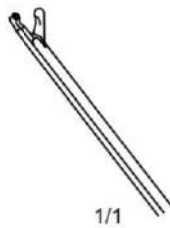

1/1

**HARTMANN-WULLSTEIN**

41-0702 8.5cm

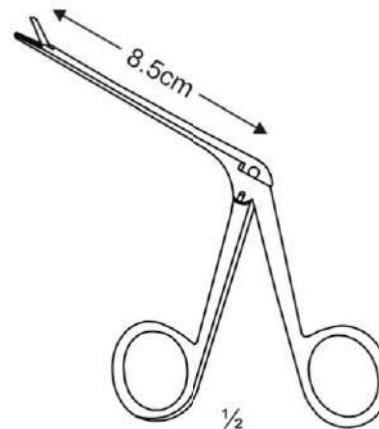

1/2

**HARTMANN-NOYES**

41-0900 9.0cm



1/1

**HARTMANN**

41-0801 8.5cm  
41-0802 14.0cm  
41-0803 16.0cm



1/1

**HARTMANN**

41-0810 8.5cm 1 x 2 teeth  
41-0820 14.0cm 1 x 2 teeth



1/1

ENT Surgery



1/1

**DUCKBILL**

41-1000 8.5cm



1/1

**WEINGARTNER**

41-1100 8.5cm

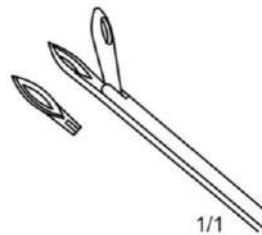

1/1

**STRUMPEL**

41-1200 8.5cm



1/1

**HARTMANN**

41-1300 8.5cm

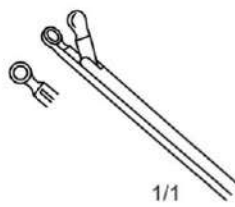

1/1

**HARTMANN**  
Straight

41-1401 8.5cm 2.0mm  
41-1402 8.5cm 2.5mm  
41-1403 8.5cm 3.0mm

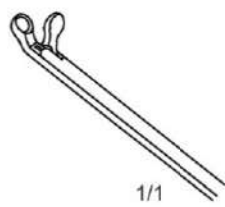

1/1

**HARTMANN**  
Curved up

41-1411 8.5cm 2.0mm  
41-1412 8.5cm 2.5mm  
41-1413 8.5cm 3.0mm



1/1

**HARTMANN**

41-1500 8.5cm

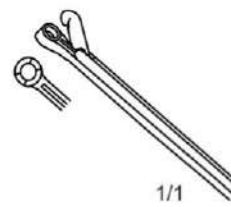

1/1

**HARTMANN-HOFFMANN**

41-1600 8.5cm

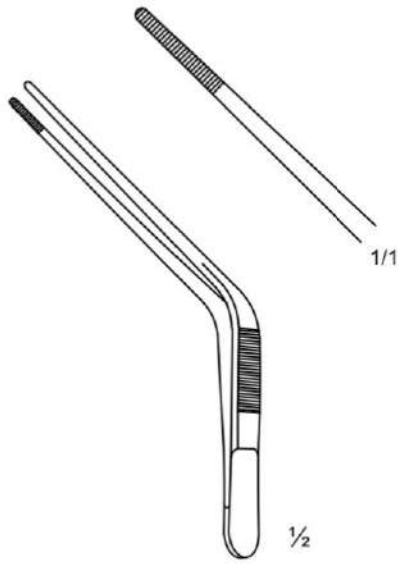

**TROELTSCH**

01-2201	11.0cm
01-2202	13.0cm

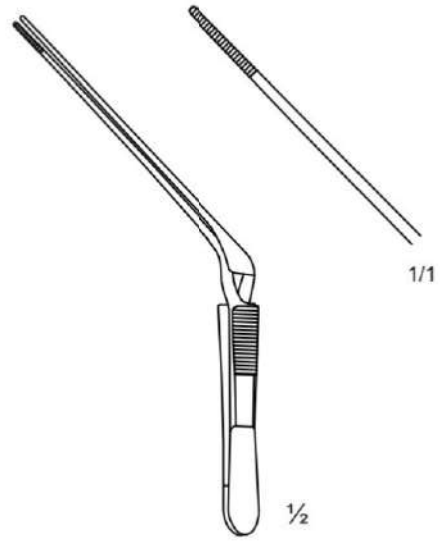

**TROELTSCH (WILDE)**

Cross Action

01-2401	13.0cm
---------	--------

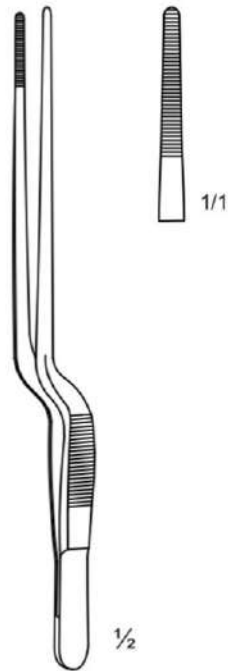

**JANSEN**

01-1701	14.0cm
01-1702	16.0cm

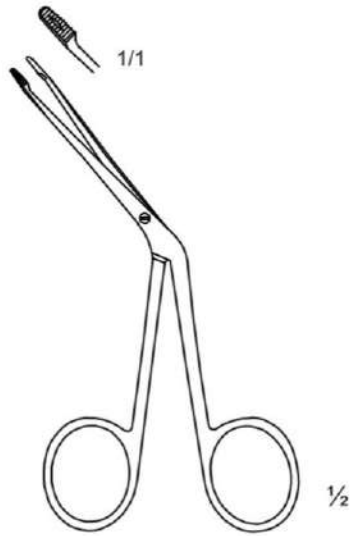

**HARTMANN**

41-1701 12.0cm

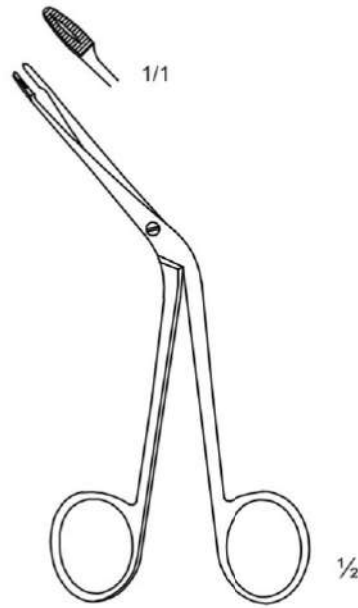

**HARTMANN-HOFFMANN**

41-1702 14.0cm

**Laminectomy Punches**

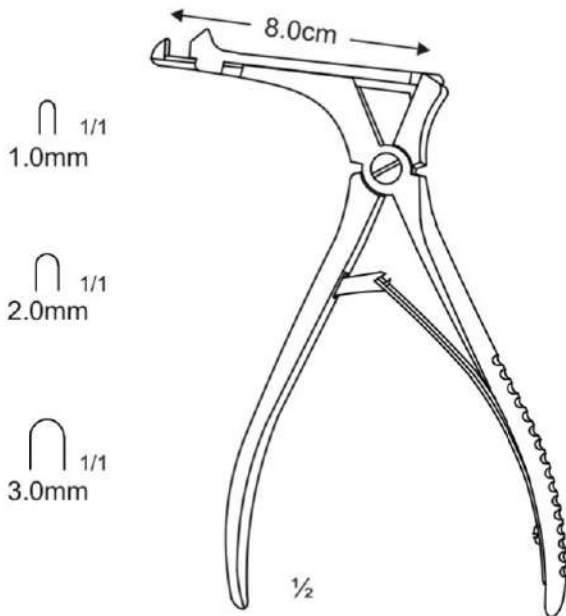

**CITELLY**

38-2501	1.0mm
38-2502	2.0mm
38-2503	3.0mm

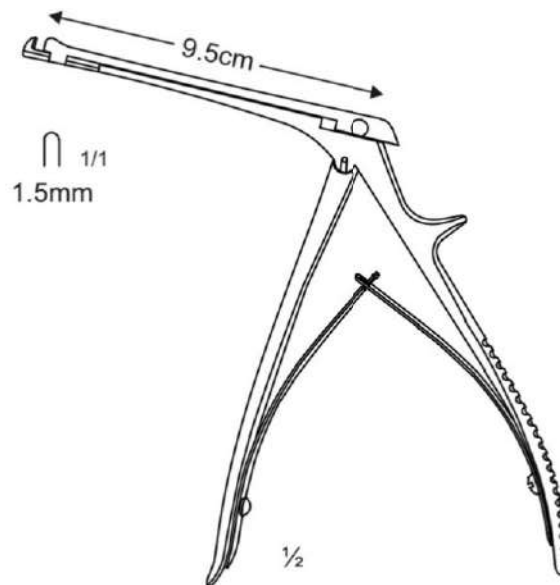

**BEYER**

38-2510



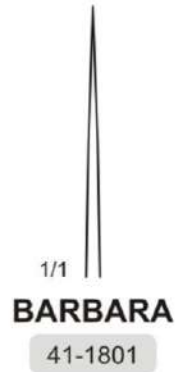

- 41-2001 0.3mm
- 41-2002 0.6mm
- 41-2003 1.0mm



- 41-2301 0.5mm
- 41-2302 1.0mm



- 41-2101 0.3mm
- 41-2102 0.6mm
- 41-2103 1.0mm
- 41-2104 1.2mm
- 41-2105 1.5mm
- 41-2106 2.0mm
- 41-2107 2.5mm



- 41-2201 0.3mm
- 41-2202 0.6mm
- 41-2203 1.0mm
- 41-2204 1.2mm
- 41-2205 1.5mm
- 41-2206 2.0mm
- 41-2207 2.5mm

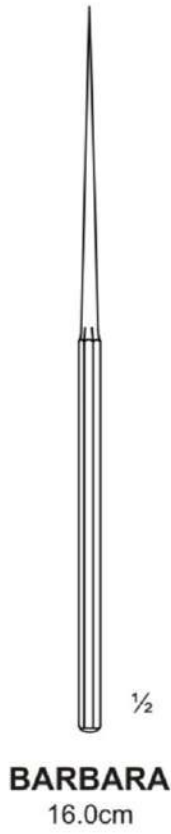





**BARBARA**  
16.0cm



41-2211	0.3mm
41-2212	0.6mm
41-2213	1.0mm



41-2221	0.3mm
41-2222	0.6mm
41-2223	1.0mm



**MCGEE**

41-2311	0.5mm
41-2312	1.0mm



**MCGEE**

41-2321	0.5mm
41-2322	1.0mm



**BARBARA**  
16.0cm



**BARBARA**  
41-1811



41-2011	0.3mm
41-2012	0.6mm
41-2013	1.0mm



41-2021	0.3mm
41-2022	0.6mm
41-2023	1.0mm



**ROSEN**  
41-1911



41-2111	0.3mm
41-2112	0.6mm
41-2113	1.0mm



41-2121	0.3mm
41-2122	0.6mm
41-2123	1.0mm



**BUCK**  
16.0cm  
41-2400



**POLITZER**  
15.0cm  
41-2500

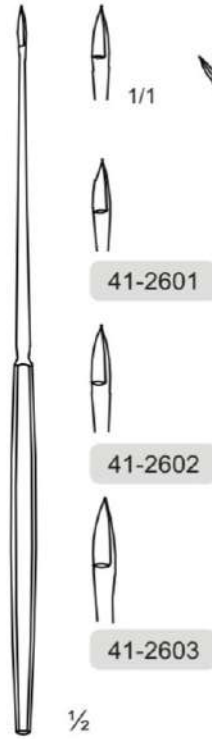

**SEXTON**  
18.0cm

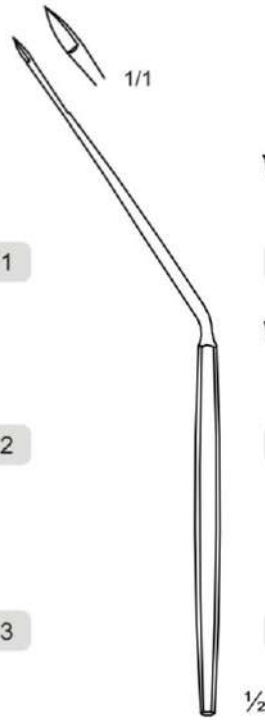

**SEXTON**  
17.0cm

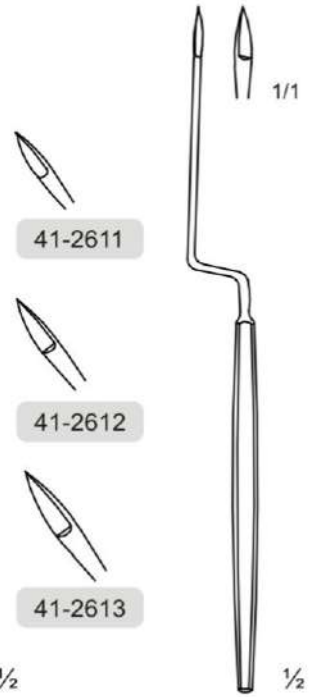

**GERZOG**  
17.0cm  
41-2700

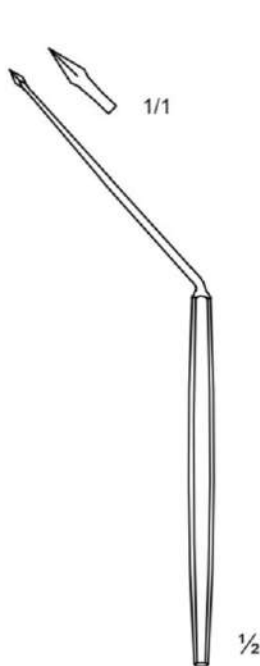

**POLITZER**  
16.0cm

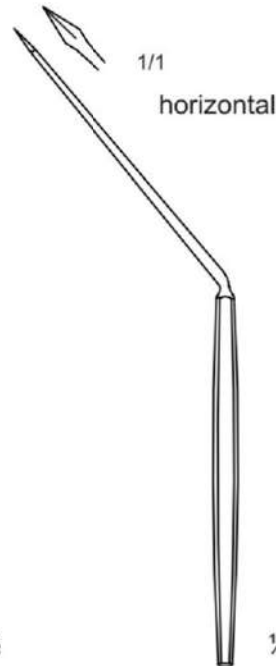

**POLITZER**  
16.0cm



**LUCAE**  
18.0cm



**LUCAE**  
18.0cm

# Ear Knives

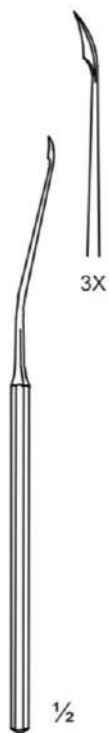

**SCHUKNECHT**  
16.0cm  
41-3000



**WULLSTEIN**  
16.0cm  
41-3100



**TABB**  
16.0cm  
41-3200



**PLESTER**  
16.0cm  
41-3300



**ROSEN**  
16.0cm

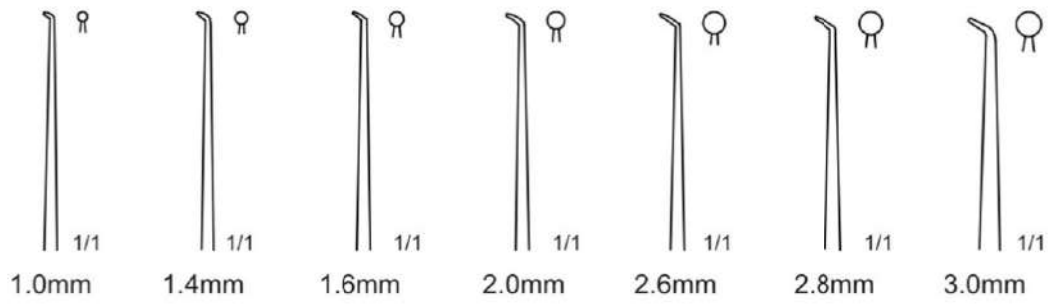

41-3401	1.0mm
41-3402	1.4mm
41-3403	1.6mm
41-3404	2.0mm
41-3405	2.6mm
41-3406	2.8mm
41-3407	3.0mm

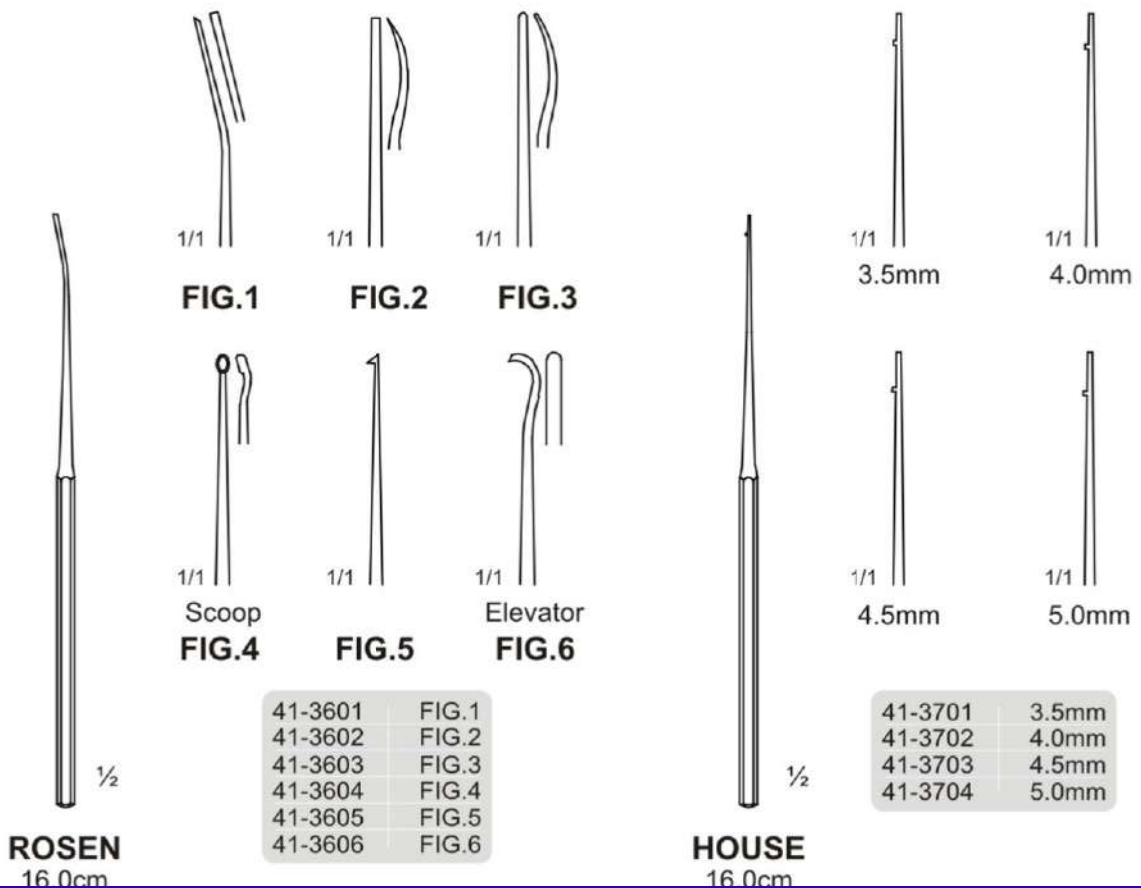
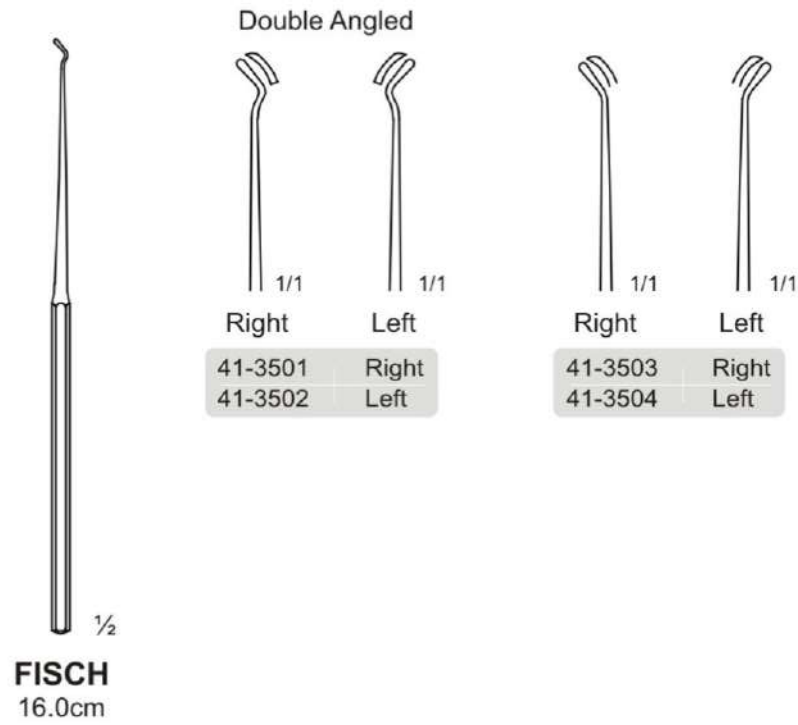



**LUCAE**  
14.0cm

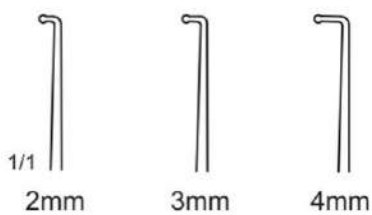

41-3801	2.0mm
41-3802	3.0mm
41-3803	4.0mm

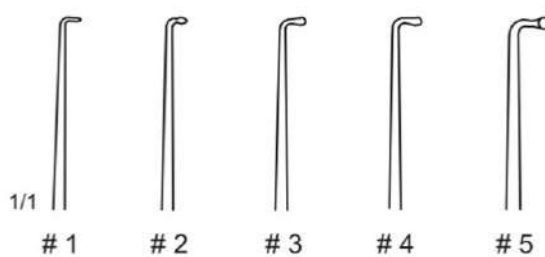

41-3901	# 1
41-3902	# 2
41-3903	# 3
41-3904	# 4
41-3905	# 5



**WAGENER**  
14.0cm

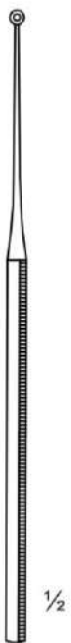

**BUCK**  
16.0cm

	1/1							
		# 000	# 00	# 0	# 1	# 2	# 3	# 4
		41-4001	41-4002	41-4003	41-4004	41-4005	41-4006	41-4007
		41-4011	41-4012	41-4013	41-4014	41-4015	41-4016	41-4017
	1/1							
		# 000	# 00	# 0	# 1	# 2	# 3	# 4
		41-4101	41-4102	41-4103	41-4104	41-4105	41-4106	41-4107
		41-4111	41-4112	41-4113	41-4114	41-4115	41-4116	41-4117

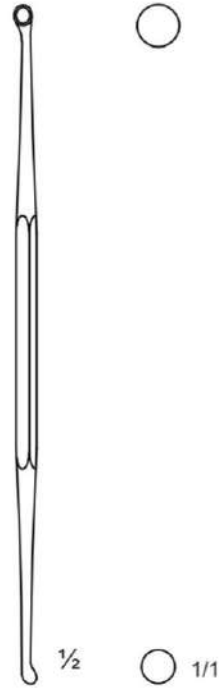

**JANSEN**

41-4200 15.0cm

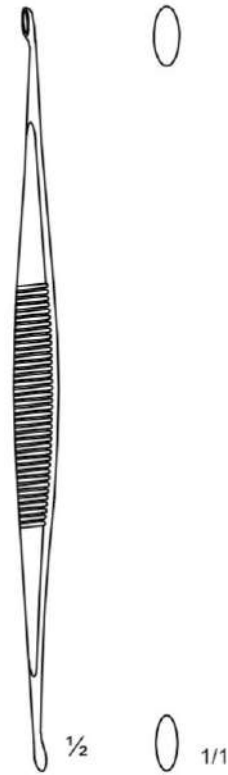

**BARTH**

41-4300 18.0cm

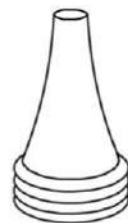

**TOYNBEE**



# 1



# 2



# 3



# 4



# 5

▶ 41-4400	Set	
41-4401	4.0mm	# 1
41-4402	5.5mm	# 2
41-4403	7.0mm	# 3
41-4404	8.5mm	# 4
41-4405	10.0mm	# 5



# Nasal Speculums

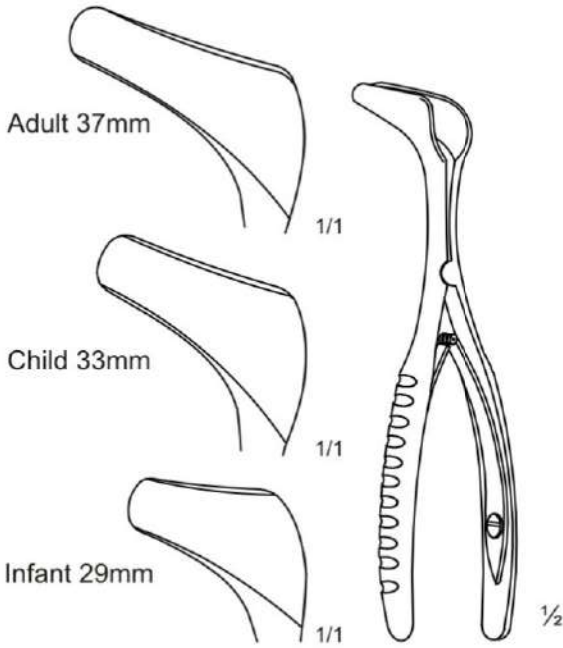

**HARTMANN**

▶ 42-0201	29mm	Infant
▶ 42-0202	33mm	Child
▶ 42-0203	37mm	Adult

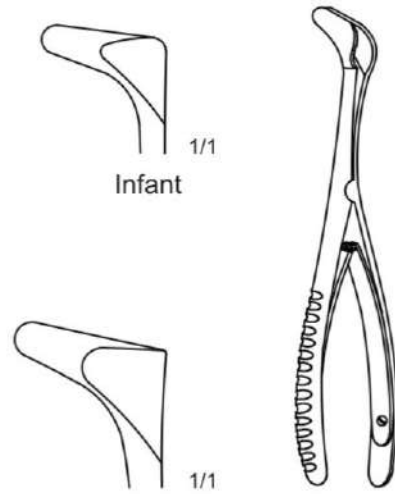

Child **HALLE-TIECK**  
13.0cm

42-0210	Infant
42-0220	Child

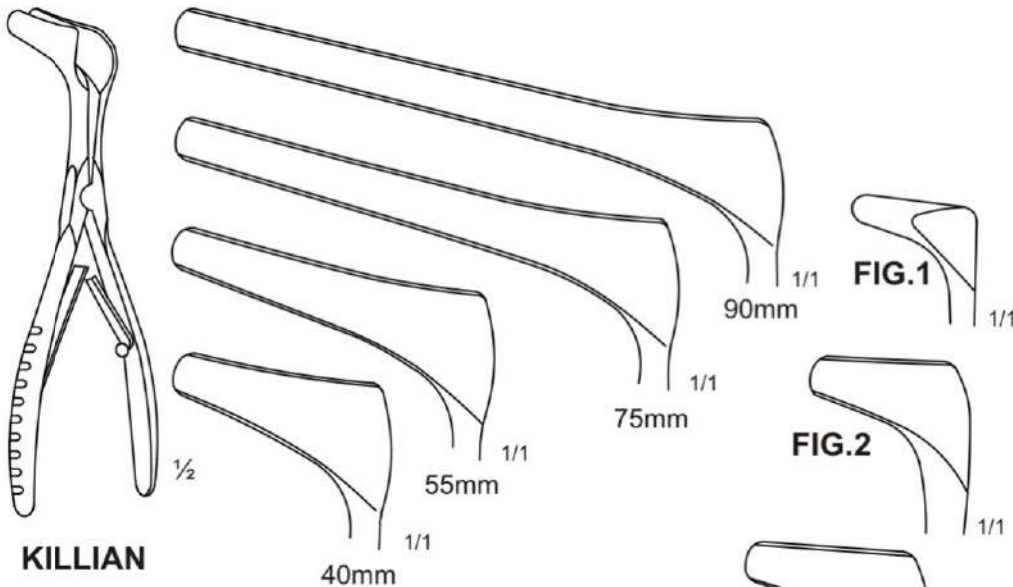

**KILLIAN**

42-0301	40mm
▶ 42-0302	55mm
▶ 42-0303	75mm
▶ 42-0304	90mm

42-0310	40mm
42-0320	55mm
42-0330	75mm
42-0340	90mm



**SCREW STOP**

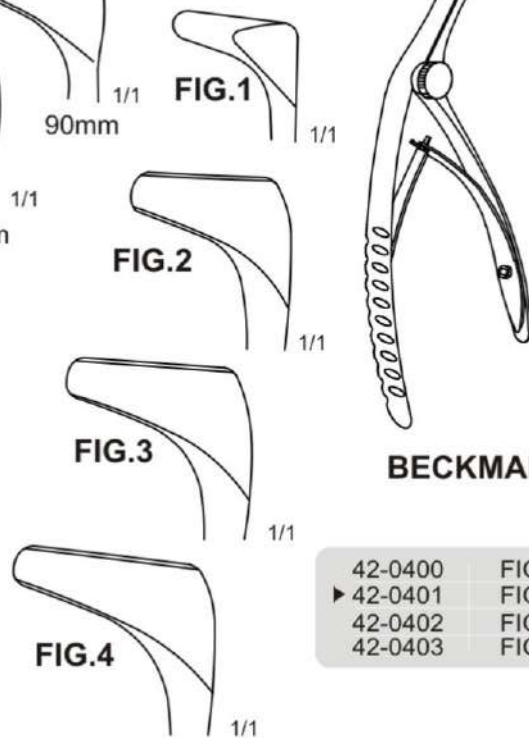

**BECKMAN**

42-0400	FIG.1
▶ 42-0401	FIG.2
42-0402	FIG.3
42-0403	FIG.4



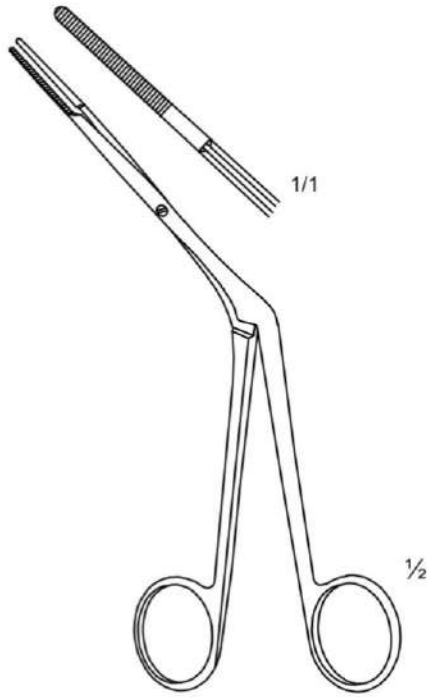

**WESTMACOTT**

42-0500 20.0cm

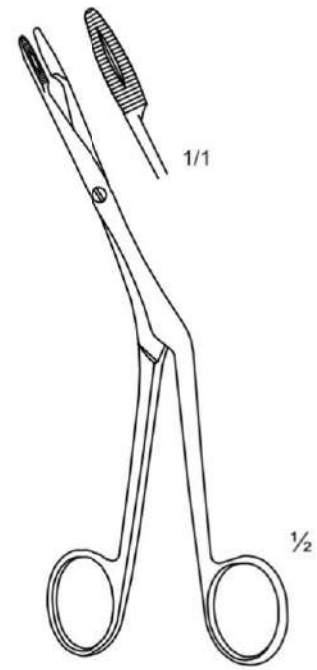

**HEYMANN-KNIGHT**

42-0601 18.0cm

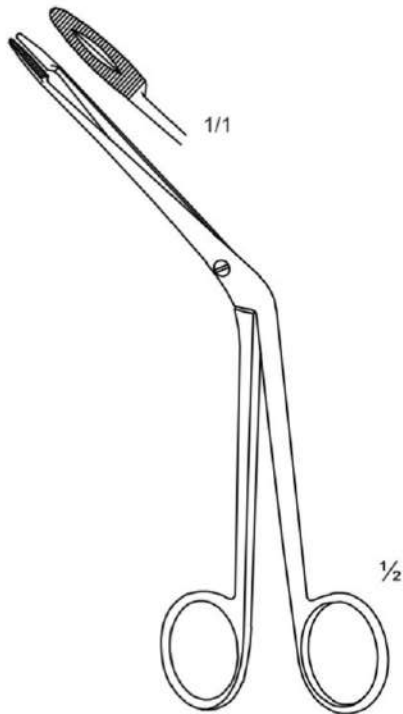

**HARTMANN**

42-0602 20.0cm

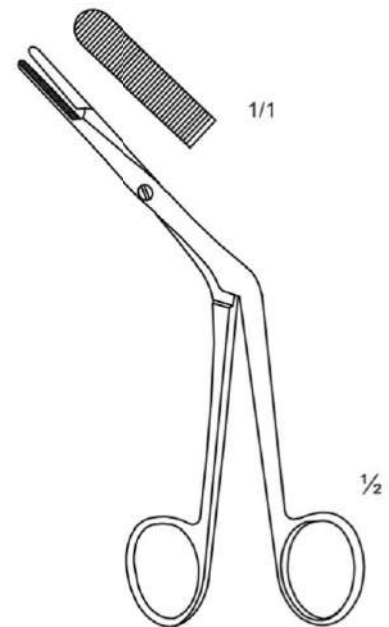

**KILLIAN**

42-0610 17.0cm

# Nasal Cutting Forceps



1/1  
5mm

1/1  
7mm

1/1  
9mm

1/1  
11mm

12.5cm

1/2

42-0701	5.0mm
42-0702	7.0mm
42-0703	9.0mm
42-0704	11.0mm

**HARTMANN**

1/1  
2.5mm

1/1  
3.5mm

1/1  
4.0mm

**GRUNWALD**  
Straight

42-0801	2.5mm
42-0802	3.5mm
42-0803	4.0mm

1/1  
6.0mm

1/1  
7.5mm

1/1  
9.0mm

42-0901	6.0mm
42-0902	7.5mm
42-0903	9.0mm

**SCHMEDEN**

1/1  
4.0mm

42-1000	4.0mm
---------	-------

**GRUNWALD**  
Curved Up

1/1  
2.2mm

1/1  
2.6mm

1/1  
3.0mm

1/1  
3.4mm

42-1101	2.2mm
42-1102	2.6mm
42-1103	3.0mm
42-1104	3.4mm

**MYLES**

1/1  
1.0mm



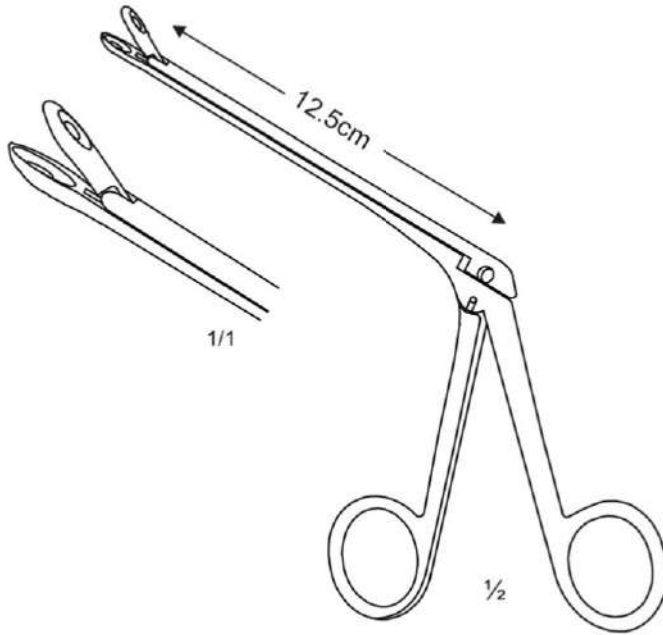

1/1  
2.0mm

42-1201	1.0mm
42-1202	2.0mm

**STRUYCKEN**



**WEIL-BLAKESLEY**  
Straight

-  38-4001 3.0mm
-  38-4002 3.6mm
-  38-4003 4.2mm
-  38-4004 4.8mm
-  38-4005 5.8mm



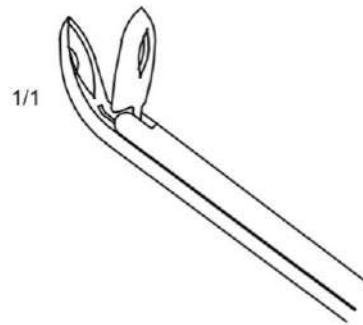

**WATSON-WILLIAMS**

42-1300 12.5cm



**WEIL-BLAKESLEY**  
Curved Up

-  38-4012 3.6mm
-  38-4013 4.2mm
-  38-4014 4.8mm

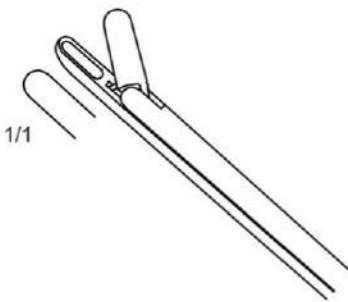

**WATSON-WILLIAMS**  
Straight

42-1401 12.5cm

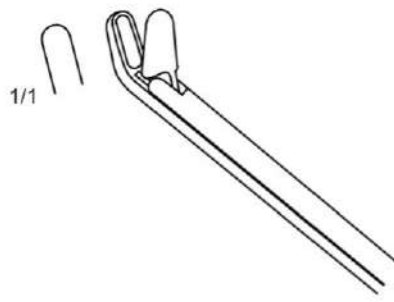

**WATSON-WILLIAMS**  
Curved Up

42-1411 12.5cm

# Nasal Cutting Forceps

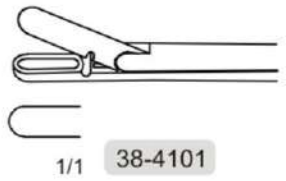

1/1 38-4101

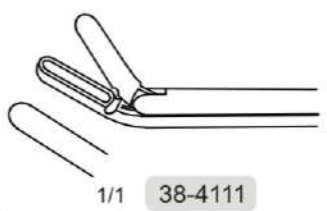

1/1 38-4111

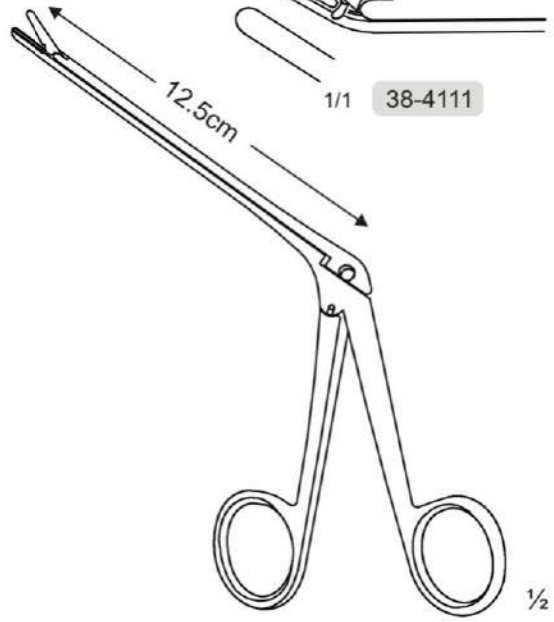

**TAKAHASHI**

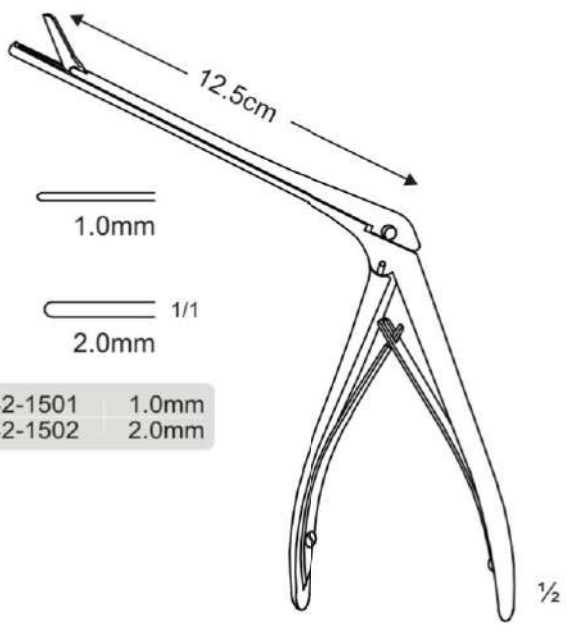

**STRUYCKEN**

1.0mm	
2.0mm	1/1
42-1501	1.0mm
42-1502	2.0mm

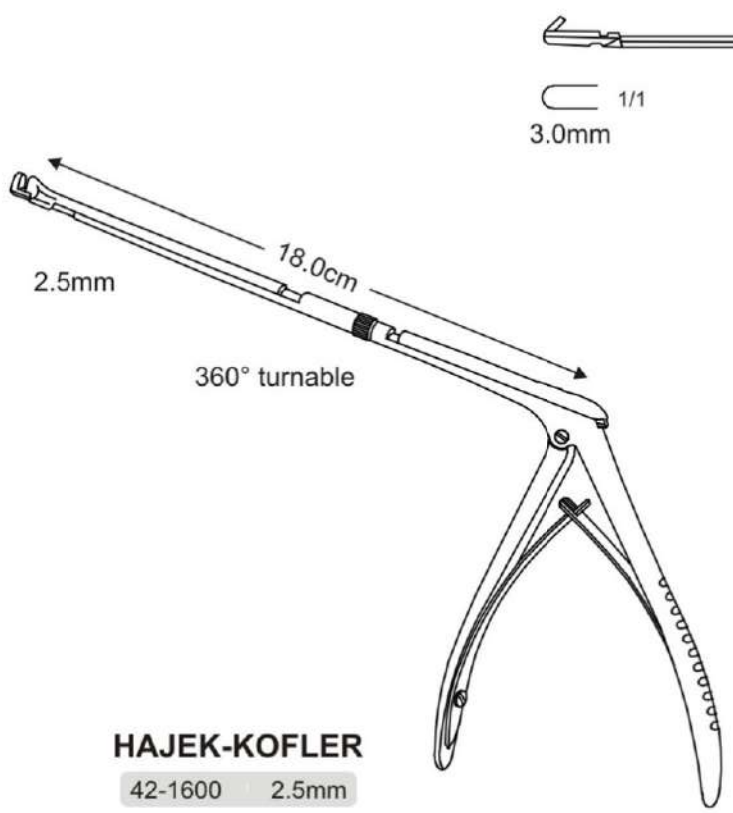

**HAJEK-KOFLER**

42-1600 2.5mm

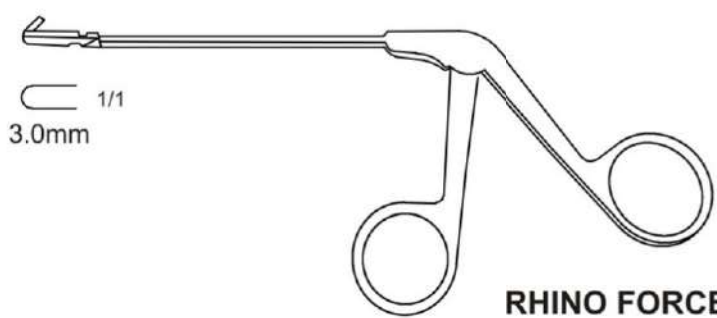

**RHINO FORCE STAMNBERGER**

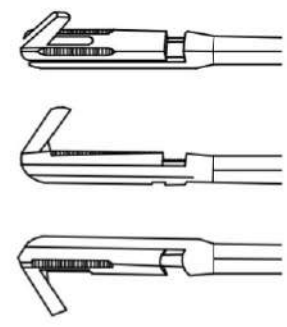

42-1701	Up Bite
42-1702	Right Bite
42-1703	Left Bite



38-2601	3.0mm
38-2602	4.0mm
38-2603	5.0mm
38-2604	6.0mm

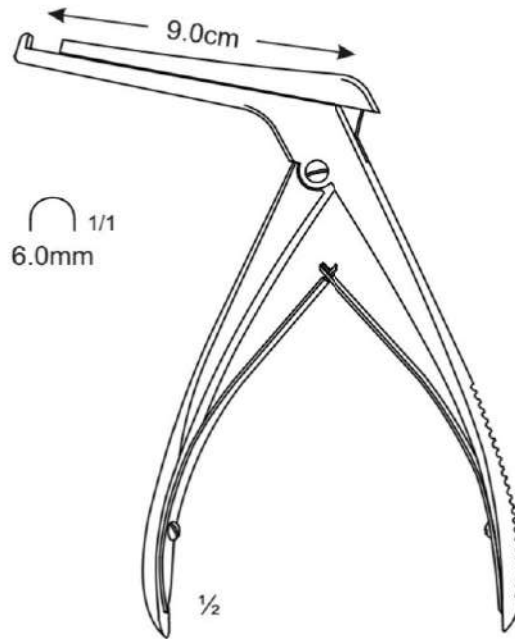

**KERRISON**  
Upwards cutting 90°

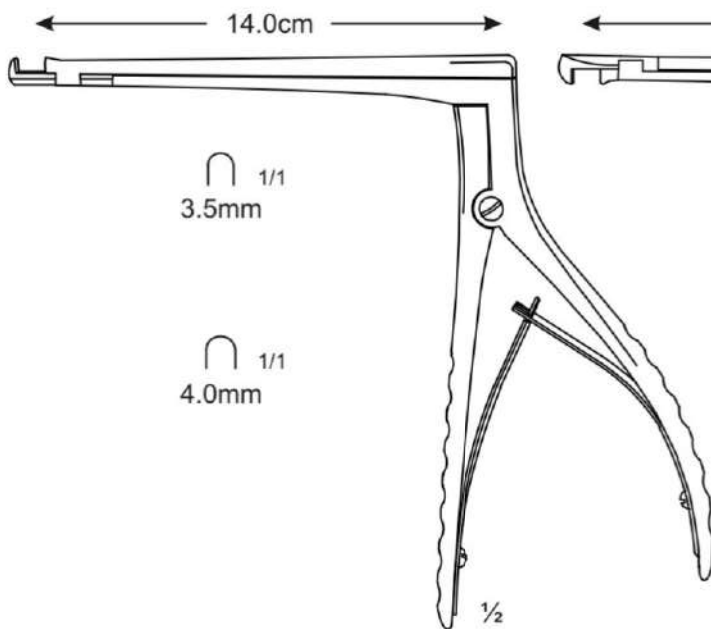

**HAJEK-KOFLER**  
Upwards cutting 90°

38-2701	3.5mm
38-2702	4.0mm

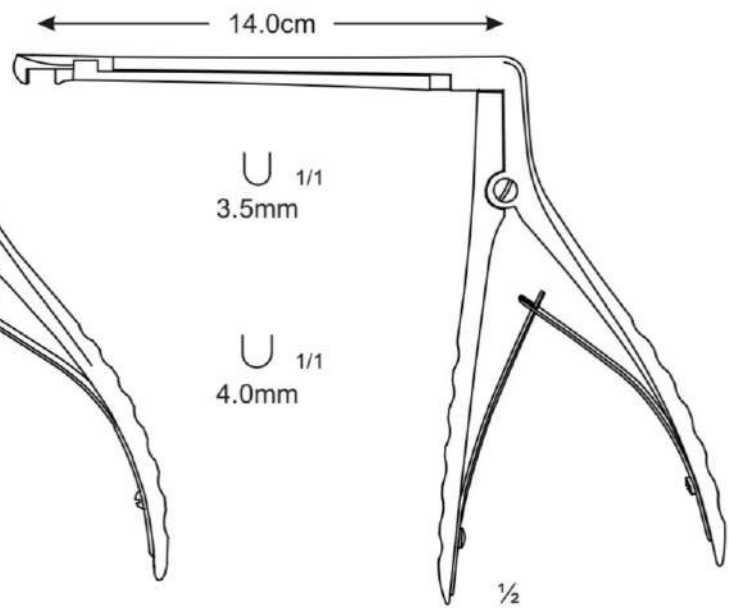

**HAJEK-KOFLER**  
Downwards cutting 90°

38-2711	3.5mm
38-2712	4.0mm



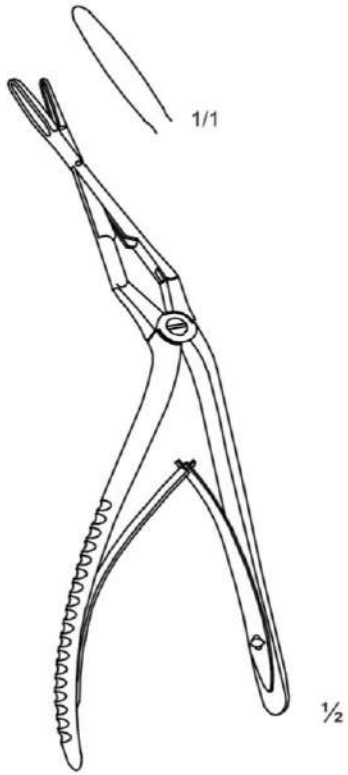

**MIDDLETON-JANSEN**

Punch

42-1810 19.0cm

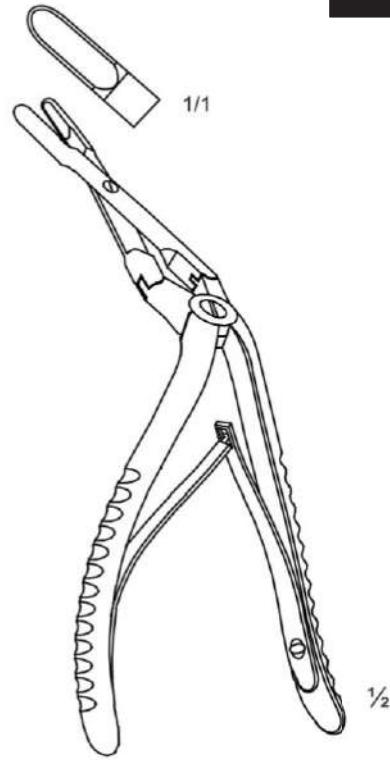

**MIDDLETON-JANSEN**

Rongeur

42-1820 19.0cm

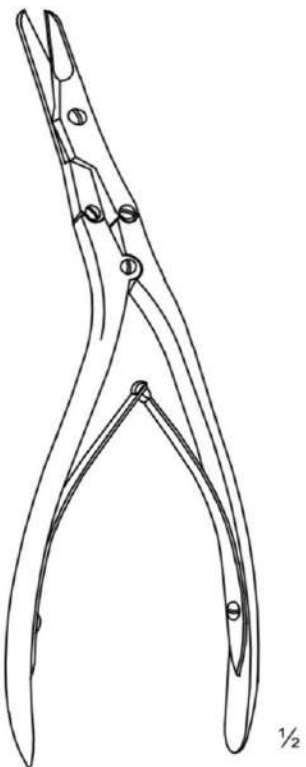

**BECKER-SCHERE**

Scissor

42-1900 20.0cm

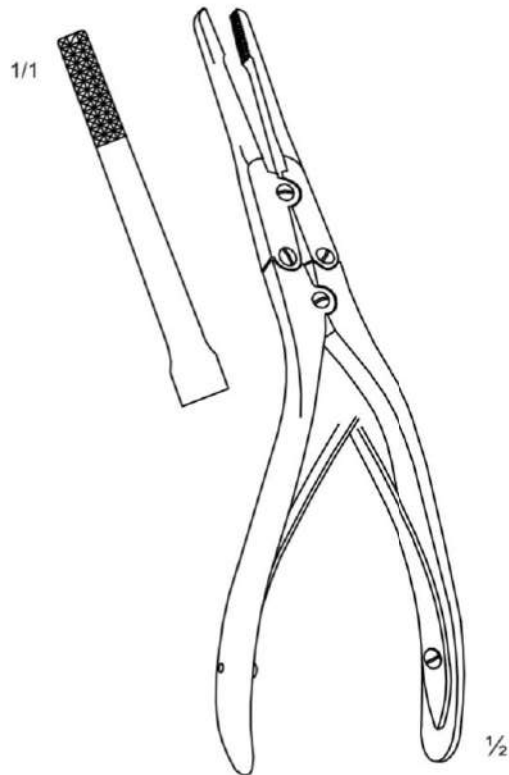

**RUBIN**

Forceps

42-2000 20.0cm



**JOSEPH**

1/2

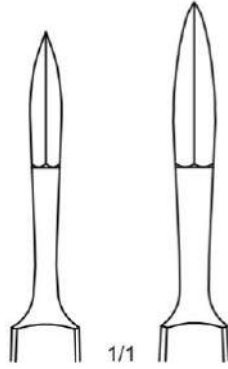

1/1

42-2101	14.5cm	Straight
42-2102	16.0cm	Straight

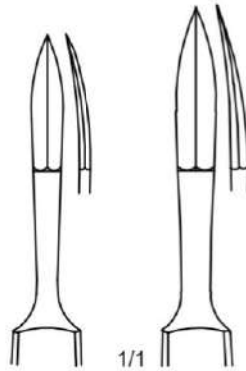

1/1

42-2111	14.5cm	Curved
42-2112	16.0cm	Curved



**JOSEPH**

1/2

42-2201	15.0cm
---------	--------

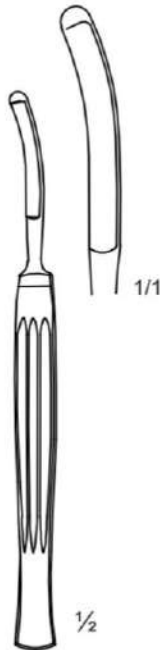

**CONVERS**

1/2

42-2211	16.0cm
---------	--------

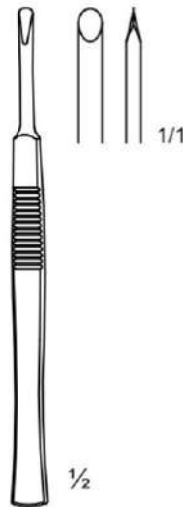

**COTTLE**

1/2

42-2202	15.0cm
---------	--------

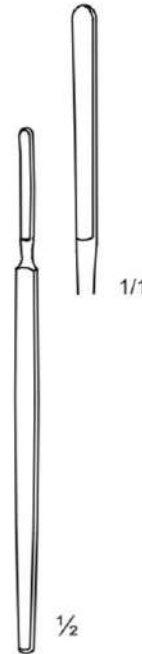

**COTTLE**

1/2

42-2203	15.0cm
---------	--------

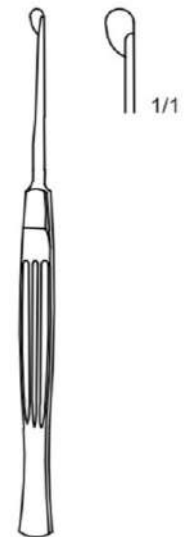

**FREER**

1/1

42-2204	15.0cm
---------	--------



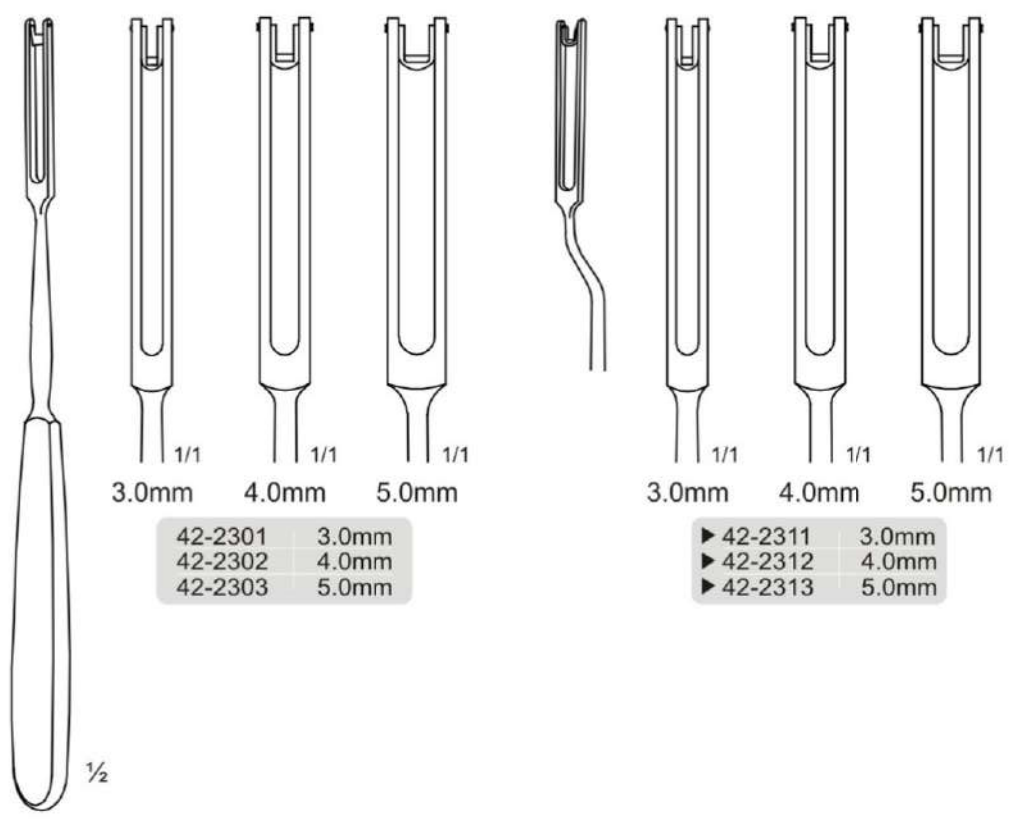

42-2301	3.0mm
42-2302	4.0mm
42-2303	5.0mm

▶ 42-2311	3.0mm
▶ 42-2312	4.0mm
▶ 42-2313	5.0mm

**BALLENGER**

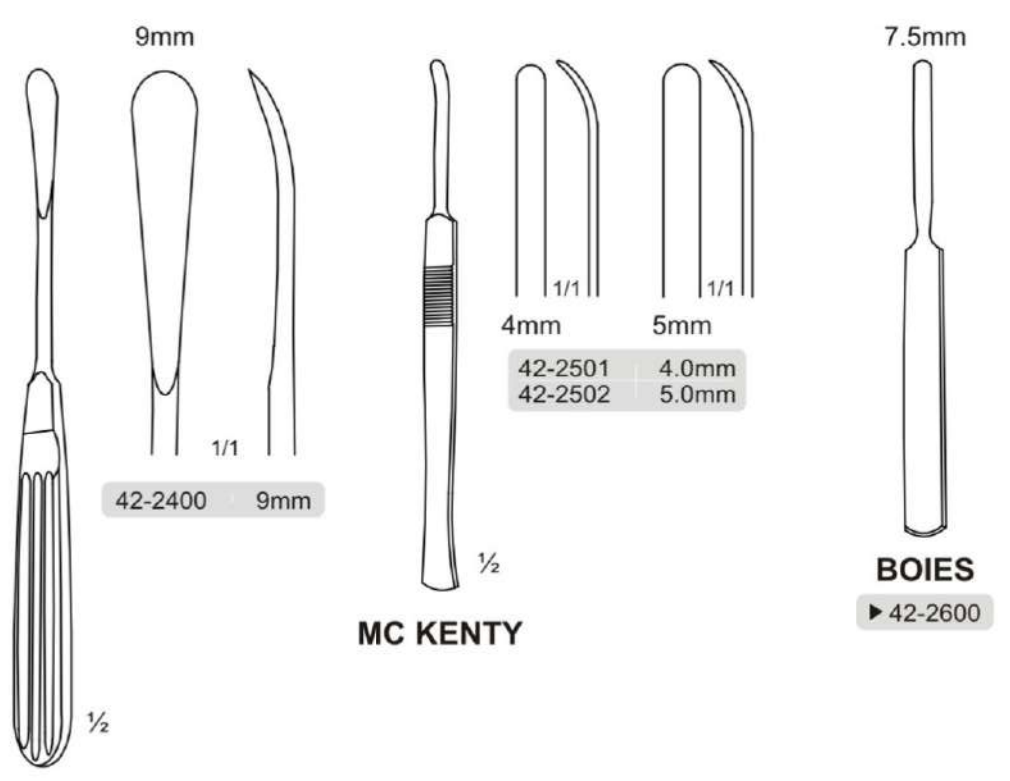

42-2400	9mm
---------	-----

42-2501	4.0mm
42-2502	5.0mm

▶ 42-2600
-----------

**COTTLE**

**MC KENTY**

**BOIES**

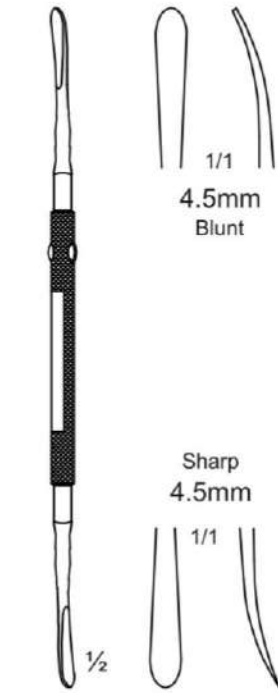

**FREER**

▶ 37-0801 19.0cm

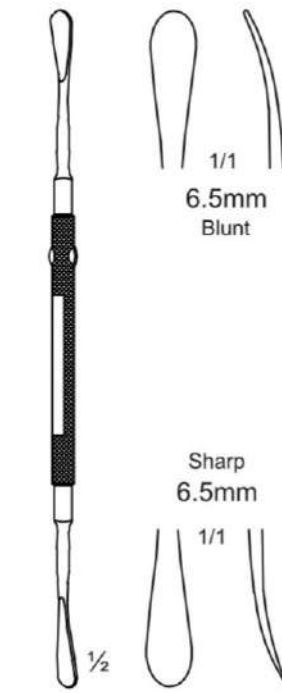

**FREER**

▶ 37-0802 19.0cm

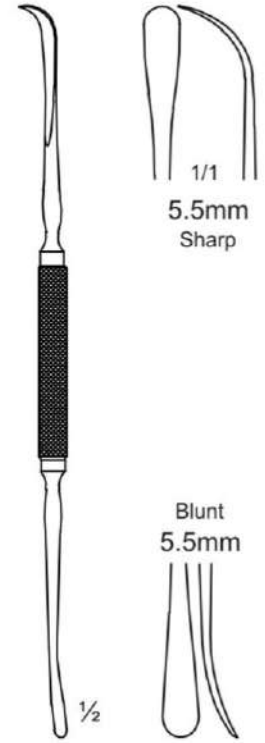

**FREER**

▶ 37-0803 19.0cm



**FREER**

▶ 37-0804 19.0cm



**FREER**

▶ 37-0805 19.0cm

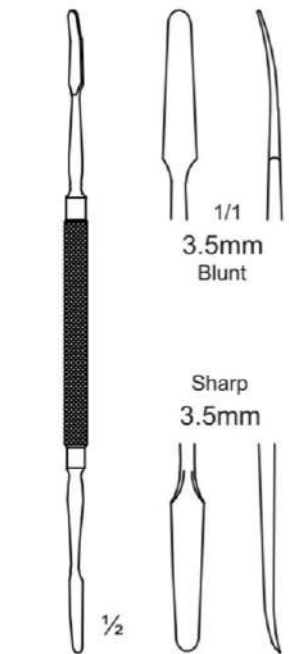

**KILLIAN**

▶ 37-0806 18.0cm



4.5mm



3.5mm

**FREER**

▶ 42-2700 21.0cm



1/2

**JOSEPH**

42-2801	2.0mm
42-2802	3.0mm
42-2803	4.0mm
42-2804	5.0mm
42-2805	3.5mm

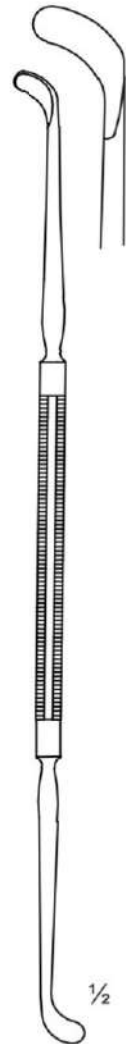

1/1

1/2

**PENNINGTON**

42-2900 21.0cm

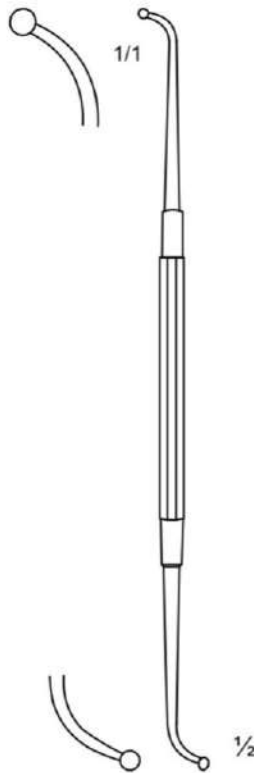

**Double Ball Hook**

42-3000 18.0cm

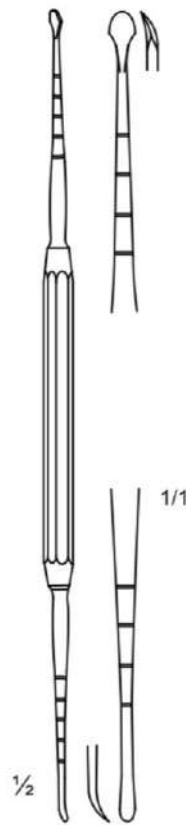

**MASSING**

42-3010 21.0cm

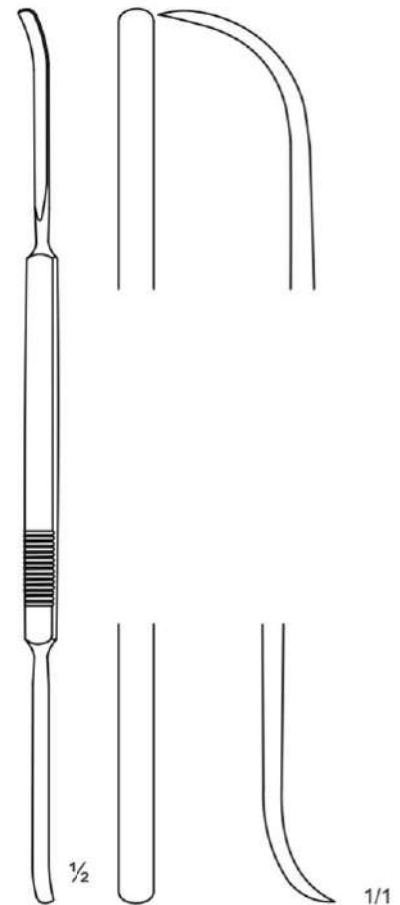

**COTTLE**

42-3020 23.0cm

# Osteotomes



2.0mm



**HEXAGONAL**

▶ 42-3100 2.0mm

4.0mm



**FREER**  
Chisel

▶ 42-3201 Straight  
42-3211 Curved

4.0mm

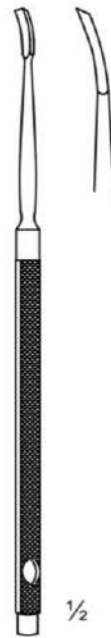

**FREER**  
Chisel

6.0mm

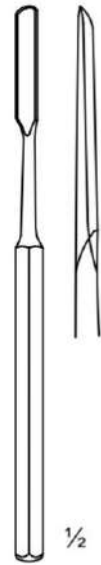

**FREER**  
Gouge

▶ 42-3202 6.0mm



**COTTLE**

with depth marking

42-3301	4.0mm
42-3302	6.0mm
42-3303	8.0mm
42-3304	10.0mm
42-3305	12.0mm



**COTTLE**

with depth marking

▶ 42-3312 6mm

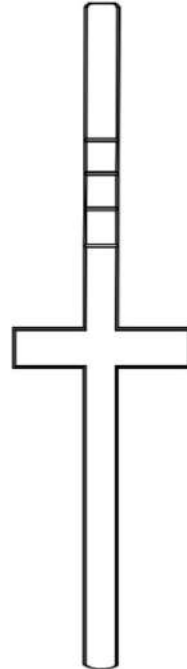

**COTTLE**

42-3401	4.0mm
42-3402	7.0mm
42-3303	9.0mm
42-3304	12.0mm

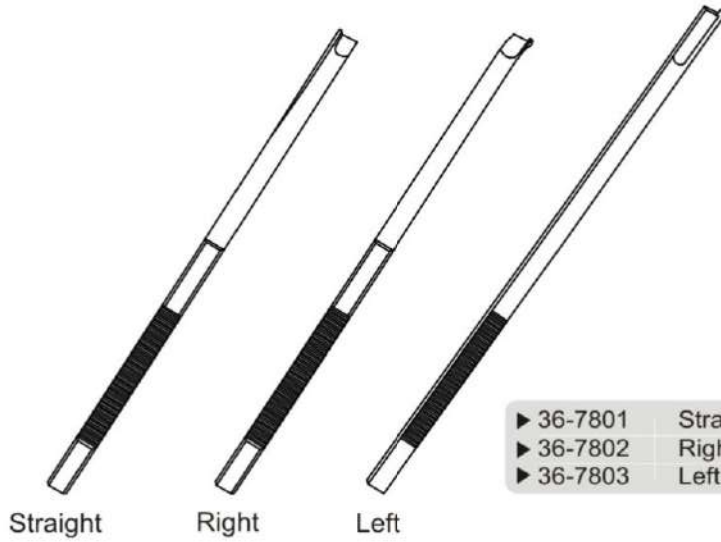

Straight Right Left  
**ANDERSON-NEIVERT**

- ▶ 36-7801 Straight
- ▶ 36-7802 Right
- ▶ 36-7803 Left

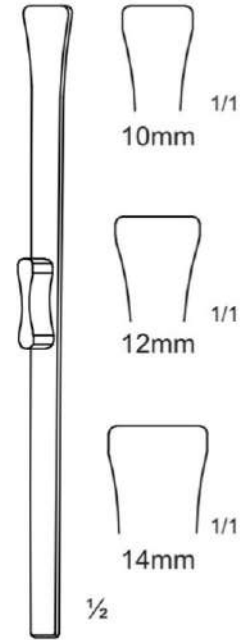

**RUBIN**

- ▶ 42-3501 10mm
- ▶ 42-3502 12mm
- ▶ 42-3503 14mm

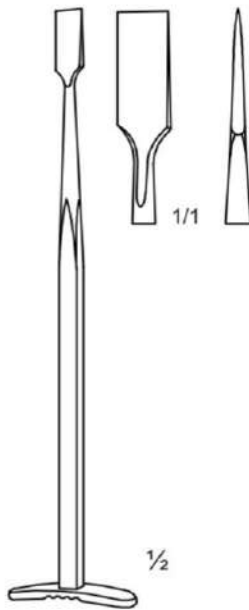

**SMILLIE**

- ▶ 36-7901 17.0cm

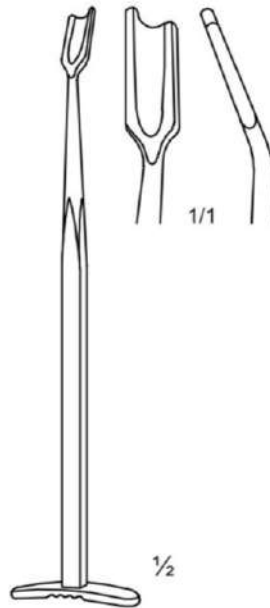

**SMILLIE**

- ▶ 36-7902 17.0cm

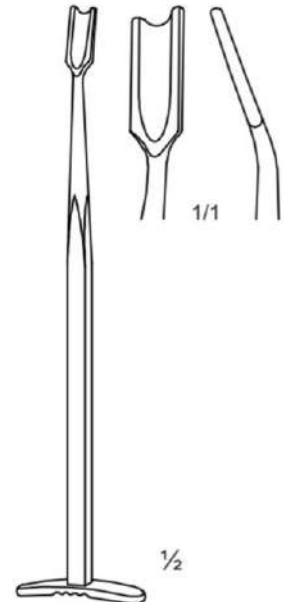

**SMILLIE**

- ▶ 36-7903 17.0cm



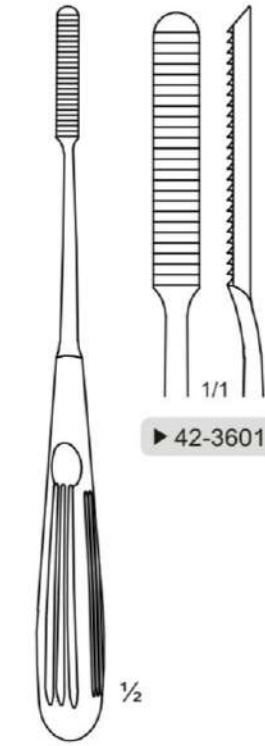

▶ 42-3601

COTTLE

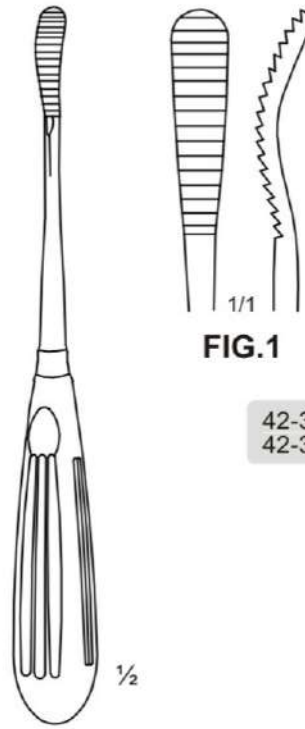

FIG.1

FIG.2

42-3602 FIG.1  
42-3603 FIG.2

AUFRICHT

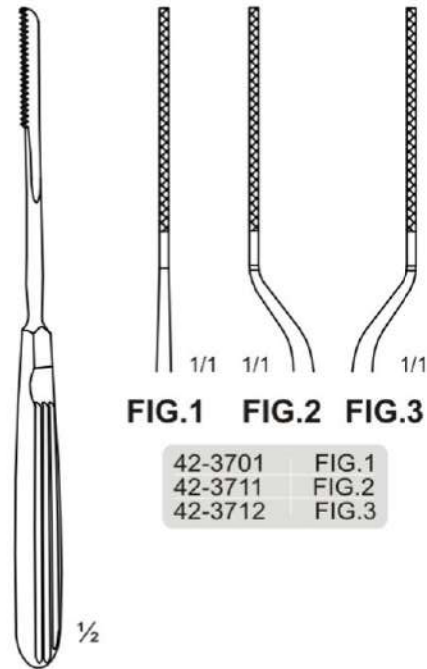
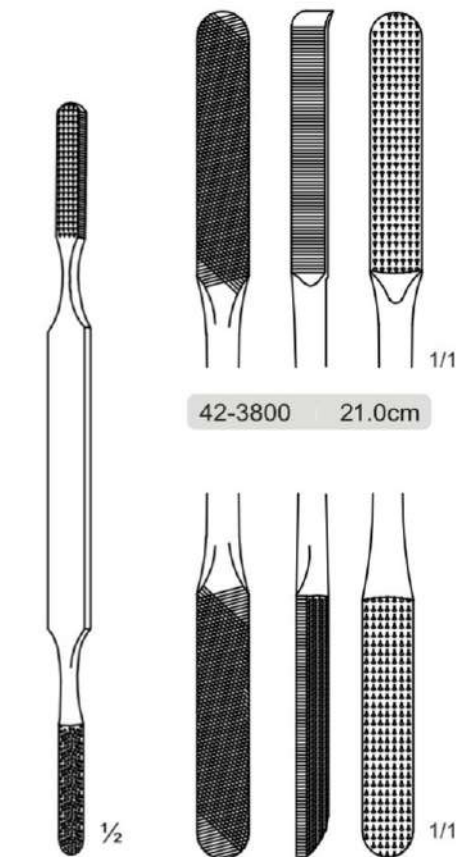

FIG.1 FIG.2 FIG.3

42-3701 FIG.1  
42-3711 FIG.2  
42-3712 FIG.3

JOSEPH



42-3800 21.0cm

FOMON



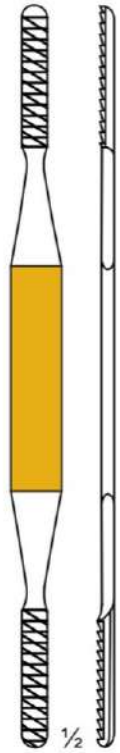

FOMON



42-3901



42-3902



42-3903



42-3904



42-3905

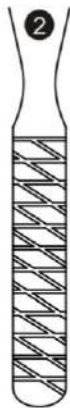

1/1



1/1



1/1



1/1



1/1



MILLER

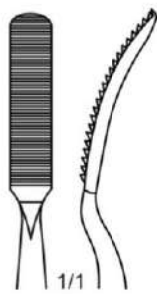

1/1



1/1

41-4000 19.0cm

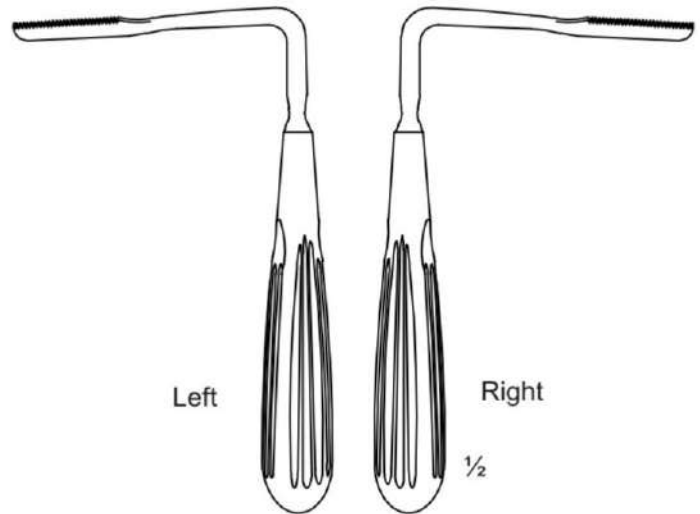

JOSEPH

42-4101 Left  
42-4102 Right

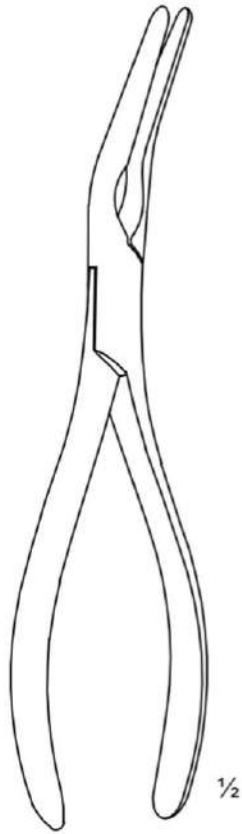

**ASH**  
Septum Forceps

▶ 42-4200 23.0cm

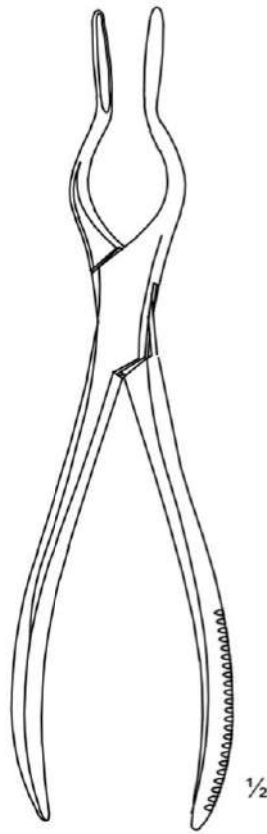

**WALSHAM**  
Septum Forceps

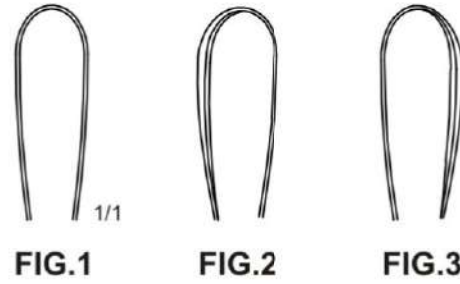

42-4301	FIG.1
42-4302	FIG.2
42-4303	FIG.3

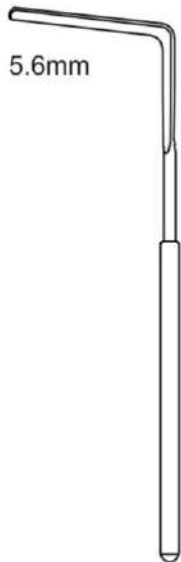

**RAGNELL**  
Retractor

▶ 42-4400 15.3cm

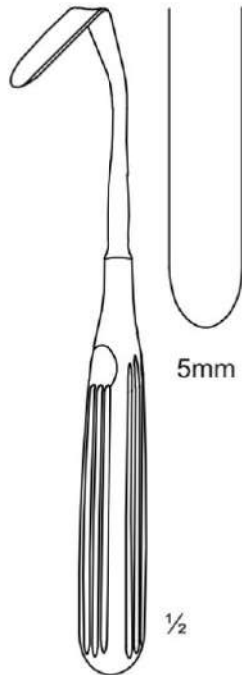

**AUFRICHT**  
Retractor

▶ 42-4500 18.0cm

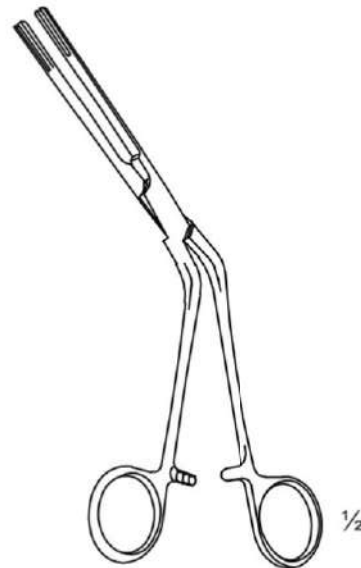

**JUNG'S Forceps**

▶ 42-4600 18.0cm

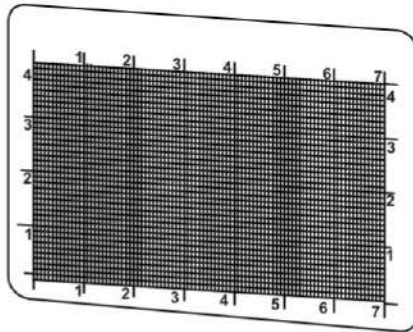

**GRID**

▶ 42-4700 57 x 83mm

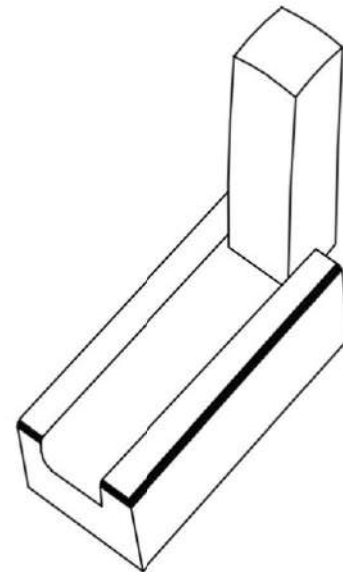

**CATIRAGE CRUSHER**

▶ 42-4800

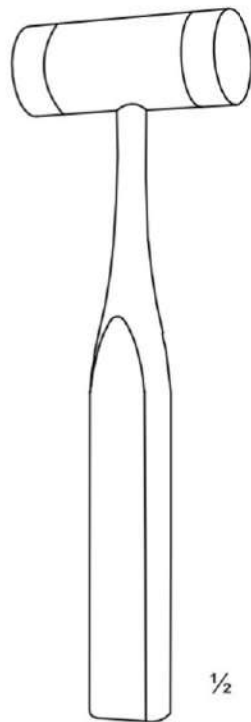

1/2

**MALLET**

with plastic disks

▶ 36-8630 ø25mm 140g

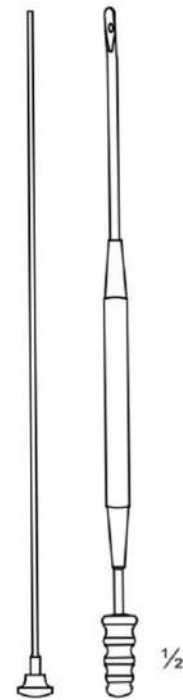

1/2

**GORNEY**

Suction Dissector

▶ 42-4900 18.0cm

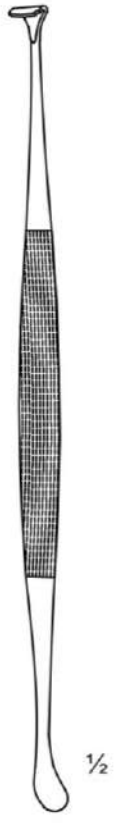

**HURD**  
▶ 43-0101 22.5cm



**KING-HURD**  
▶ 43-0102 17.0cm

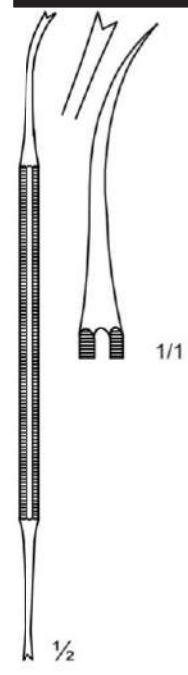

**LUNIATSCHEK**  
43-0200 19.0cm

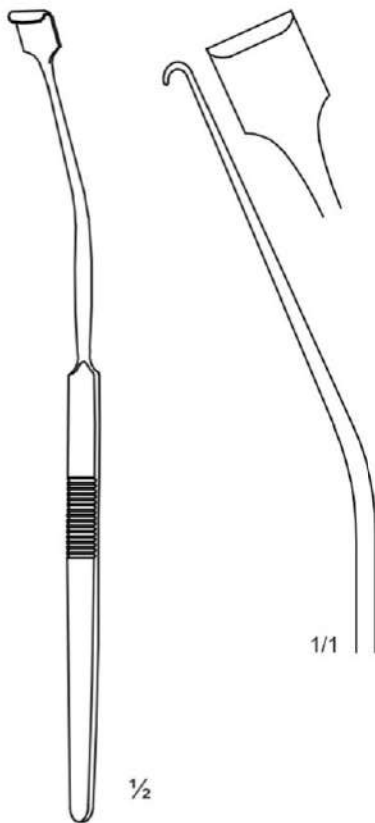

**NAGER**  
43-0400 24.0cm

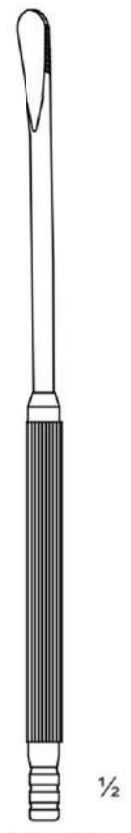

**LOPEZ-REINKE**  
Suction Dissector  
43-0500 23.5cm

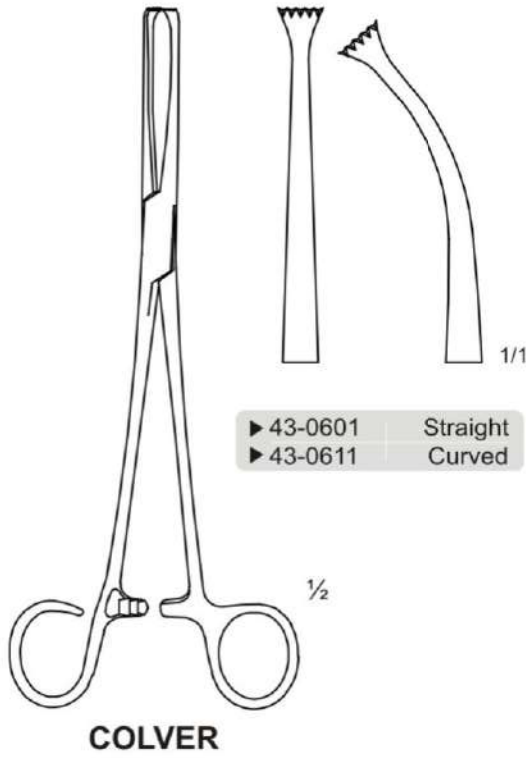

**COLVER**

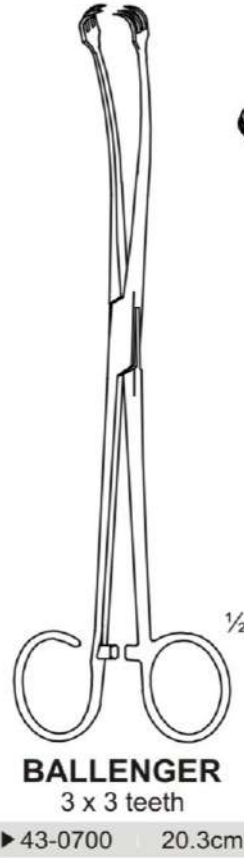

**BALLENGER**  
3 x 3 teeth

▶ 43-0700 20.3cm

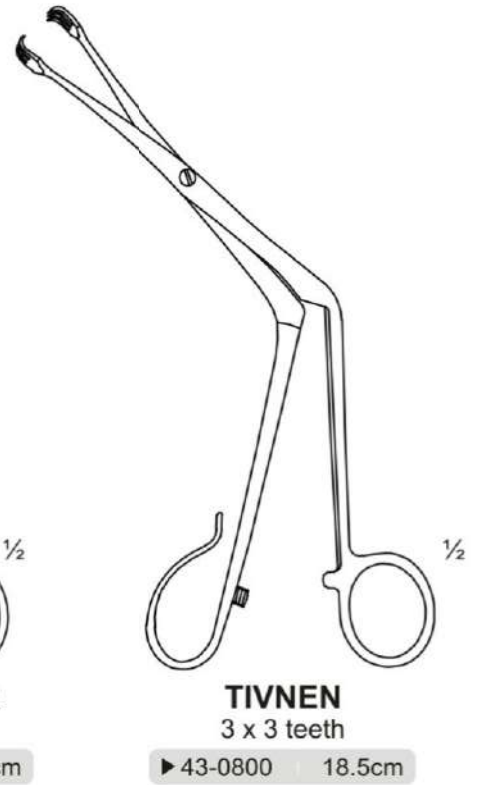

**TIVNEN**  
3 x 3 teeth

▶ 43-0800 18.5cm

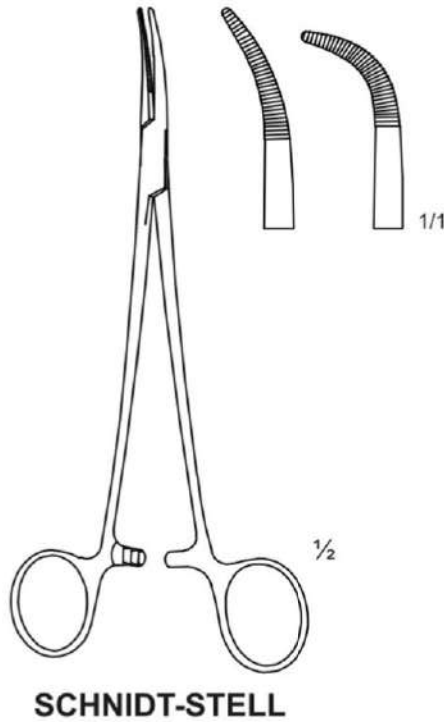

**SCHNIDT-STELL**

13-1911	19.0cm	Slightly Curved
13-1912	19.0cm	Full Curved

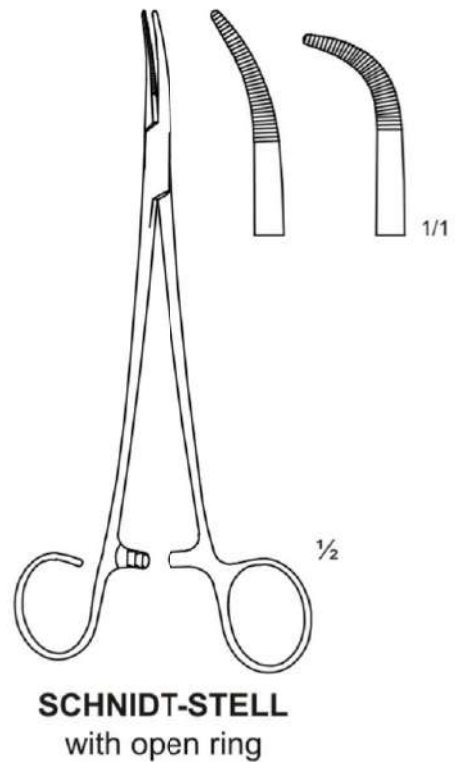

**SCHNIDT-STELL**  
with open ring

13-1921	19.0cm	Slightly Curved
13-1922	19.0cm	Full Curved



**Tonsil Seizing Forceps**

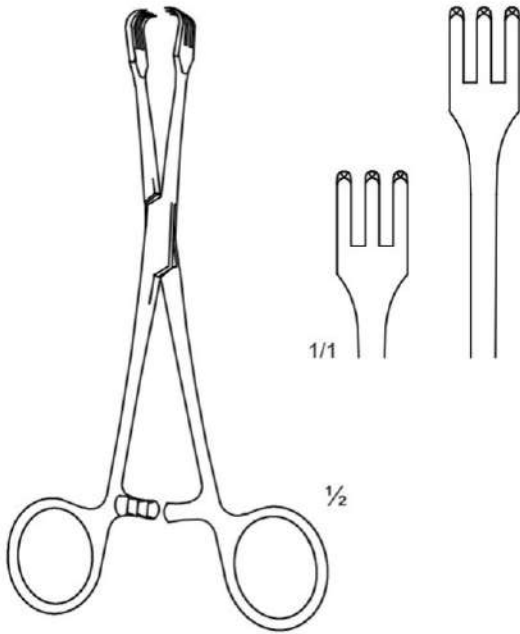

**LAHEY**

43-0810	15.0cm	3 x 3 teeth
43-0820	20.0cm	3 x 3 teeth

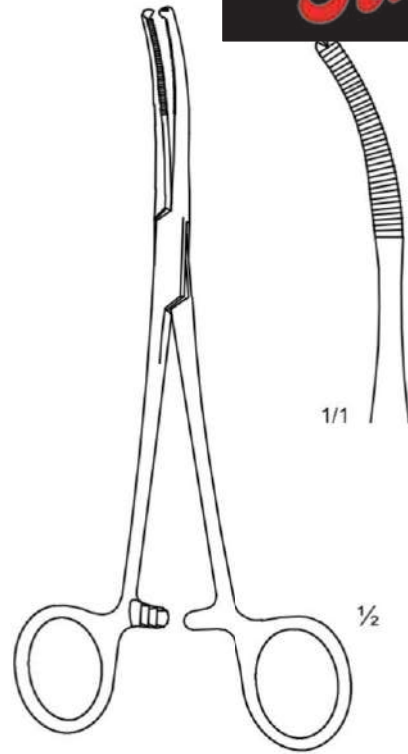

**MIKULICZ**

43-0830	18.0cm	1 x 2 teeth
---------	--------	-------------

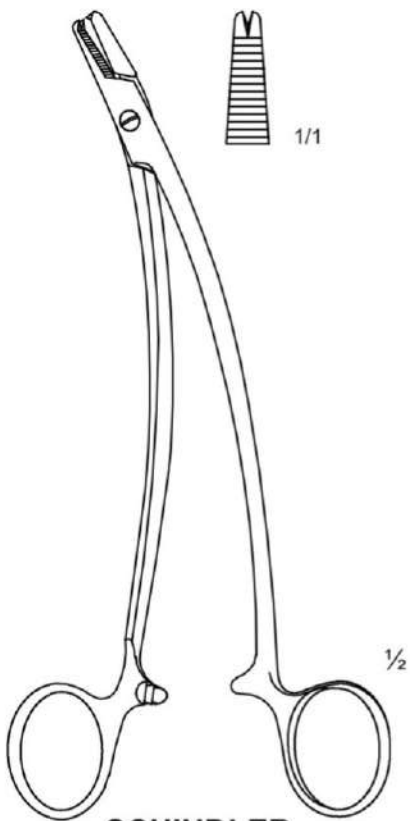

**SCHINDLER**

1 x 2 teeth

43-0840	19.0cm
---------	--------

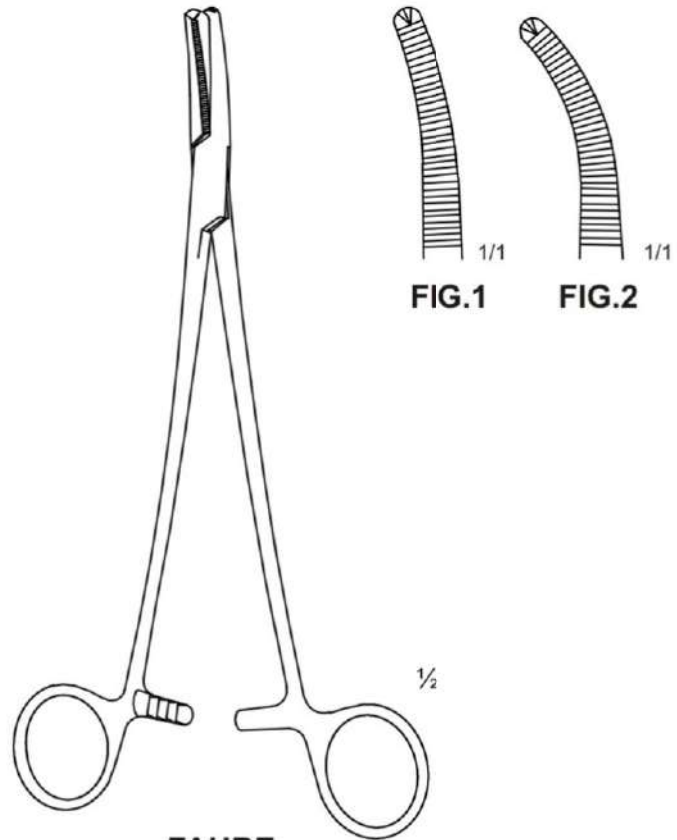

**FAURE**

1 x 2 teeth

43-0850	FIG.1
43-0860	FIG.2

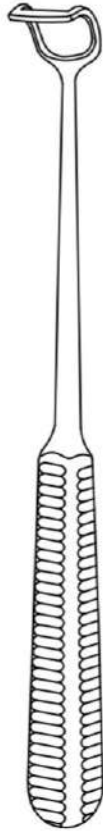

**BECKMANN**



1/1

43-0901	Straight
43-0911	Curved



1/1

43-0902	Straight
43-0912	Curved



1/1

43-0903	Straight
43-0913	Curved

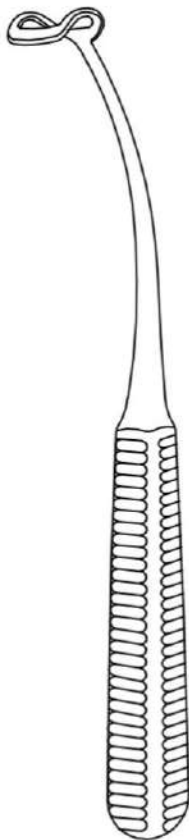

1/1

43-0904	Straight
43-0914	Curved



1/1

43-0905	Straight
43-0915	Curved



1/1

43-0906	Straight
43-0916	Curved



# Adenotomes & Tonsillectomes



**LA FORCE**  
Adenotomes

## Unperforated



13mm 1/1

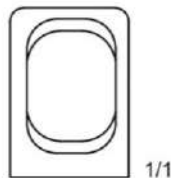

16mm 1/1

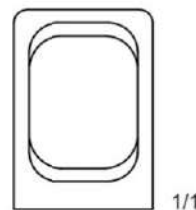

19mm 1/1

43-1001	13mm
43-1002	16mm
43-1003	19mm

43-1101	13mm	Spare Blade only
43-1102	16mm	Spare Blade only
43-1103	19mm	Spare Blade only

## Perforated

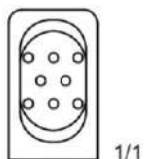

13mm 1/1

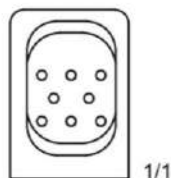

16mm 1/1

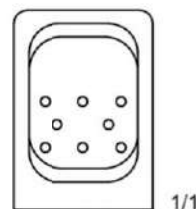

19mm 1/1

43-1010	13mm
43-1020	16mm
43-1030	19mm

43-1110	13mm	Spare Blade only
43-1120	16mm	Spare Blade only
43-1130	19mm	Spare Blade only

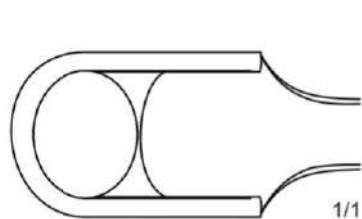

# 1

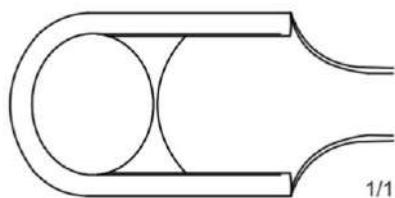

# 2

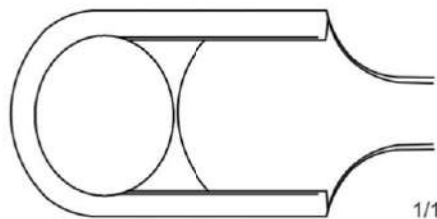

# 3

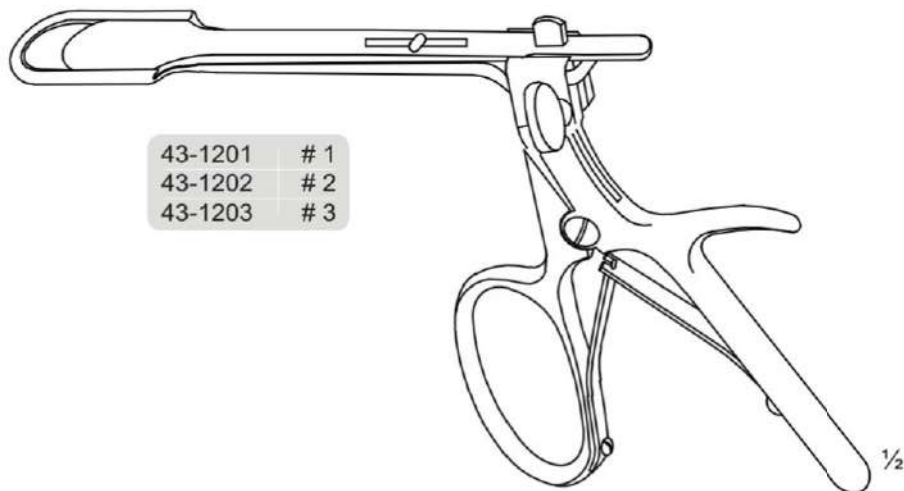

43-1201	# 1
43-1202	# 2
43-1203	# 3

**SLUDER-BALLENGER**  
Tonsillectomes

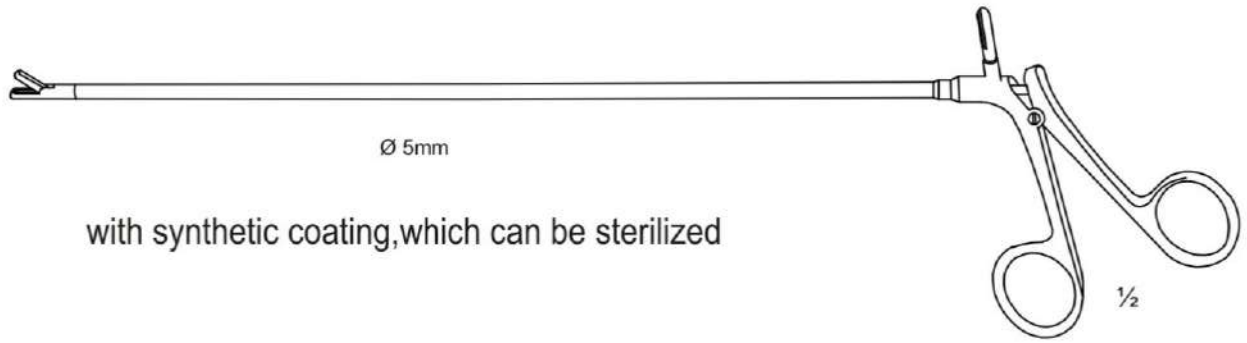

with synthetic coating, which can be sterilized

**ENDOSCOPY**

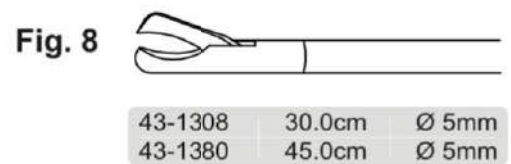
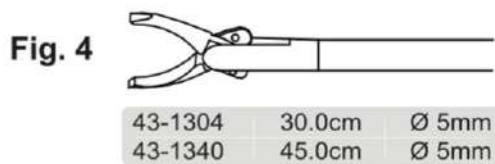
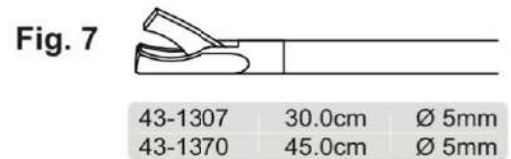
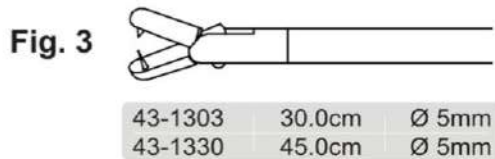
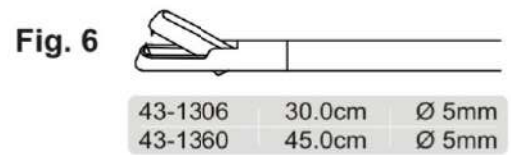
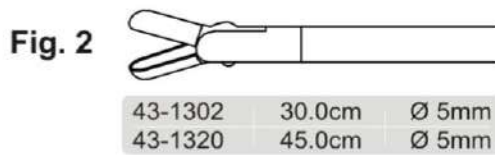
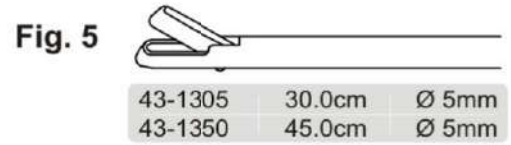
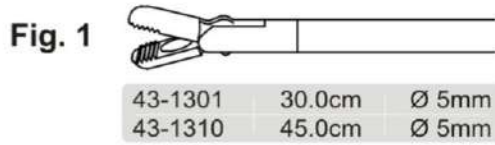



**HUBER**  
shank

43-1410	20.0cm
43-1420	30.0cm
43-1430	40.0cm

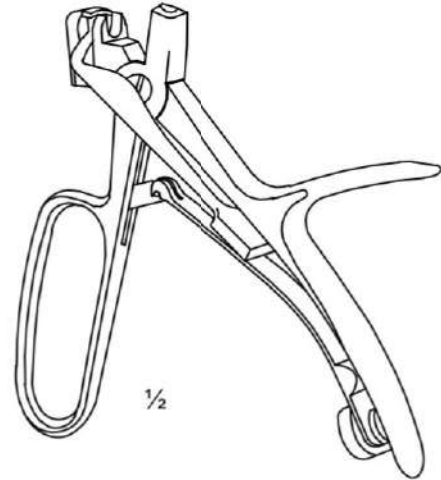

**HUBER**  
43-1400 Handle

Fig. 1



**KEVORKIAN**

43-1401

Fig. 2



**TISCHLER**

43-1402

Fig. 4

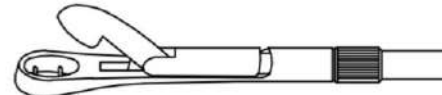

43-1404

Fig. 3

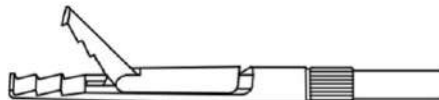

43-1403

Fig. 5

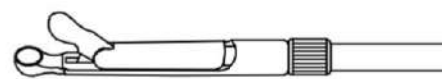

Ø 4mm

43-1405

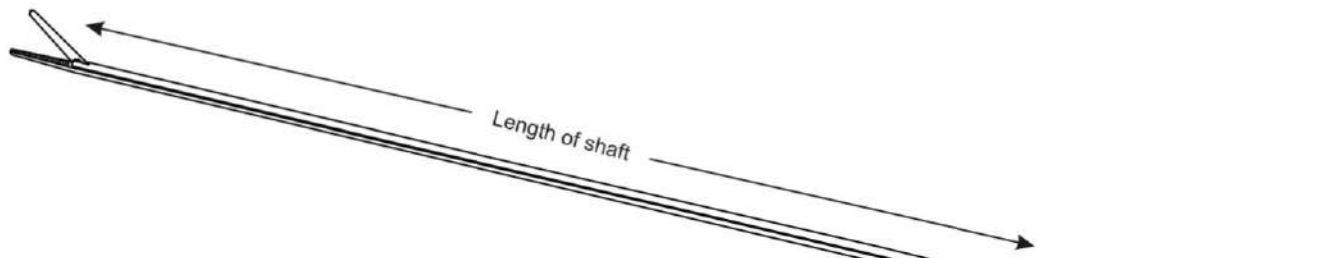

**Fig. 1**

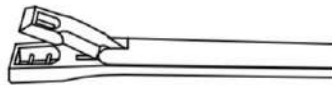

43-1501	30.0cm
43-1502	40.0cm
43-1503	50.0cm
43-1504	60.0cm

**Fig. 4**



Ø 2mm

43-1801	30.0cm
43-1802	40.0cm
43-1803	50.0cm
43-1804	60.0cm

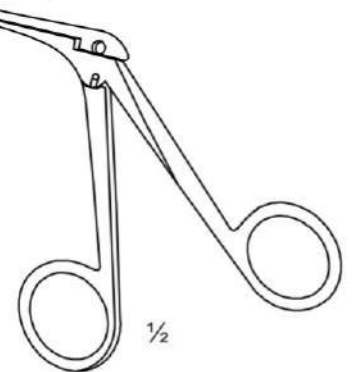

**CHEVALIER-JACKSON**

**Fig. 2**



43-1601	30.0cm
43-1602	40.0cm
43-1603	50.0cm
43-1604	60.0cm

Ø 4mm

43-1901	30.0cm
43-1902	40.0cm
43-1903	50.0cm
43-1904	60.0cm

Ø 6mm

43-2001	30.0cm
43-2002	40.0cm
43-2003	50.0cm
43-2004	60.0cm

**Fig. 7**

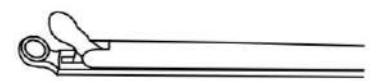

Ø 2mm

43-1811	30.0cm
43-1812	40.0cm
43-1813	50.0cm
43-1814	60.0cm

Ø 4mm

43-1911	30.0cm
43-1912	40.0cm
43-1913	50.0cm
43-1914	60.0cm

Ø 6mm

43-2011	30.0cm
43-2012	40.0cm
43-2013	50.0cm
43-2014	60.0cm

**Fig. 3**

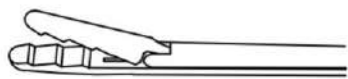

43-1701	30.0cm
43-1702	40.0cm
43-1703	50.0cm
43-1704	60.0cm

**Fig. 5**



43-2101	30.0cm
43-2102	40.0cm
43-2103	50.0cm
43-2104	60.0cm

**Fig. 6**

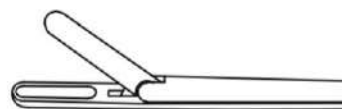

43-2201	30.0cm
43-2202	40.0cm
43-2203	50.0cm
43-2204	60.0cm

**Fig. 8**

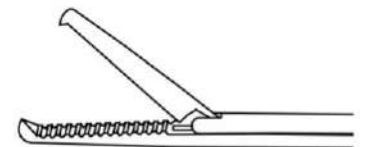

43-2301	30.0cm
43-2302	40.0cm
43-2303	50.0cm
43-2304	60.0cm

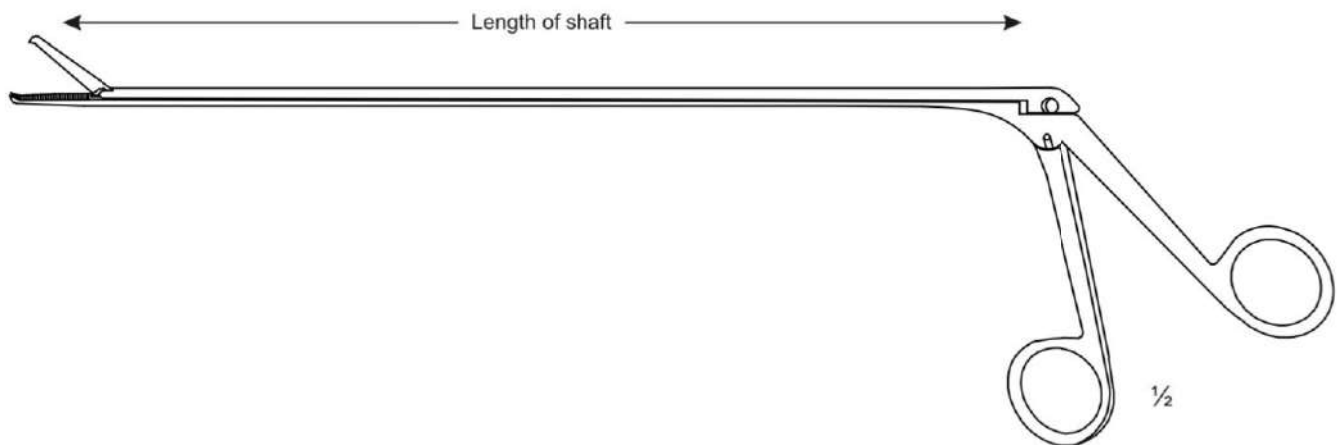

CHEVALIER-JACKSON

Fig. 9

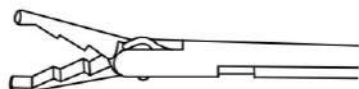

Double-Action

43-1721	30.0cm
43-1722	40.0cm
43-1723	50.0cm
43-1724	60.0cm

Fig. 10

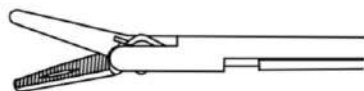

Double-Action

43-1621	30.0cm
43-1622	40.0cm
43-1623	50.0cm
43-1624	60.0cm

Fig. 11

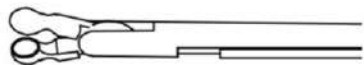

Double-Action

43-1821	30.0cm
43-1822	40.0cm
43-1823	50.0cm
43-1824	60.0cm



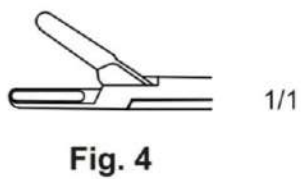
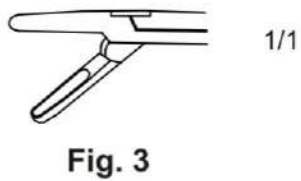
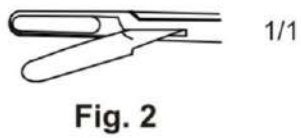
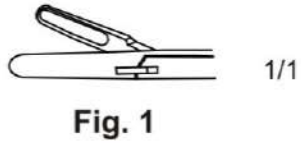

43-2401	FIG.1
43-2402	FIG.2
43-2403	FIG.3
43-2404	FIG.4



**LARYNGEAL**

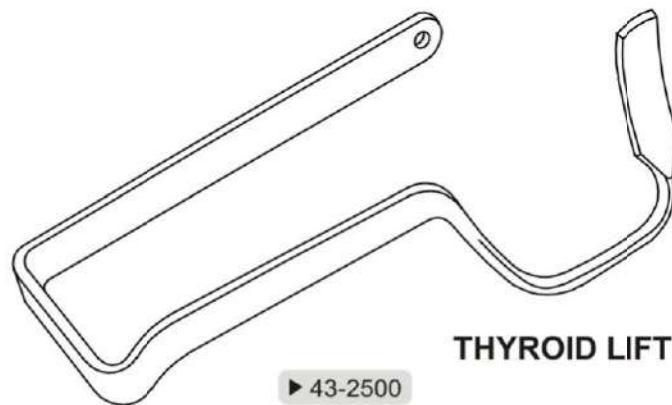

















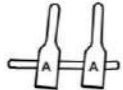

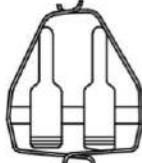

# **Atraumatic Instruments**

## Atraumatic Instruments

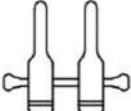

- *Atraumatic Instruments*
- *Vessel Clips*

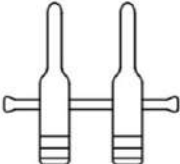

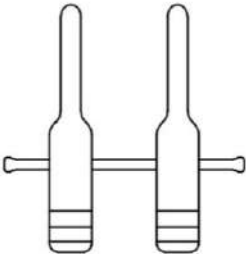
		Single clamp	Single clamp	Approximator	Approximator	Double clamp
 <b>8mm VESSEL</b> 0.4-1.0mm	Vein Artery	 44-0101 44-0111	 44-0121 44-0131	 44-0141 44-0151	 44-0161 44-0171	 44-0181 44-0191
 <b>11mm VESSEL</b> 0.6-1.5mm	Vein Artery	 44-0102 44-0112	 44-0122 44-0132	 44-0142 44-0152	 44-0162 44-0172	 44-0182 44-0192
 <b>17mm VESSEL</b> 1.0-2.25mm	Vein Artery	 44-0103 44-0113	 44-0123 44-0133	 44-0143 44-0153	 44-0163 44-0173	 44-0183 44-0193
 <b>25mm VESSEL</b> 1.5-3.5mm	Vein Artery		 44-0124 44-0134			 44-0184 44-0194
 <b>36mm VESSEL</b> 2.0-5.0mm	Vein Artery		 44-0125 44-0135			 44-0185 44-0195

Clamp Applying Forceps



44-0201	14.0cm	With Lock
44-0202	14.0cm	Without Lock

Complete Clips-Program Standard and Mini  
in TITANIUM  
in High Quality Implant-Steel, Anti-magnetic

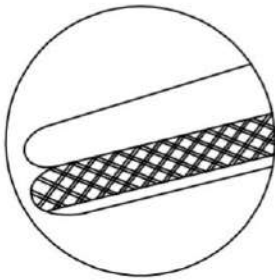

Rounded pyramid pattern

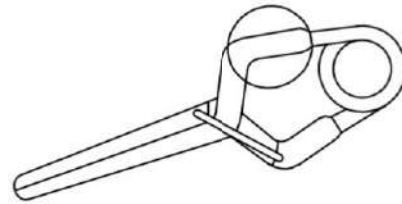

Each Clip With identification by serial number

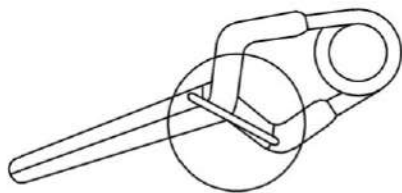



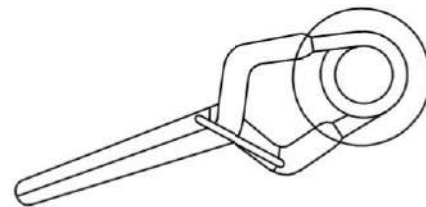

Leadership handle

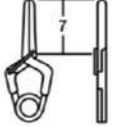
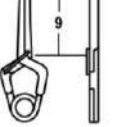
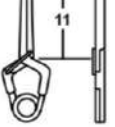
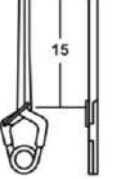
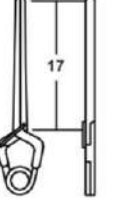
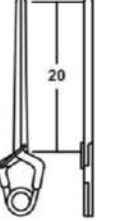
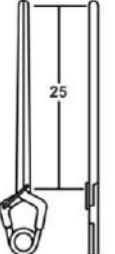

Spring

**STANDARD**

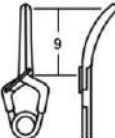
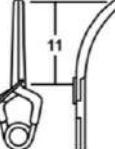
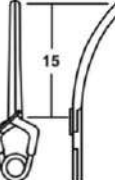
For Permanent Closure

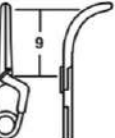
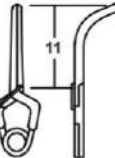
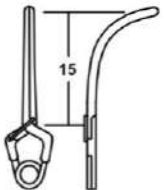
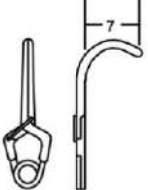
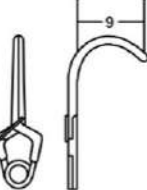
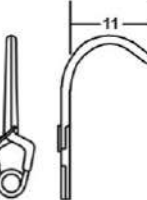
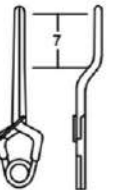
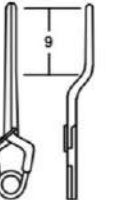
TITANIUM	44-0301 T	44-0302 T	44-0303 T	44-0304 T	44-0305 T	44-0306 T
Impl. steel	44-0301	44-0302	44-0303	44-0304	44-0305	44-0306
<b>FORM</b>						
	Max. opening	6.2 mm	7.0 mm	7.8 mm	9.2 mm	10.6 mm
Force	150 g	180 g	180 g	200 g	200 g	200 g
<b>44-0307 T</b>	<b>44-0311 T</b>	<b>44-0312 T</b>	<b>44-0313 T</b>	<b>44-0314 T</b>	<b>44-0321 T</b>	<b>44-0322 T</b>
<b>44-0307</b>	<b>44-0311</b>	<b>44-0312</b>	<b>44-0313</b>	<b>44-0314</b>	<b>44-0321</b>	<b>44-0322</b>
						
13.3 mm	6.0 mm	6.8 mm	7.5 mm	8.7 mm	5.5 mm	6.1 mm
200 g	150 g	180 g	180 g	200 g	150 g	180 g
<b>44-0323 T</b>	<b>44-0324 T</b>	<b>44-0331 T</b>	<b>44-0332 T</b>	<b>44-0333 T</b>	<b>44-0341 T</b>	<b>44-0342 T</b>
<b>44-0323</b>	<b>44-0324</b>	<b>44-0331</b>	<b>44-0332</b>	<b>44-0333</b>	<b>44-0341</b>	<b>44-0342</b>
						
6.5 mm	7.4 mm	5.4 mm	5.8 mm	6.2 mm	7.9 mm	8.7 mm
180 g	200 g	180 g	180 g	180 g	200 g	200 g



**STANDARD**

For Permanent Closure

TITANIUM	44-0343 T	44-0344 T	44-0345 T	44-0351 T	44-0352 T	44-0353 T
Impl. steel	44-0343	44-0344	44-0345	44-0351	44-0352	44-0353
<b>FORM</b>						
Max. opening	10.2 mm	11.9 mm	13.0 mm	6.2 mm	6.5 mm	7.8 mm
Force	200 g	180 g	180 g	200 g	200 g	200 g
<b>44-0354 T</b>	<b>44-0361 T</b>	<b>44-0362 T</b>	<b>44-0363 T</b>	<b>44-0364 T</b>	<b>44-0365 T</b>	<b>44-0371 T</b>
<b>44-0354</b>	<b>44-0361</b>	<b>44-0362</b>	<b>44-0363</b>	<b>44-0364</b>	<b>44-0365</b>	<b>44-0371</b>
8.4 mm	5.6 mm	5.6 mm	5.6 mm	5.4 mm	5.6 mm	7.2 mm
200 g	200 g	200 g	200 g	200 g	200 g	200 g
<b>44-0372 T</b>	<b>44-0373 T</b>	<b>44-0381 T</b>	<b>44-0382 T</b>	<b>44-0383 T</b>		
<b>44-0372</b>	<b>44-0373</b>	<b>44-0381</b>	<b>44-0382</b>	<b>44-0383</b>		
7.2 mm	8.2 mm	5.7 mm	8.0 mm	7.0 mm		
200 g	200 g	200 g	200 g	200 g		

**STANDARD**

For Permanent Closure, Fenestrated 3.5mm

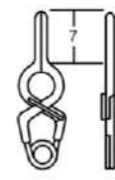
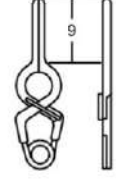
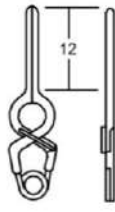
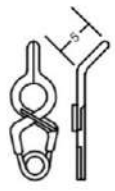
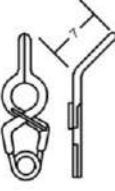
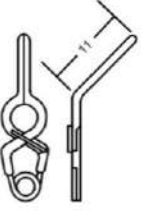
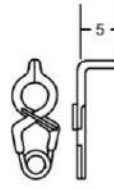
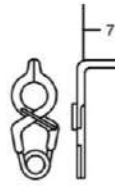
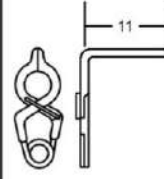
TITANIUM	44-0401 T	44-0402 T	44-0403 T	44-0411 T	44-0412 T	44-0413 T
Impl. steel	44-0401	44-0402	44-0403	44-0411	44-0412	44-0413
<b>FORM</b>						
Max. opening	7.4 mm	8.4 mm	9.6 mm	5.8 mm	6.5 mm	7.2 mm
Force	150 g	150 g	180 g	150 g	150 g	180 g
	44-0421 T	44-0422 T	44-0423 T			
	44-0421	44-0422	44-0423			
						
	4.9 mm	4.9 mm	4.9 mm			
	150 g	150 g	180 g			

Atraumatic Instruments















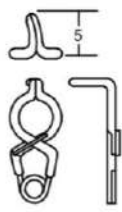
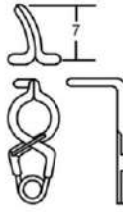
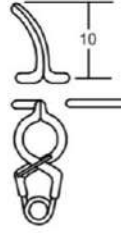

**STANDARD**

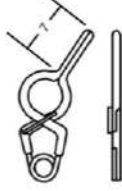
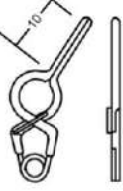
For Permanent Closure, Fenestrated 5.0mm

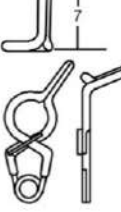
TITANIUM	<b>44-0501 T</b>	<b>44-0502 T</b>	<b>44-0503 T</b>	<b>44-0511 T</b>	<b>44-0512 T</b>	<b>44-0513 T</b>
Impl. steel	<b>44-0501</b>	<b>44-0502</b>	<b>44-0503</b>	<b>44-0511</b>	<b>44-0512</b>	<b>44-0513</b>
<b>FORM</b>						
Max. opening	7.9 mm	9.1 mm	10.3 mm	6.5 mm	7.2 mm	7.8 mm
Force	150 g	150 g	180 g	150 g	150 g	180 g
<b>44-0521 T</b>	<b>44-0522 T</b>	<b>44-0523 T</b>	<b>44-0531 T</b>	<b>44-0532 T</b>	<b>44-0533 T</b>	
<b>44-0521</b>	<b>44-0522</b>	<b>44-0523</b>	<b>44-0531</b>	<b>44-0532</b>	<b>44-0533</b>	
5.5 mm	5.5 mm	5.5 mm	7.9 mm	8.8 mm	10.0 mm	
150 g	150 g	180 g	150 g	150 g	180 g	

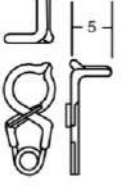
**STANDARD**

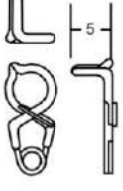
For Permanent Closure, Fenestrated 5.0mm

TITANIUM	44-0541 T	44-0542 T	44-0543 T	44-0544 T	44-0545 T	44-0546 T
Impl. steel	44-0541	44-0542	44-0543	44-0544	44-0545	44-0546
<b>FORM</b>						
Max. opening	5.8 mm	5.8 mm	5.8 mm	5.8 mm	5.8 mm	5.8 mm
Force	150 g	150 g	150 g	150 g	150 g	150 g
<b>44-0551 T</b>	<b>44-0552 T</b>	<b>44-0553 T</b>	<b>44-0561 T</b>	<b>44-0562 T</b>	<b>44-0563 T</b>	<b>44-0564 T</b>
<b>44-0551</b>	<b>44-0552</b>	<b>44-0553</b>	<b>44-0561</b>	<b>44-0562</b>	<b>44-0563</b>	<b>44-0564</b>
						
7.0 mm	7.8 mm	8.8 mm	5.8 mm	6.2 mm	5.8 mm	6.2 mm
150 g	150 g	150 g	150 g	150 g	150 g	150 g
<b>44-0571 T</b>	<b>44-0572 T</b>	<b>44-0573 T</b>	<b>44-0574 T</b>			
<b>44-0571</b>	<b>44-0572</b>	<b>44-0573</b>	<b>44-0574</b>			
						
5.6 mm	5.6 mm	5.6 mm	5.6 mm			
150 g	150 g	150 g	150 g			





**MINI**

For Permanent Closure

TITANIUM	44-0601 T	44-0602 T	44-0611 T	44-0612 T	44-0613 T	44-0621 T
Impl. steel	44-0601	44-0602	44-0611	44-0612	44-0613	44-0621
<b>FORM</b>						
Max. opening	3.3 mm	4.0 mm	3.3 mm	4.0 mm	4.6 mm	3.2 mm
Force	110 g	110 g	110 g	110 g	110 g	110 g
<b>44-0622 T</b>	<b>44-0631 T</b>	<b>44-0632 T</b>	<b>44-0641 T</b>	<b>44-0642 T</b>	<b>44-0643 T</b>	<b>44-0623 T</b>
<b>44-0622</b>	<b>44-0631</b>	<b>44-0632</b>	<b>44-0641</b>	<b>44-0642</b>	<b>44-0643</b>	<b>44-0623</b>
3.8 mm	3.6 mm	3.8 mm	3.6 mm	4.0 mm	4.4 mm	3.6 mm
110 g	110 g	110 g	110 g	110 g	110 g	110 g
<b>44-0651 T</b>	<b>44-0652 T</b>	<b>44-0661 T</b>	<b>44-0671 T</b>	<b>44-0681 T</b>	<b>44-0682 T</b>	<b>44-0691 T</b>
<b>44-0651</b>	<b>44-0652</b>	<b>44-0661</b>	<b>44-0671</b>	<b>44-0681</b>	<b>44-0682</b>	<b>44-0691</b>
3.5 mm	4.0 mm	3.5 mm	6.0 mm	7.0 mm	5.7 mm	4.5 mm
110 g	110 g	130 g	130 g	130 g	130 g	130 g

**STANDARD**

For Temporary Closure

TITANIUM	44-0701 T	44-0702 T	44-0703 T	44-0704 T	44-0705 T	44-0706 T
Impl. steel	44-0701	44-0702	44-0703	44-0704	44-0705	44-0706
<b>FORM</b>						
Max. opening	6.2 mm	7.0 mm	7.8 mm	9.2 mm	10.6 mm	11.4 mm
Force	110 g	90 g	90 g	90 g	90 g	110 g
<b>44-0707 T</b>	<b>44-0711 T</b>	<b>44-0712 T</b>	<b>44-0713 T</b>	<b>44-0714 T</b>	<b>44-0721 T</b>	<b>44-0722 T</b>
<b>44-0707</b>	<b>44-0711</b>	<b>44-0712</b>	<b>44-0713</b>	<b>44-0714</b>	<b>44-0721</b>	<b>44-0722</b>
13.3 mm	6.0 mm	6.8 mm	7.5 mm	8.7 mm	5.5 mm	6.1 mm
110 g	110 g	90 g	90 g	110 g	110 g	110 g
<b>44-0723 T</b>	<b>44-0724 T</b>	<b>44-0731 T</b>	<b>44-0732 T</b>	<b>44-0733 T</b>	<b>44-0741 T</b>	<b>44-0742 T</b>
<b>44-0723</b>	<b>44-0724</b>	<b>44-0731</b>	<b>44-0732</b>	<b>44-0733</b>	<b>44-0741</b>	<b>44-0742</b>
6.5 mm	7.4 mm	5.4 mm	5.8 mm	6.2 mm	7.9 mm	8.7 mm
110 g	110 g	110 g	110 g	110 g	90 g	90 g







**STANDARD**

For Temporary Closure

TITANIUM	44-0743 T	44-0744 T	44-0745 T	44-0751 T	44-0752 T	44-0753 T
Impl. steel	44-0743	44-0744	44-0745	44-0751	44-0752	44-0753
<b>FORM</b>						
Max. opening	10.2 mm	11.9 mm	13.0 mm	6.2 mm	6.5 mm	7.8 mm
Force	90 g	90 g	90 g	110 g	110 g	110 g
<b>44-0754 T</b>	<b>44-0761 T</b>	<b>44-0762 T</b>	<b>44-0763 T</b>	<b>44-0764 T</b>	<b>44-0765 T</b>	<b>44-0771 T</b>
<b>44-0754</b>	<b>44-0761</b>	<b>44-0762</b>	<b>44-0763</b>	<b>44-0764</b>	<b>44-0765</b>	<b>44-0771</b>
8.4 mm	5.6 mm	5.6 mm	5.6 mm	5.4 mm	5.6 mm	7.2 mm
110 g	130 g	130 g	130 g	130 g	130 g	90 g
<b>44-0772 T</b>	<b>44-0773 T</b>	<b>44-0781 T</b>	<b>44-0782 T</b>	<b>44-0783 T</b>		
<b>44-0772</b>	<b>44-0773</b>	<b>44-0781</b>	<b>44-0782</b>	<b>44-0783</b>		
7.2 mm	8.2 mm	5.7 mm	8.0 mm	7.0 mm		
90 g	90 g	90 g	90 g	90 g		

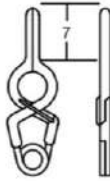
**STANDARD**

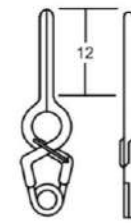
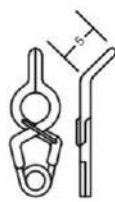
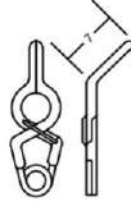
For Temporary Closure, Fenestrated 3.5mm

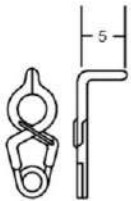
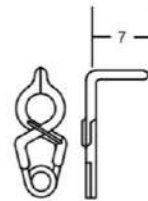
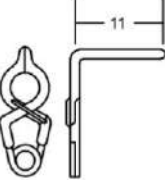
TITANIUM	<b>44-0801 T</b>	<b>44-0802 T</b>	<b>44-0803 T</b>	<b>44-0811 T</b>	<b>44-0812 T</b>	<b>44-0813 T</b>
Impl. steel	<b>44-0801</b>	<b>44-0802</b>	<b>44-0803</b>	<b>44-0811</b>	<b>44-0812</b>	<b>44-0813</b>
<b>FORM</b>						
Max. opening	7.4 mm	8.4 mm	9.6 mm	5.8 mm	6.5 mm	7.2 mm
Force	110 g	110 g	90 g	110 g	110 g	110 g
<b>44-0821 T</b>	<b>44-0822 T</b>	<b>44-0823 T</b>				
<b>44-0821</b>	<b>44-0822</b>	<b>44-0823</b>				
						
4.9 mm	4.9 mm	4.9 mm				
110 g	110 g	110 g				

Atraumatic Instruments















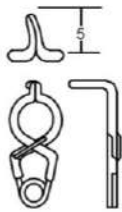
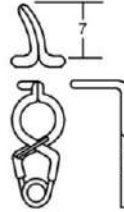

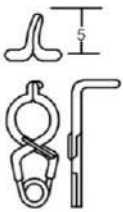
**STANDARD**

For Temporary Closure, Fenestrated 5.0mm

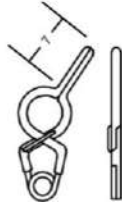
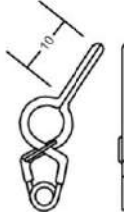
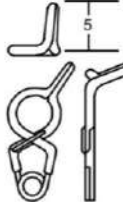
TITANIUM	44-0901 T	44-0902 T	44-0903 T	44-0911 T	44-0912 T	44-0913 T
Impl. steel	44-0901	44-0902	44-0903	44-0911	44-0912	44-0913
<b>FORM</b>						
Max. opening	7.9 mm	9.1 mm	10.3 mm	6.5 mm	7.2 mm	7.8 mm
Force	110 g	100 g	90 g	110 g	110 g	110 g
	44-0921 T	44-0922 T	44-0923 T	44-0931 T	44-0932 T	44-0933 T
	44-0921	44-0922	44-0923	44-0931	44-0932	44-0933
	5.5 mm	5.5 mm	5.5 mm	7.9 mm	8.8 mm	10.0 mm
	110 g	110 g	90 g	90 g	90 g	

**STANDARD**

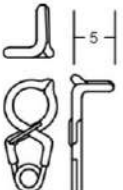
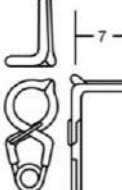
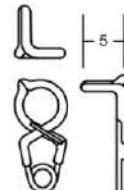
For Temporary Closure, Fenestrated 5.0mm

TITANIUM	44-0941 T	44-0942 T	44-0943 T	44-0944 T	44-0945 T	44-0946 T
Impl. steel	44-0941	44-0942	44-0943	44-0944	44-0945	44-0946
<b>FORM</b>						
Max. opening	5.8 mm	5.8 mm	5.8 mm	5.8 mm	5.8 mm	5.8 mm
Force	110 g	110 g	110 g	110 g	110 g	110 g
<b>44-0951 T</b>	<b>44-0952 T</b>	<b>44-0953 T</b>	<b>44-0961 T</b>	<b>44-0962 T</b>	<b>44-0963 T</b>	<b>44-0964 T</b>
<b>44-0951</b>	<b>44-0952</b>	<b>44-0953</b>	<b>44-0961</b>	<b>44-0962</b>	<b>44-0963</b>	<b>44-0964</b>
						
7.0 mm	7.8 mm	8.8 mm	5.8 mm	6.2 mm	5.8 mm	6.2 mm
110 g	110 g	110 g	110 g	110 g	110 g	110 g
<b>44-0971 T</b>	<b>44-0972 T</b>	<b>44-0973 T</b>	<b>44-0974 T</b>			
<b>44-0971</b>	<b>44-0972</b>	<b>44-0973</b>	<b>44-0974</b>			
						
5.6 mm	5.6 mm	5.6 mm	5.6 mm			
110 g	110 g	110 g	110 g			



**MINI**

For Temporary Closure

TITANIUM	44-1001 T	44-1002 T	44-1011 T	44-1012 T	44-1013 T	44-1021 T
Impl. steel	44-1001	44-1002	44-1011	44-1012	44-1013	44-1021
<b>FORM</b>						
Max. opening	3.3 mm	4.0 mm	3.3 mm	4.0 mm	4.6 mm	3.2 mm
Force	90 g	70 g	90 g	70 g	70 g	90 g
<b>44-1022 T</b>	<b>44-1031 T</b>	<b>44-1032 T</b>	<b>44-1041 T</b>	<b>44-1042 T</b>	<b>44-1043 T</b>	<b>44-1023 T</b>
<b>44-1022</b>	<b>44-1031</b>	<b>44-1032</b>	<b>44-1041</b>	<b>44-1042</b>	<b>44-1043</b>	<b>44-1023</b>
3.8 mm	3.6 mm	3.8 mm	3.6 mm	4.0 mm	4.4 mm	3.6 mm
70 g	80 g	70 g	80 g	70 g	70 g	80 g
<b>44-1051 T</b>	<b>44-1052 T</b>	<b>44-1061 T</b>	<b>44-1071 T</b>	<b>44-1081 T</b>	<b>44-1082 T</b>	<b>44-1091 T</b>
<b>44-1051</b>	<b>44-1052</b>	<b>44-1061</b>	<b>44-1071</b>	<b>44-1081</b>	<b>44-1082</b>	<b>44-1091</b>
3.5 mm	4.0 mm	3.5 mm	6.0 mm	7.0 mm	5.7 mm	4.5 mm
80 g	70 g	70 g	70 g	70 g	70 g	70 g



## STANDARD

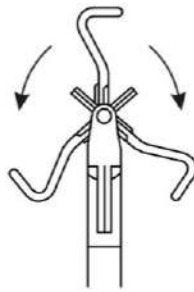
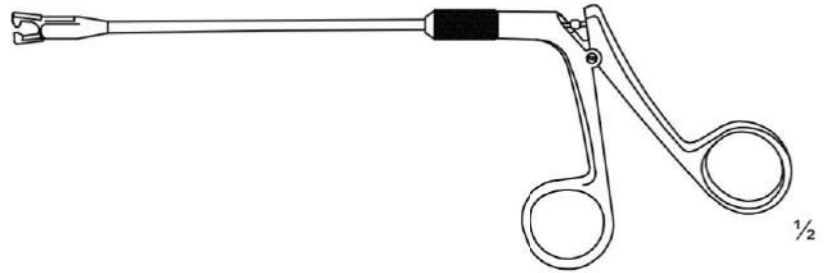

**Mouth Rotating**



### Length of Shaft

44-1101	7.0cm
44-1102	9.0cm
44-1103	11.0cm
44-1104	13.0cm



**Mouth Rotating**

44-1101T	7.0cm
44-1102T	9.0cm
44-1103T	11.0cm
44-1104T	13.0cm

TITANIUM



**Mouth Fixed**

44-1111	7.0cm
44-1112	9.0cm
44-1113	11.0cm
44-1114	13.0cm

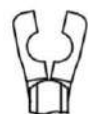

**Mouth Fixed**

44-1111T	7.0cm
44-1112T	9.0cm
44-1113T	11.0cm
44-1114T	13.0cm

TITANIUM



**MINI**

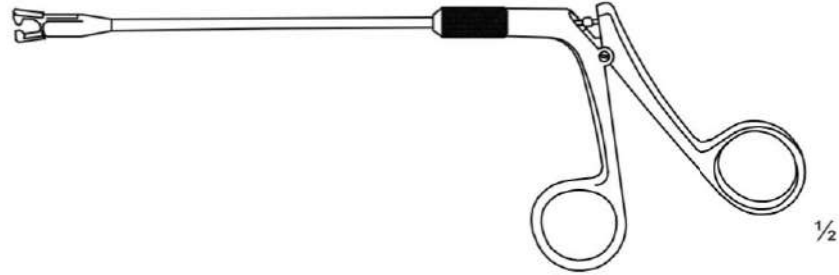

Length of Shaft

44-1121	7.0cm
44-1122	9.0cm
44-1123	11.0cm
44-1124	13.0cm

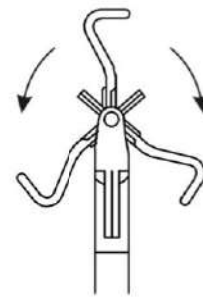

44-1121T	7.0cm
44-1122T	9.0cm
44-1123T	11.0cm
44-1124T	13.0cm

TITANIUM



44-1131	7.0cm
44-1132	9.0cm
44-1133	11.0cm
44-1134	13.0cm



44-1131T	7.0cm
44-1132T	9.0cm
44-1133T	11.0cm
44-1134T	13.0cm

TITANIUM



## STANDARD

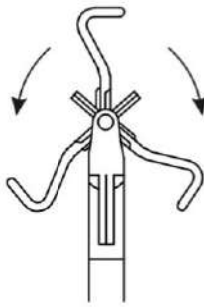
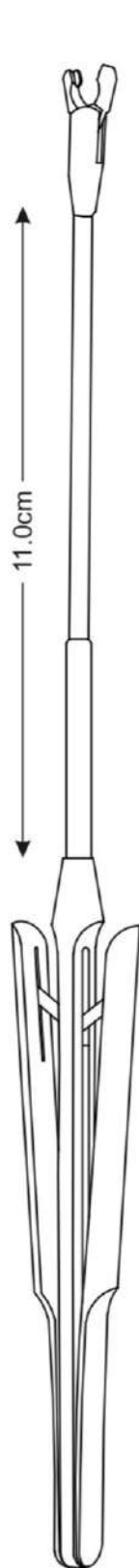

**Mouth Rotating**



**Mouth Rotating**



**Mouth Fixed**



**Mouth Fixed**



Length of Shaft

44-1201	7.0cm
44-1202	9.0cm
44-1203	11.0cm

44-1201T	7.0cm
44-1202T	9.0cm
44-1203T	11.0cm

TITANIUM

44-1211	7.0cm
44-1212	9.0cm
44-1213	11.0cm

44-1211T	7.0cm
44-1212T	9.0cm
44-1213T	11.0cm

TITANIUM



**MINI**

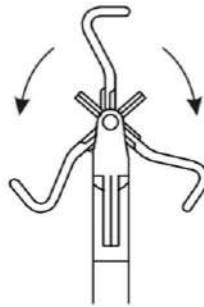

Length of Shaft

44-1221	7.0cm
44-1222	9.0cm
44-1223	11.0cm

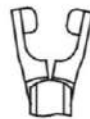

**Mouth Rotating**



**Mouth Rotating**

44-1221T	7.0cm
44-1222T	9.0cm
44-1223T	11.0cm

**TITANIUM**



**Mouth Fixed**

44-1231	7.0cm
44-1232	9.0cm
44-1233	11.0cm



**Mouth Fixed**

44-1231T	7.0cm
44-1232T	9.0cm
44-1233T	11.0cm

**TITANIUM**

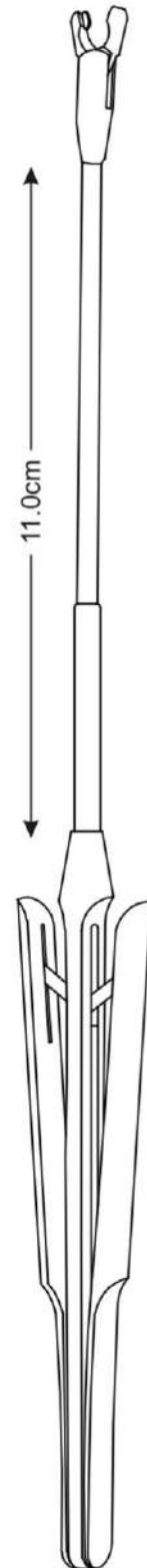

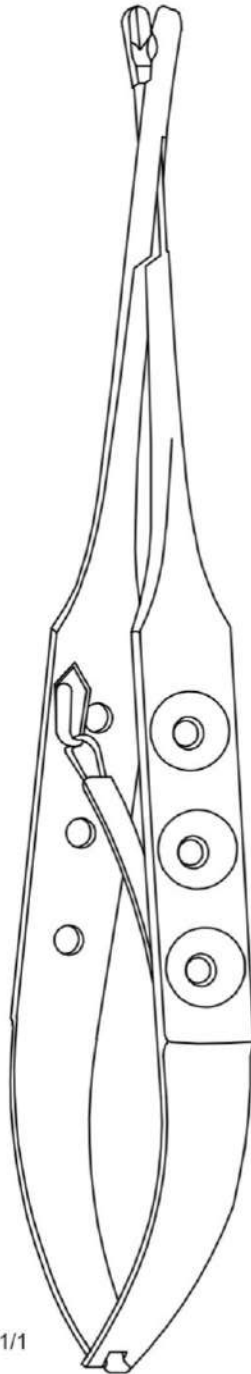

**Mouth Fixed**

**STANDARD**

Total Length	
44-1301	18.0cm
44-1301T	18.0cm

TITANIUM



**Mouth Rotating**

**STANDARD**

44-1311	18.0cm
44-1311T	18.0cm

TITANIUM



**Mouth Fixed**

**MINI**

44-1321	18.0cm
44-1321T	18.0cm

TITANIUM



**Mouth Rotating**

**MINI**

44-1331	18.0cm
44-1331T	18.0cm

TITANIUM

# Applying Forceps For Yasargil Aneurysm-Clips



Total Length

44-1401	17.0cm
44-1402	21.0cm
44-1403	23.0cm

44-1401T	17.0cm
44-1402T	21.0cm
44-1403T	23.0cm

TITANIUM

**STANDARD**



**Mouth Fixed**

44-1411	17.0cm
44-1412	21.0cm
44-1413	23.0cm

44-1411T	17.0cm
44-1412T	21.0cm
44-1413T	23.0cm

TITANIUM

**STANDARD**



**Mouth Rotating**

44-1421	17.0cm
44-1422	21.0cm
44-1423	23.0cm

44-1421T	17.0cm
44-1422T	21.0cm
44-1423T	23.0cm

TITANIUM

**MINI**



**Mouth Fixed**

44-1431	17.0cm
44-1432	21.0cm
44-1433	23.0cm

44-1431T	17.0cm
44-1432T	21.0cm
44-1433T	23.0cm

TITANIUM

**MINI**



**Mouth Rotating**

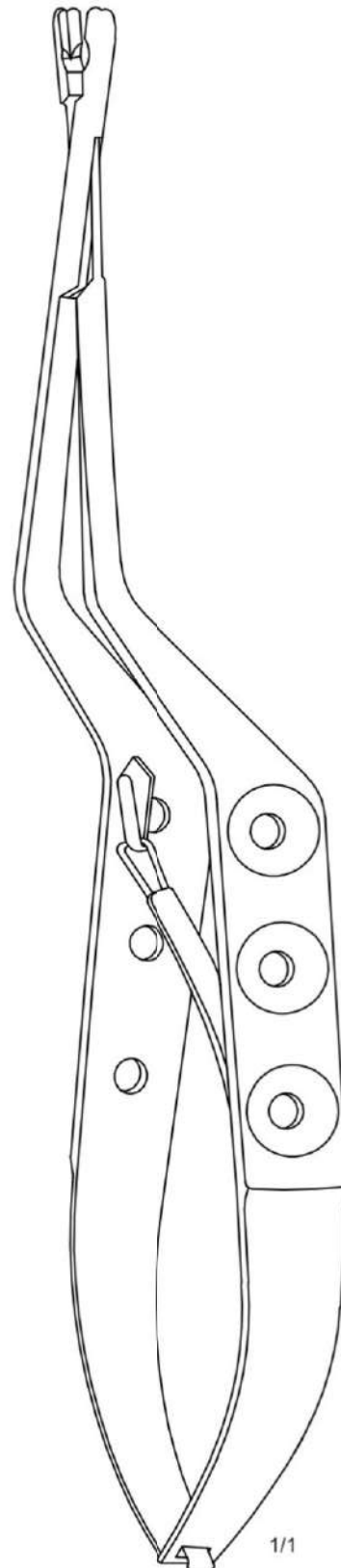

1/1

Atraumatic Instruments





2/1

**BIEMER**



Cat No.	Opening	Length of Jaws	Closing force
44-1501	4.0 mm	6.0 mm	30-40 g

44-1502	5.0 mm	9.0 mm	30-40 g
---------	--------	--------	---------

44-1503	5.0 mm	9.0 mm	20-25 g
---------	--------	--------	---------



2/1

**MEHDORN**

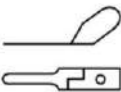
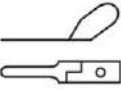
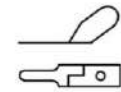
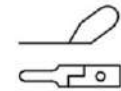

Cat No.	Jaws	Closing force
44-1601	4 x 1.0 mm	10 - 15 g

44-1602	4 x 1.4 mm	15 - 20 g
---------	------------	-----------

44-1603	6 x 1.0 mm	10 - 15 g
---------	------------	-----------

44-1604	6 x 1.4 mm	15 - 20 g
---------	------------	-----------



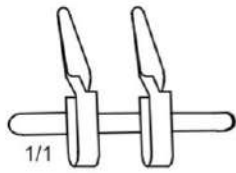

**BIEMER-MULLER**

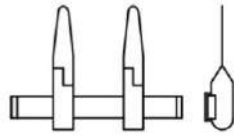

Cat No.	Opening	Length of Jaws	Closing force
44-1701	5.0 mm	9.0 mm	25-30 g

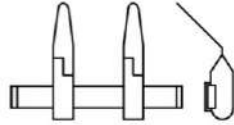

44-1711	5.0 mm	9.0 mm	25-30 g
---------	--------	--------	---------

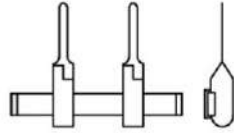

44-1702	5.0 mm	9.0 mm	25-30 g
---------	--------	--------	---------

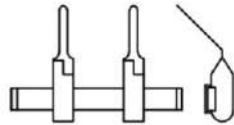

44-1712	5.0 mm	9.0 mm	25-30 g
---------	--------	--------	---------

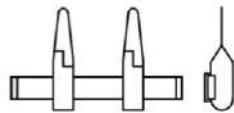

44-1703	3.0 mm	4.5 mm	25-30 g
---------	--------	--------	---------

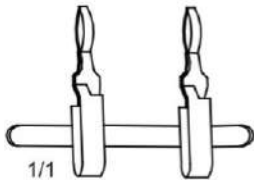

**MULLER**

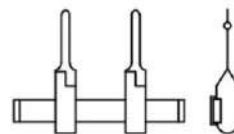

44-1801	Ø 1.0 mm	25-30 g
---------	----------	---------

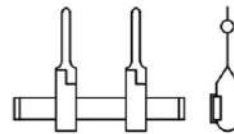

44-1802	Ø 2.0 mm	25-30 g
---------	----------	---------

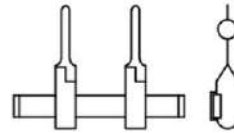

44-1803	Ø 3.0 mm	25-30 g
---------	----------	---------

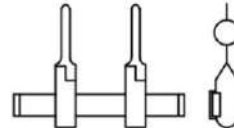

44-1804	Ø 4.0 mm	25-30 g
---------	----------	---------

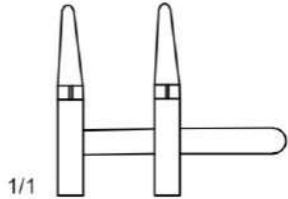

**BIEMER**

44-1900 Approximator With Applying Forceps 044-2302  
44-1901 Approximator Only

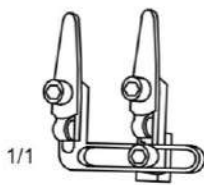

**BIEMER**



**KEY**

44-2001

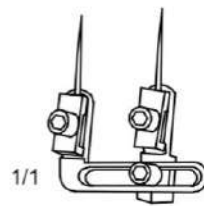

**BIEMER**



**KEY**

44-2001

44-2000 Approximator With Key 044-2001

44-2100 Approximator With Key 044-2001  
44-2101 1 Pair of Spare Needles

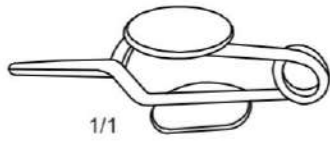

**MULLER**  
38mm  
Atraumatic Vessel Clips

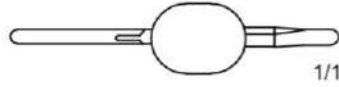

Closing Force	
44-2201	50g
44-2211	80g

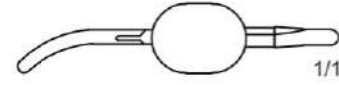

44-2202	50g
44-2212	80g

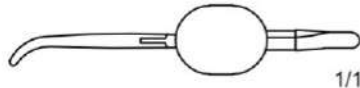

44-2203	50g
44-2213	80g

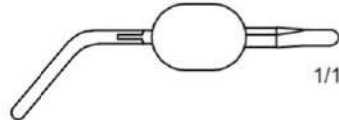

44-2204	50g
44-2214	80g

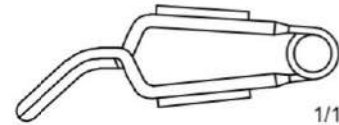

44-2205	50g
44-2215	80g

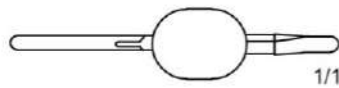

44-2220	Ligature Forceps/ Jaw Profile Finely Cross-Serrated
---------	--



**YASARGIL**  
Applying Forceps For Micro Vessel Clips  
44-2240 18.0cm

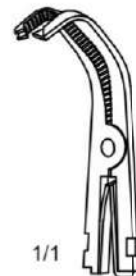

**YASARGIL**  
Micro Vessel Clips  
44-2230 32mm

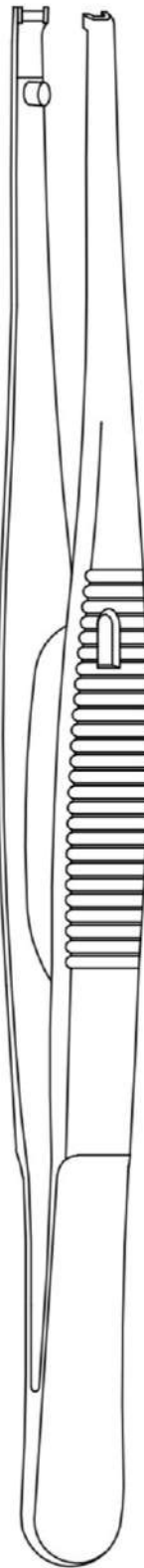

**BIEMER**  
Applying Forceps

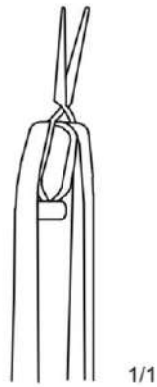

**BIEMER**

1/1

44-2301 without Lock  
44-2311 with Lock

For Vessel-Clips 044-1501~1503  
And Approximator p.499

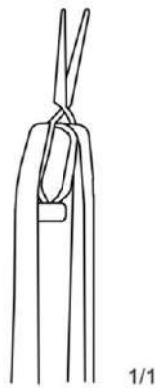

**BIEMER**

1/1

44-2302 without Lock

For Approximator 044-1901

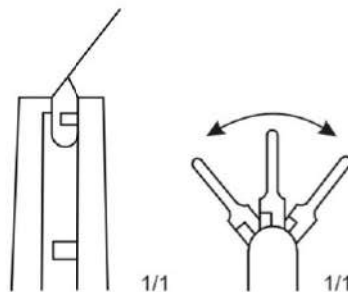

**MEHDORN**

1/1

1/1

44-2303 without Lock

For Vessel-Clips 044-1601~1604



1/1

Tips 1.5mm

02-1801	16.0cm
02-1802	20.0cm
02-1803	24.0cm
02-1804	30.0cm



1/1

Tips 1.5mm

02-1811	16.0cm
02-1812	20.0cm
02-1813	24.0cm
02-1814	30.0cm

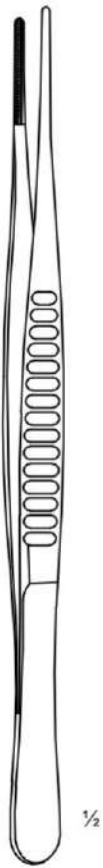

1/2

**DE BAKEY**

20.0cm

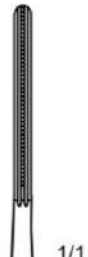

1/1

Tips 2.0mm

02-1901	16.0cm
02-1902	20.0cm
02-1903	24.0cm
02-1904	30.0cm



1/1

Tips 2.0mm

02-1911	16.0cm
02-1912	20.0cm
02-1913	24.0cm
02-1914	30.0cm

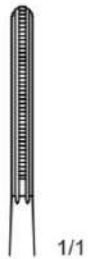

1/1

Tips 2.4mm

02-2001	16.0cm
02-2002	20.0cm
02-2003	24.0cm
02-2004	30.0cm

02-2101	16.0cm
02-2102	20.0cm
02-2103	24.0cm
02-2104	30.0cm

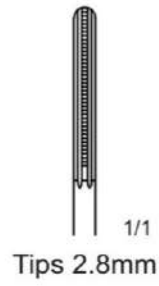

02-2111	16.0cm
02-2112	20.0cm
02-2113	24.0cm
02-2114	30.0cm

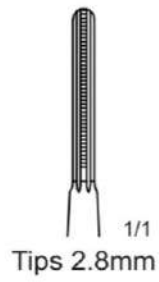

02-2201	16.0cm
02-2202	20.0cm
02-2203	24.0cm
02-2204	30.0cm



02-2211	16.0cm
02-2212	20.0cm
02-2213	24.0cm
02-2214	30.0cm

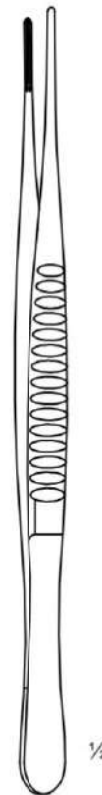

**DE BAKHEY**  
20.0cm





1/1  
Straight

44-2401 35mm

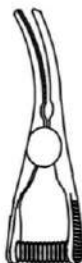

1/1

44-2411 30mm

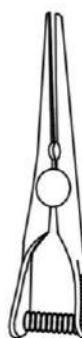

1/1

Straight

44-2402 48mm



1/1

Curved

44-2412 45mm

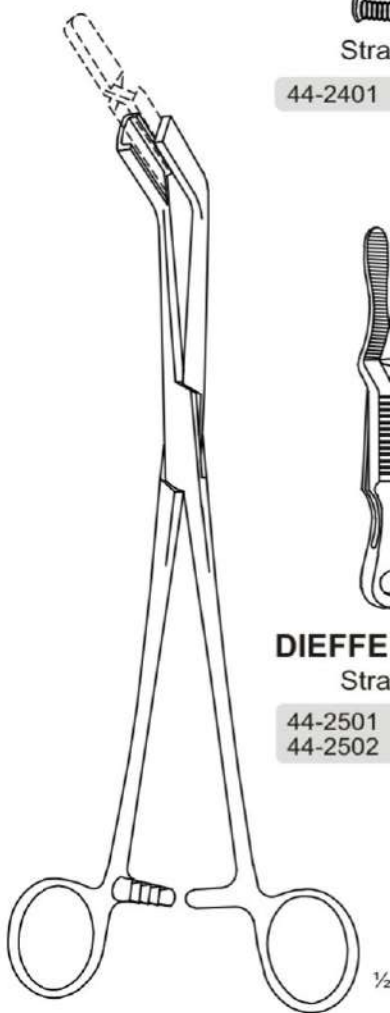

1/2

**JOHNS-HOPKINS**

44-2800 22.0cm

Forceps for Applying and Removing Bulldog Clamps  
044-2501~2700 and 044-3001~3014



1/1

**DIEFFENBACH**  
Straight

44-2501 38mm  
44-2502 48mm



1/1

**DIEFFENBACH**  
Curved

44-2511 38mm  
44-2512 48mm



1/1

**DIEFFENBACH**  
Straight

44-2503 58mm



1/1

**DIEFFENBACH**  
Curved

44-2513 58mm

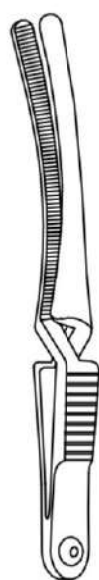

**JOHNS-HOPKINS**

44-2601 38mm  
44-2602 50mm  
44-2603 57mm  
44-2604 63mm  
44-2605 70mm  
44-2606 76mm



1/1

**DE BAKEY-HESS**

44-2700 Length of Jaws: 20mm



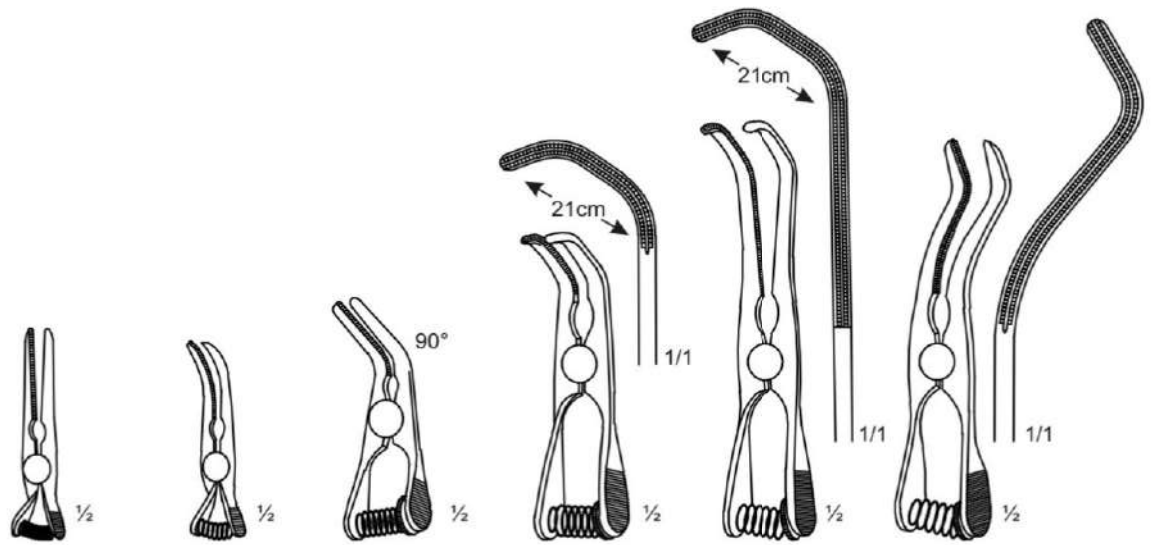

**DE BAKEY DE BAKEY GLOVER DE BAKEY DE BAKEY DE BAKEY**

	44-2910	44-2920	44-2930	44-2940	44-2950	44-2960
Total Length	48mm	45mm	65mm	65mm	99mm	90mm
Length of Jaws	27mm	27mm	35mm	38mm	63mm	54mm



**DE BAKEY**

Total Length Length of Jaws

44-3001	80mm	25mm
44-3002	90mm	35mm
44-3003	105mm	50mm
44-3004	128mm	68mm



**DE BAKEY**

Total Length Length of Jaws

44-3011	75mm	25mm
44-3012	85mm	35mm
44-3013	98mm	50mm
44-3014	115mm	68mm

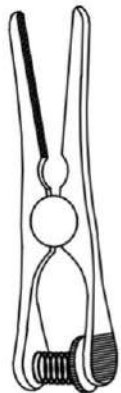

**GLOVER**

Total Length Length of Jaws

44-3101	65mm	33mm
44-3102	85mm	50mm
44-3103	110mm	69mm

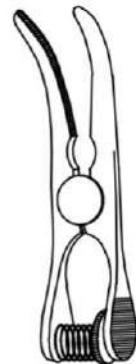

**GLOVER**

Total Length Length of Jaws

44-3111	65mm	33mm
44-3112	85mm	50mm
44-3113	110mm	69mm

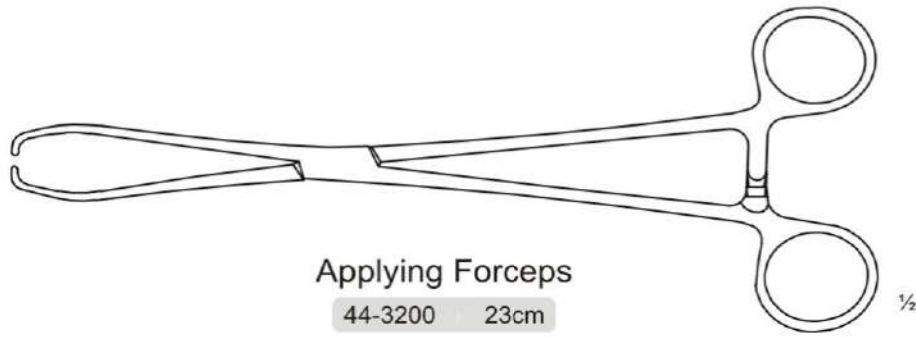

Applying Forceps

44-3200 23cm



◀ V (vena)=Low Pressure



◀ A (Arteria)=High Pressure

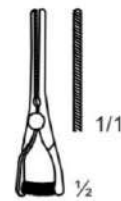
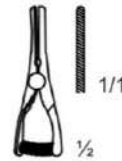
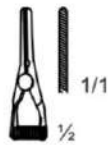

Identification	V = Vena	A = Arteria	V = Vena	A = Arteria	V = Vena	A = Arteria	V = Vena	A = Arteria
Cat No.	<b>44-3201</b>	<b>44-3301</b>	<b>44-3202</b>	<b>44-3302</b>	<b>44-3203</b>	<b>44-3303</b>	<b>44-3204</b>	<b>44-3304</b>
Length	30mm		35mm		40mm		50mm	
Length of Jaws	9mm		13mm		14mm		23mm	
Occlusion Pressure	110 ± 10 g	220 ± 10 g	110 ± 10 g	220 ± 10 g	110 ± 10 g	220 ± 10 g	110 ± 10 g	220 ± 10 g
Weight	1 g		1 g		1 g		1.5 g	

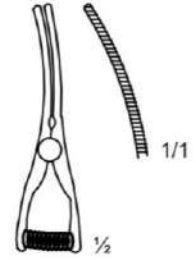
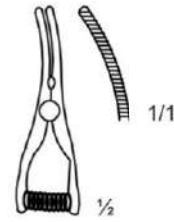
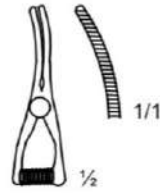
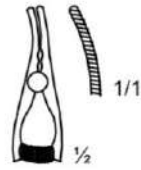

Identification	V = Vena	A = Arteria	V = Vena	A = Arteria	V = Vena	A = Arteria	V = Vena	A = Arteria
Cat No.	<b>44-3211</b>	<b>44-3311</b>	<b>44-3212</b>	<b>44-3312</b>	<b>44-3213</b>	<b>44-3313</b>	<b>44-3214</b>	<b>44-3314</b>
Length	30mm		35mm		40mm		48mm	
Length of Jaws	9mm		13mm		14mm		22mm	
Occlusion Pressure	110 ± 10 g	220 ± 10 g	110 ± 10 g	220 ± 10 g	110 ± 10 g	220 ± 10 g	110 ± 10 g	220 ± 10 g
Weight	1 g		1 g		1 g		1.5 g	

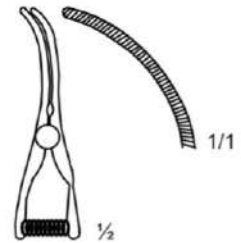
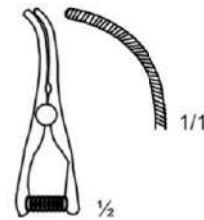
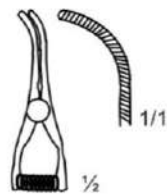
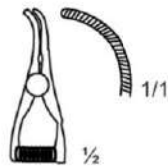

Identification	V = Vena	A = Arteria	V = Vena	A = Arteria	V = Vena	A = Arteria	V = Vena	A = Arteria
Cat No.	<b>44-3221</b>	<b>44-3321</b>	<b>44-3222</b>	<b>44-3322</b>	<b>44-3223</b>	<b>44-3323</b>	<b>44-3224</b>	<b>44-3324</b>
Length	30mm		35mm		40mm		45mm	
Length of Jaws	10mm		14mm		15mm		21mm	
Occlusion Pressure	110 ± 10 g	220 ± 10 g	110 ± 10 g	220 ± 10 g	110 ± 10 g	220 ± 10 g	110 ± 10 g	220 ± 10 g
Weight	1 g		1 g		1 g		1.5 g	

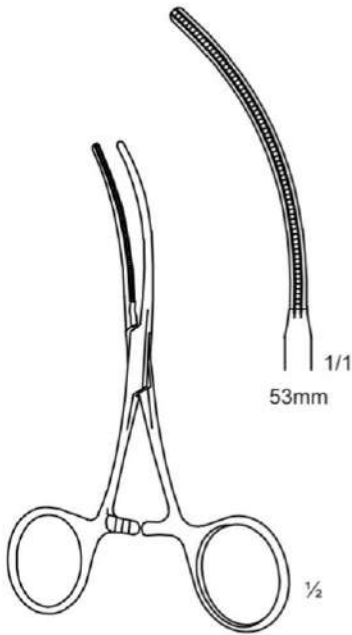

**DE BAKEY**

44-3410 13.0cm

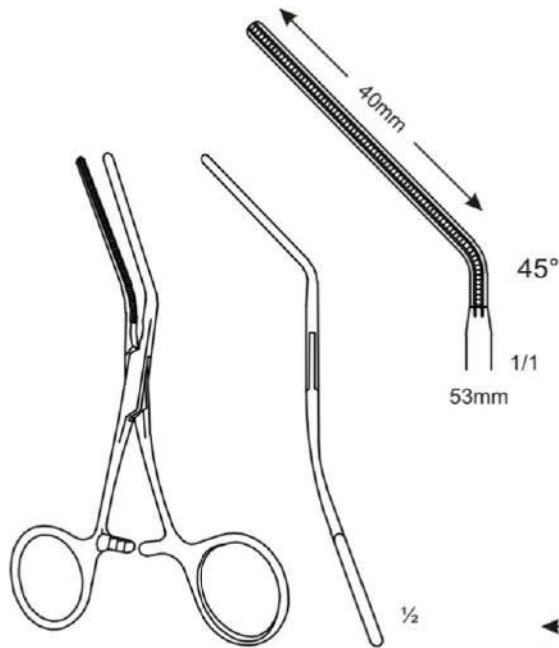

**DE BAKEY**

44-3420 12.5cm

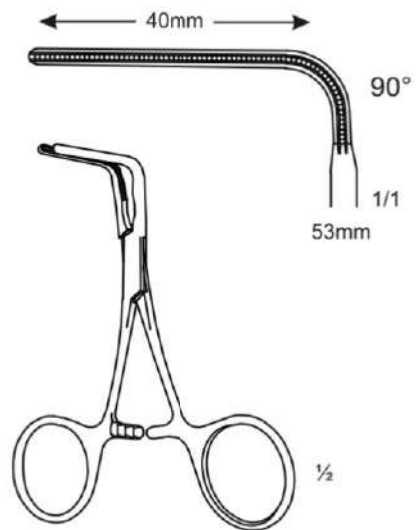

**DE BAKEY**

44-3430 10.5cm

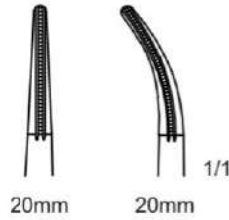
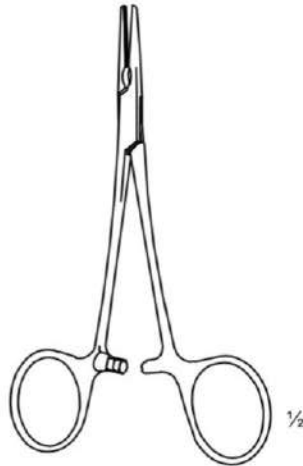

### DE BAKE-MOSQUITO

- 44-3501 Straight
- 44-3511 Curved

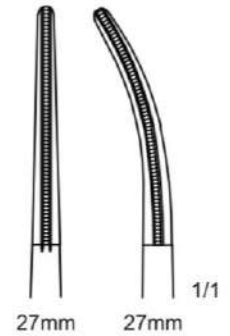
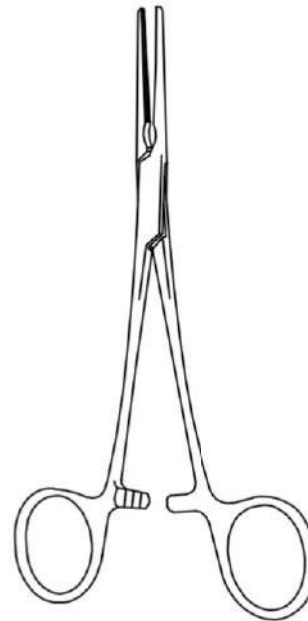

### DE BAKE-MOSQUITO

- 44-3502 Straight
- 44-3512 Curved

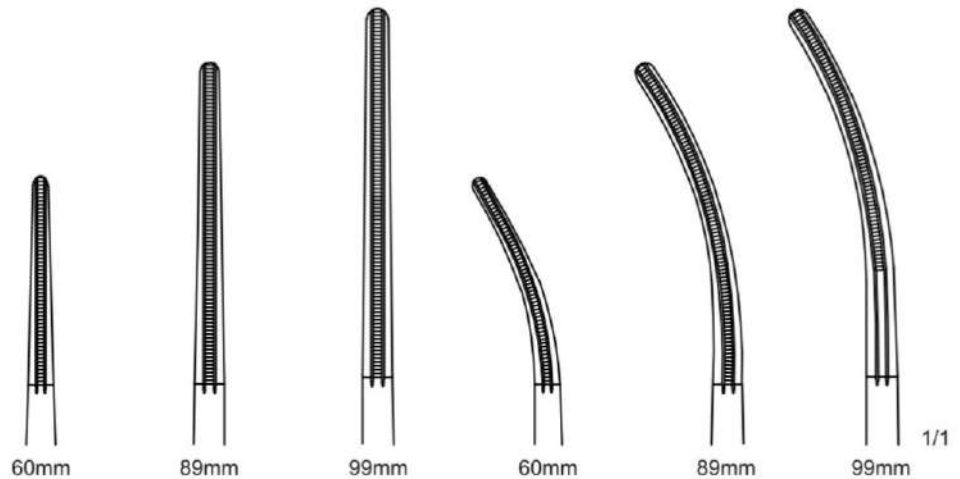
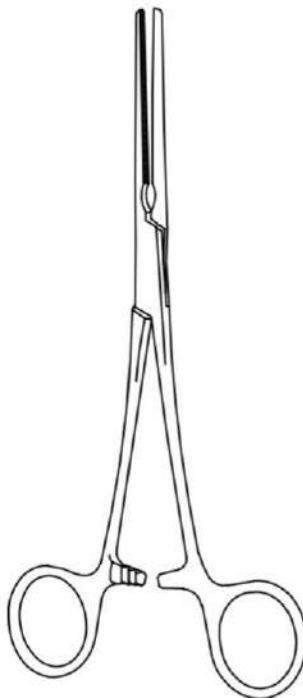

### DE BAKE-PEAN

- |         |        |          |
|---------|--------|----------|
| 44-3601 | 20.0cm | Straight |
| 44-3602 | 26.0cm | Straight |
| 44-3603 | 28.0cm | Straight |

- |         |        |        |
|---------|--------|--------|
| 44-3611 | 20.0cm | Curved |
| 44-3612 | 26.0cm | Curved |
| 44-3613 | 27.5cm | Curved |



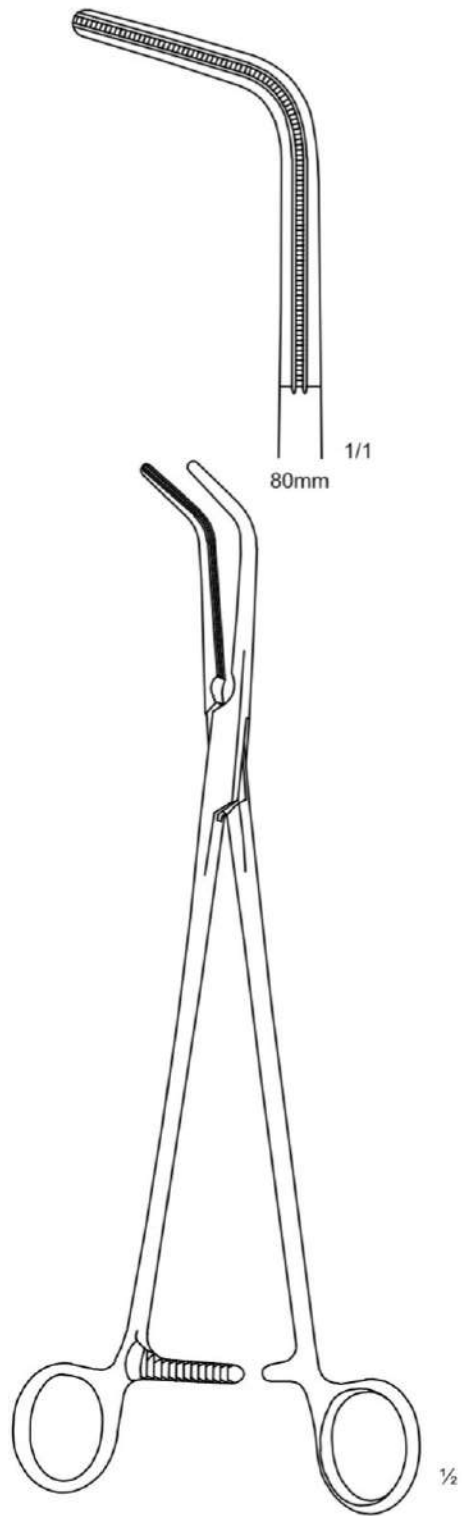

**DE BAKEY-MIXTER**

44-3700 28.5cm



**DE BAKEY**

44-3801	20.5cm	77mm
44-3802	22.2cm	80mm

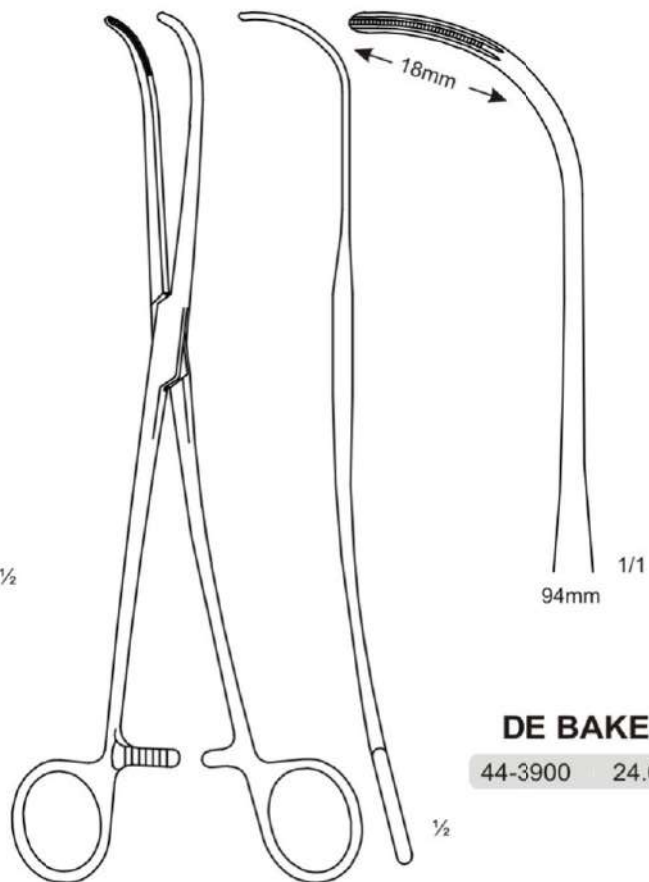

**DE BAKEY**

44-3900 24.0cm

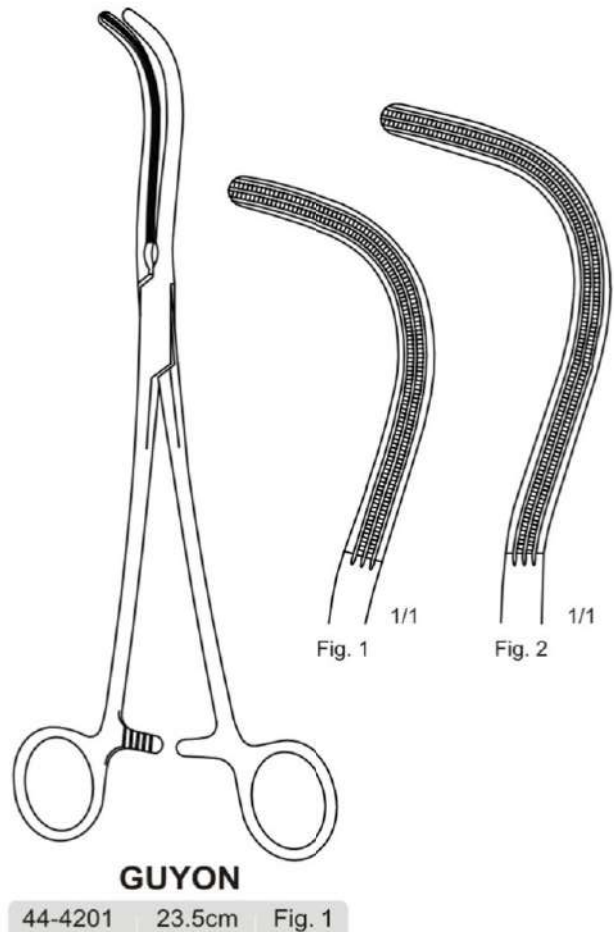
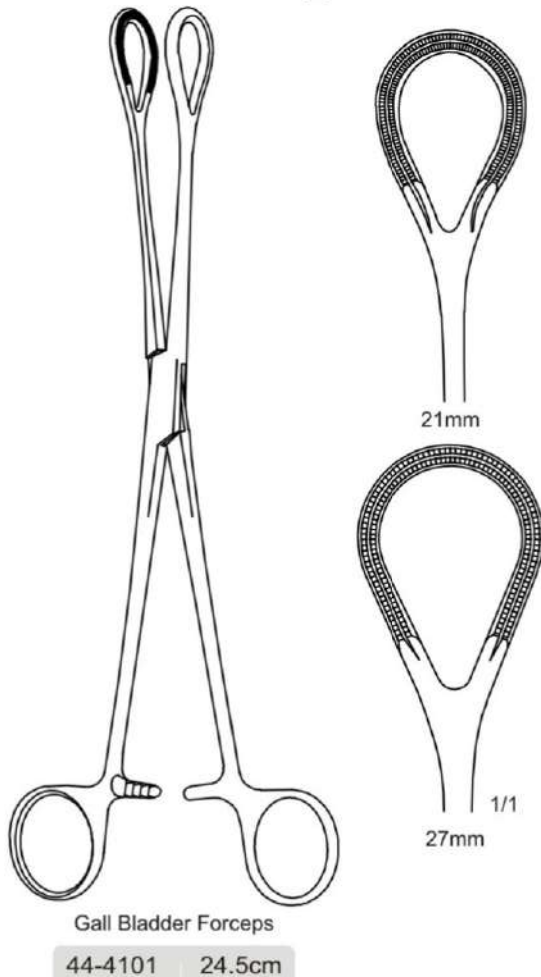
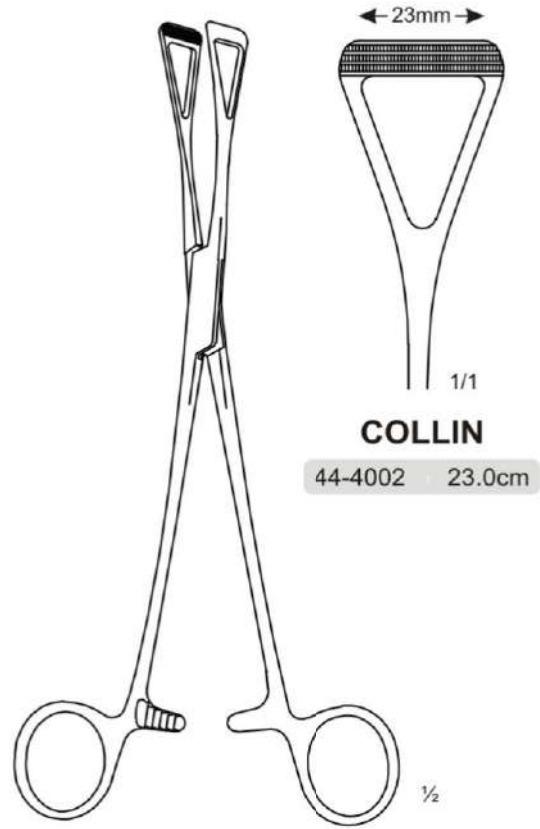
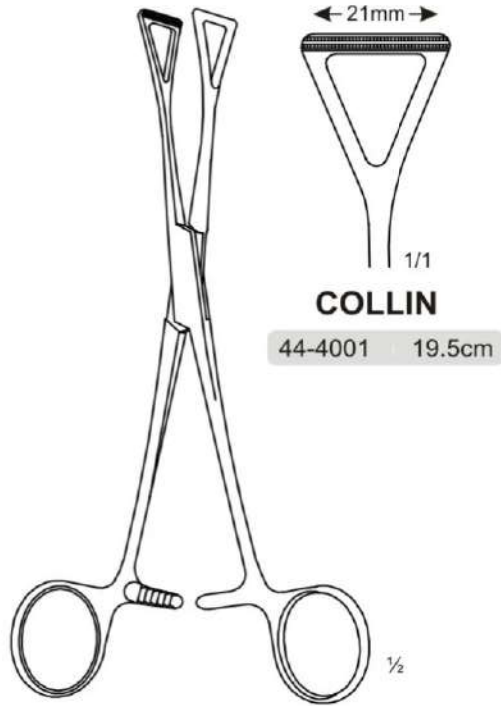



# Atraumatic Tangential Occlusion Clamps

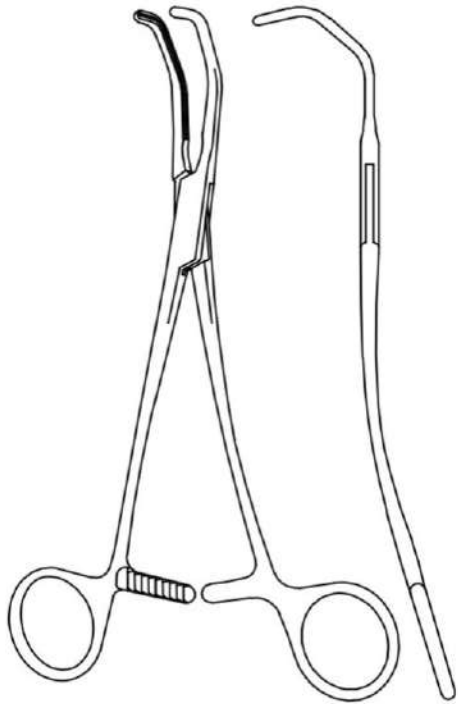

**DE BAKEY**

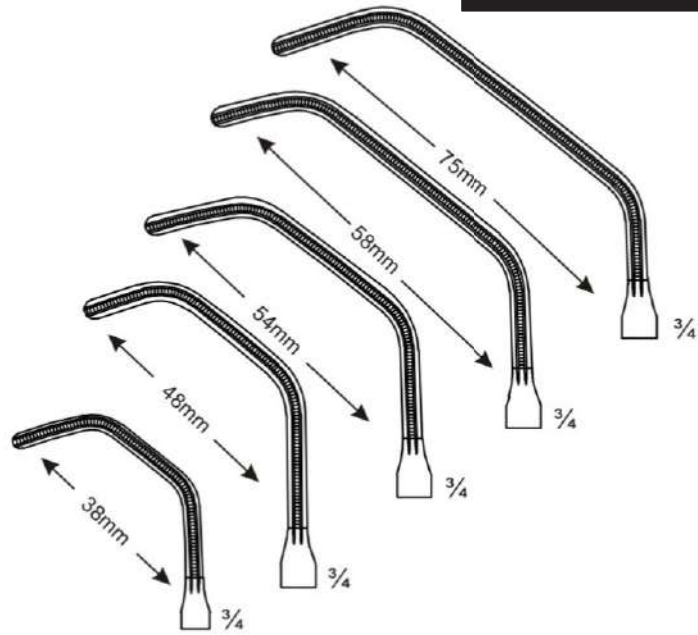

	44-4301	44-4302	44-4303	44-4304	44-4305
Total Length	22.0cm	26.0cm	27.0cm	27.0cm	27.5cm
Length of Jaws	85mm	95mm	99mm	103mm	119mm

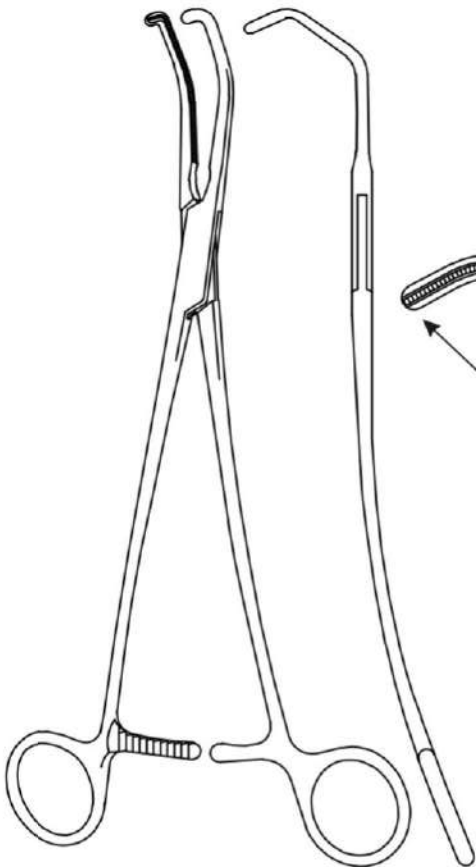

**DE BAKEY-SATINSKY**

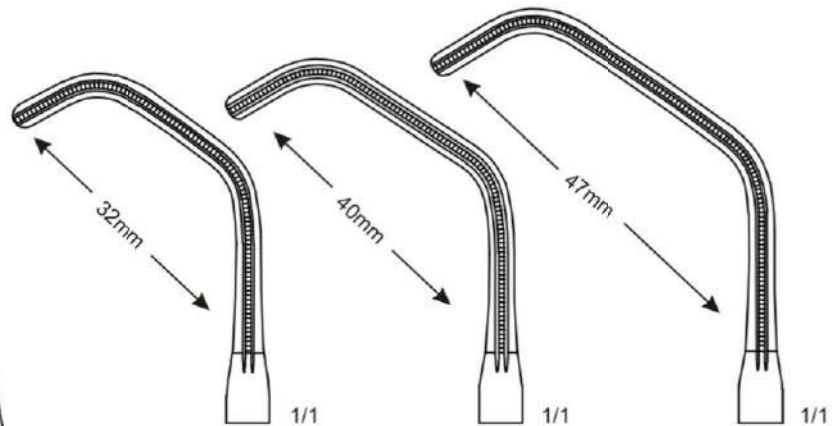

	44-4401	44-4402	44-4403
Total Length	26.0cm	26.0cm	26.0cm
Length of Jaws	68mm	78mm	84mm

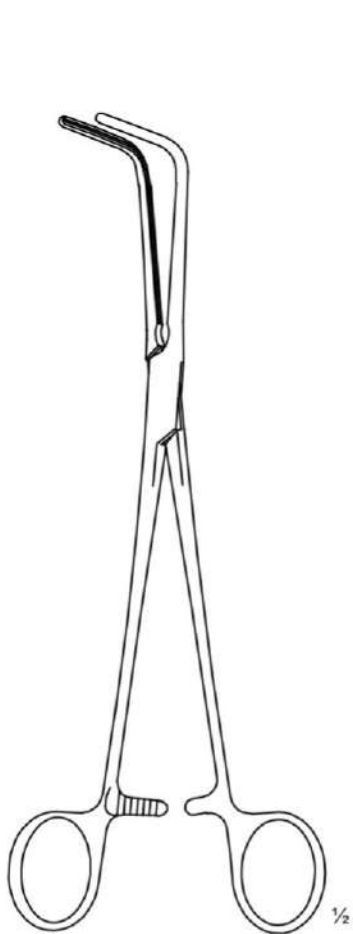
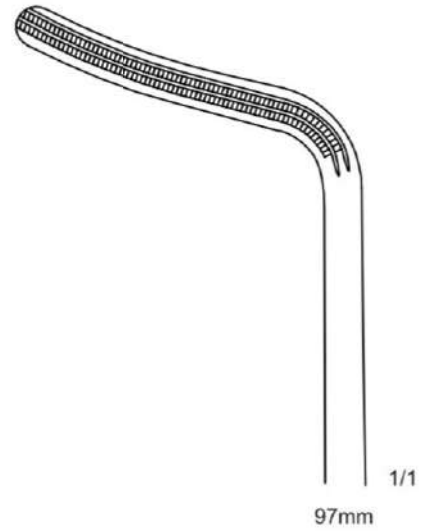
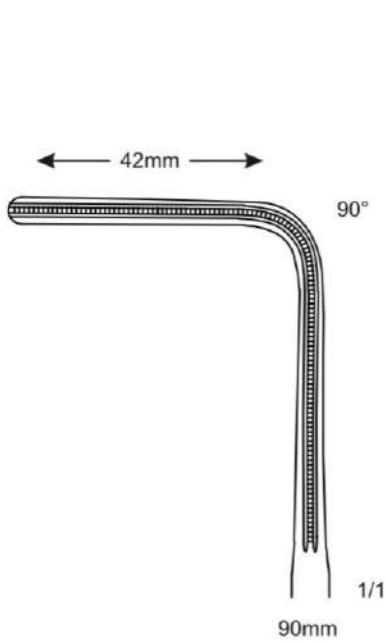

**LEES**

44-4501 23.0cm



**LEES**

44-4502 23.5cm

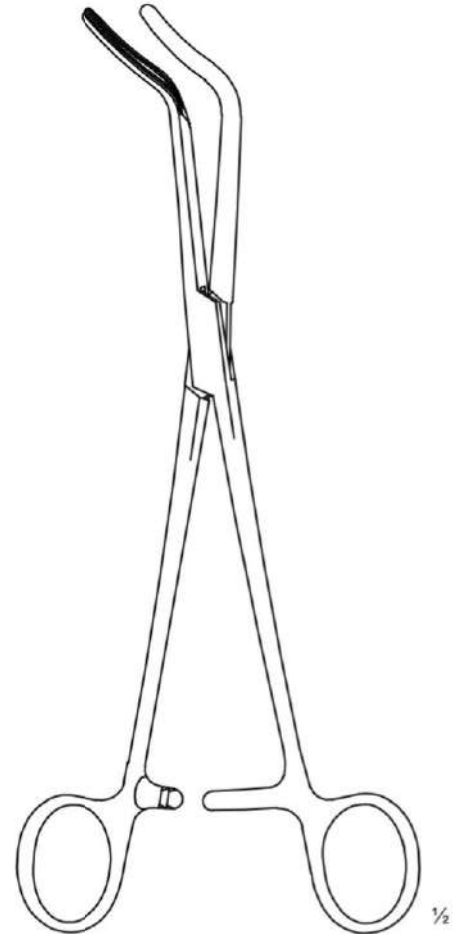

**ATLEE**

44-4600 24.5cm

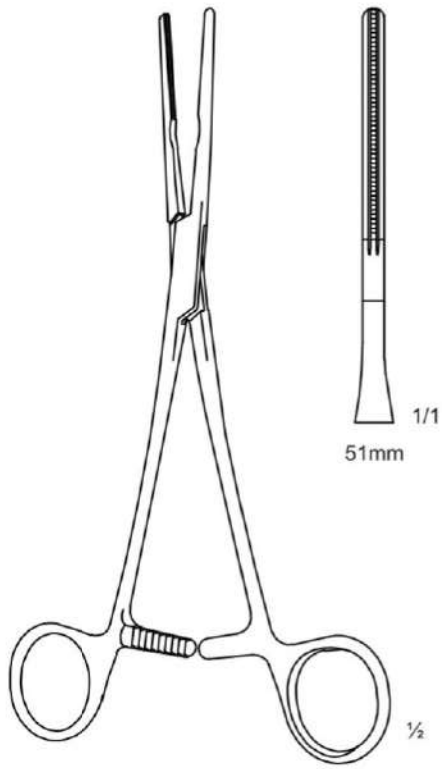

**DE BAKAY**  
44-4701 21.5cm

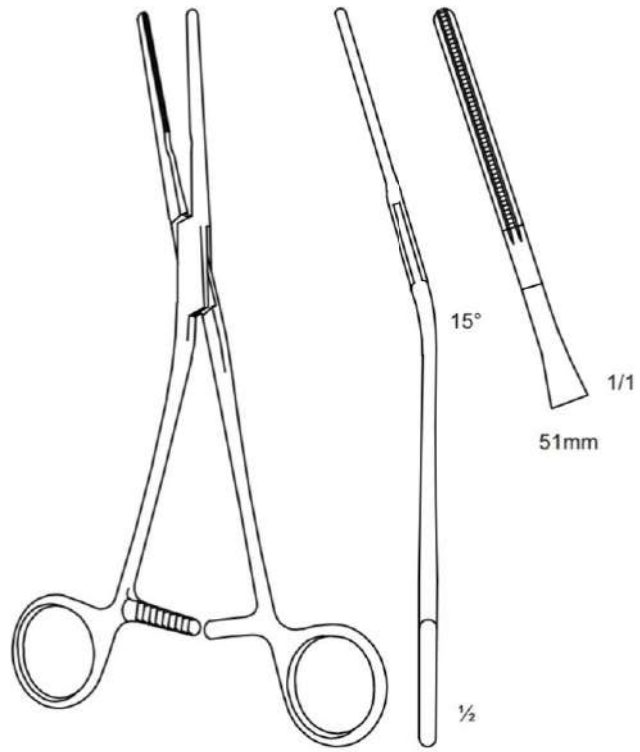

**DE BAKAY**  
44-4711 21.5cm

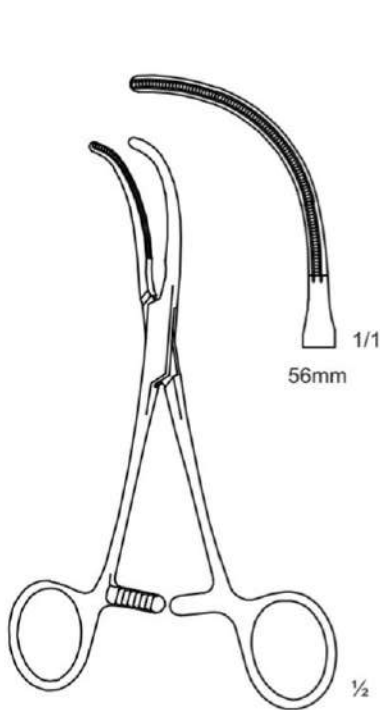

**DE BAKAY**  
44-4801 16.0cm

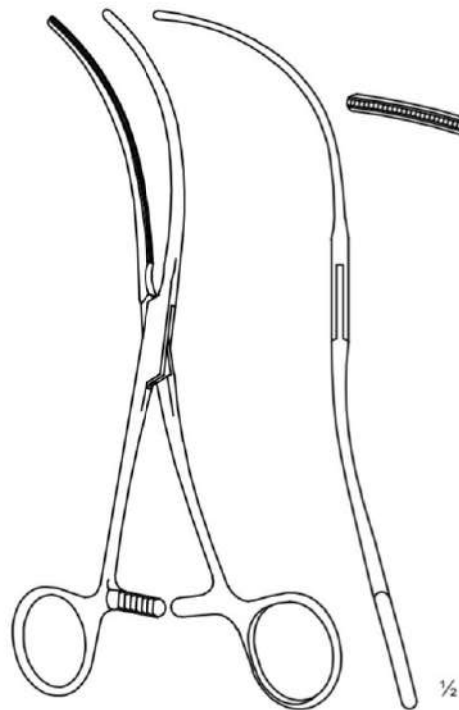

**DE BAKAY**  
44-4802 18.5cm 90mm  
44-4803 19.5cm 92.5mm

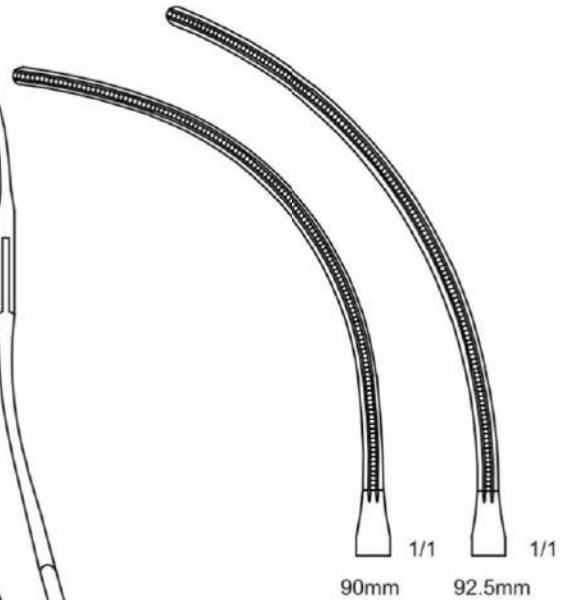

Atraumatic Instruments

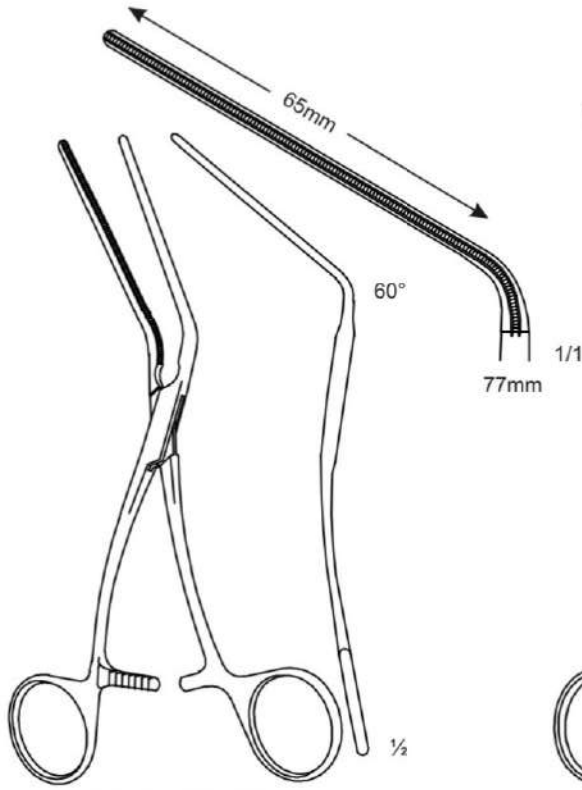

**DE BAKEY**

44-4900 18.5cm

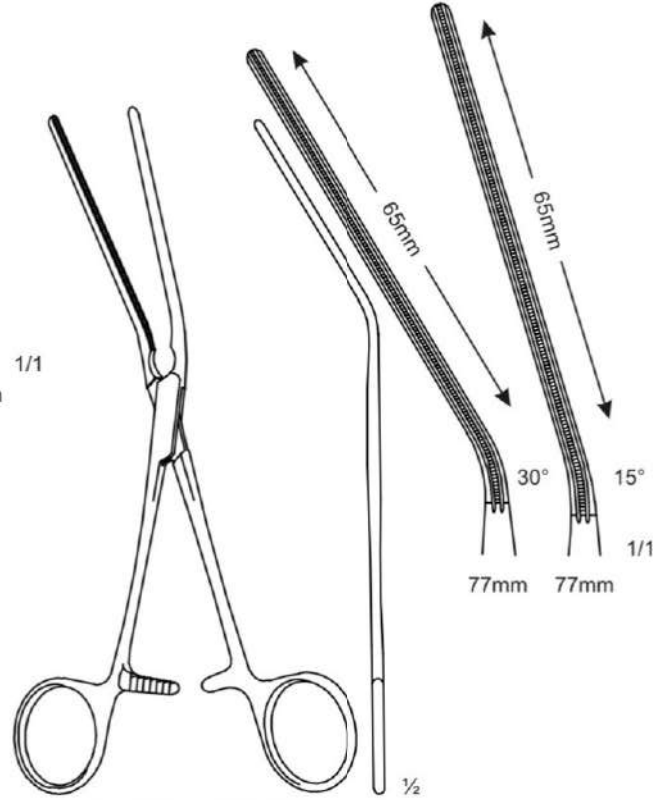

**LELAND-JONES**

44-5011 19.0cm 30°  
44-5012 19.0cm 50°

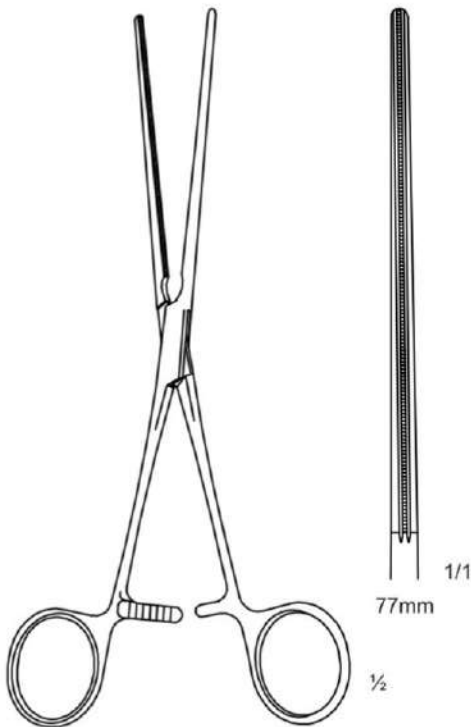

**LELAND-JONES**

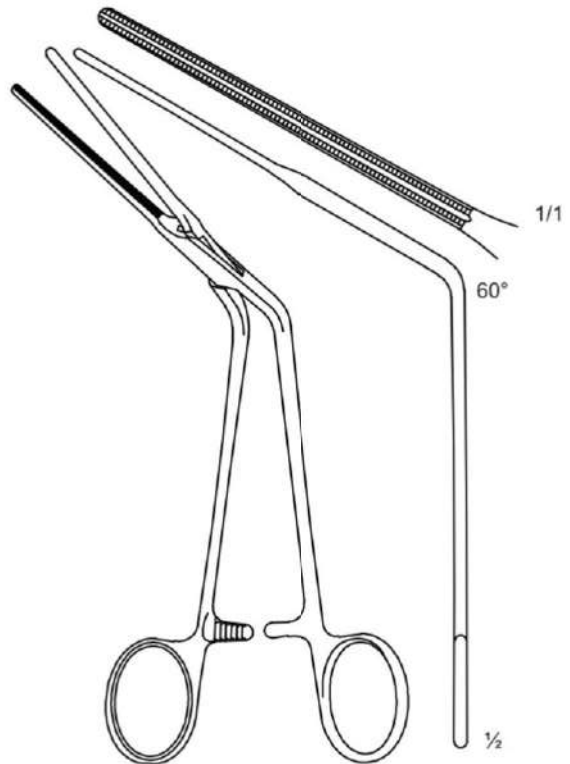

**DE BAKEY**

**Atraumatic Instruments**



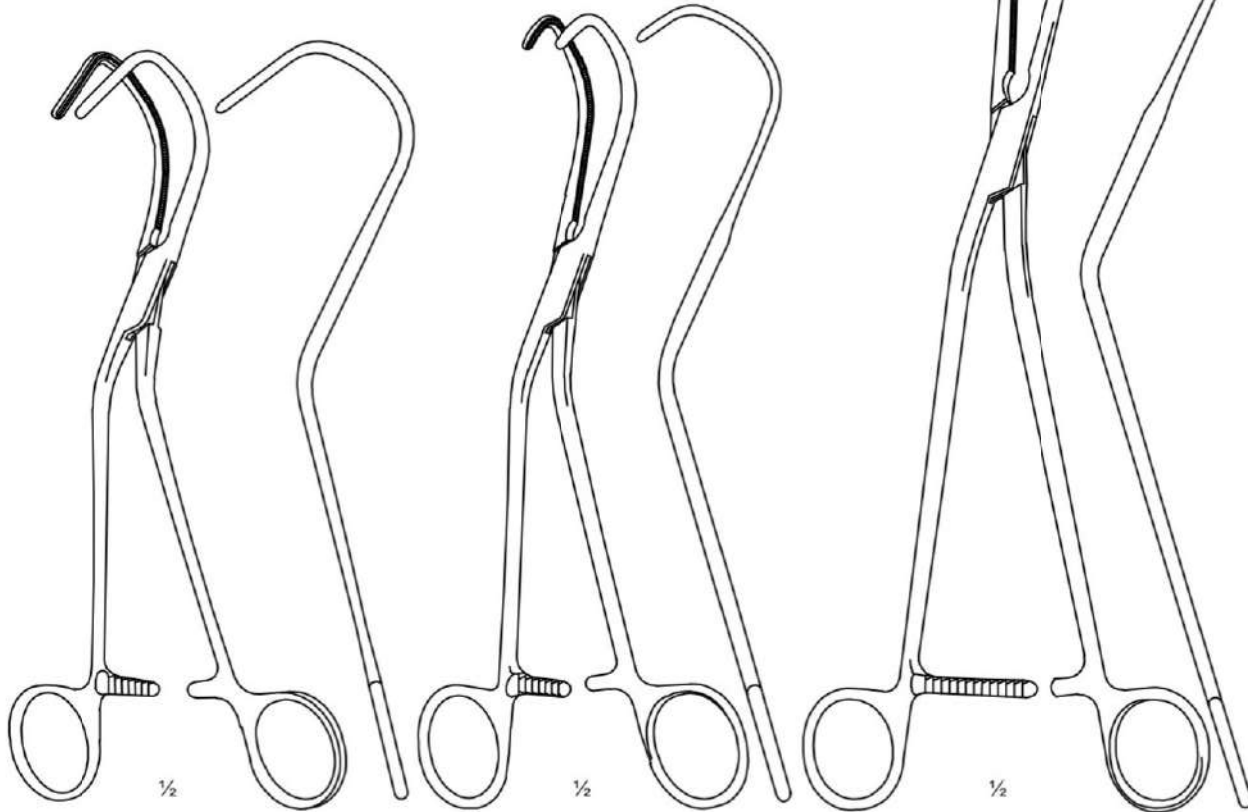
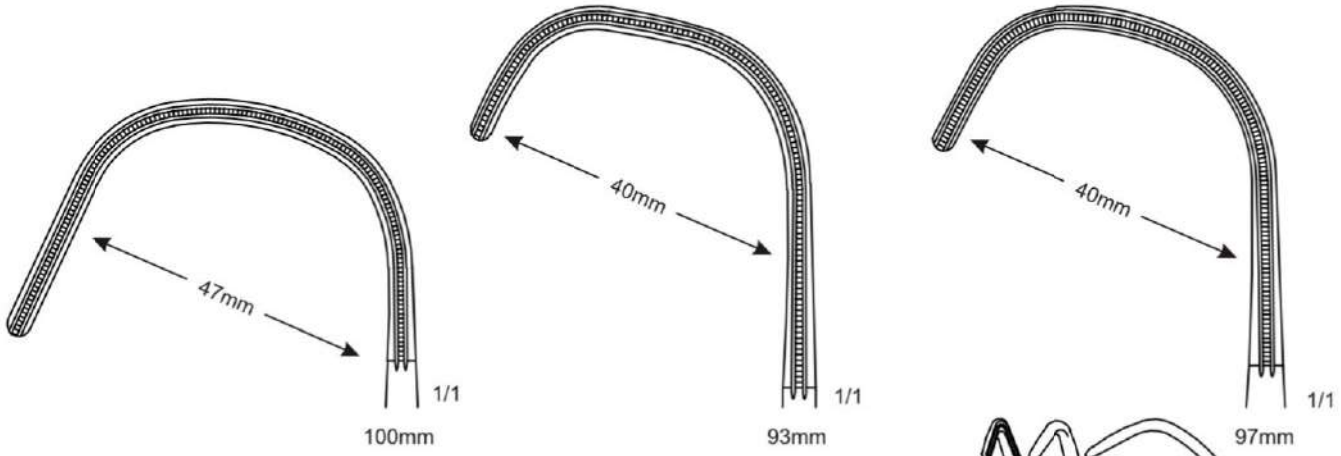

**LAMBERT-KAY**

44-5201 19.5cm

**LAMBERT-KAY**

44-5202 19.5cm

**DE BAKY**

44-5300 25.5cm

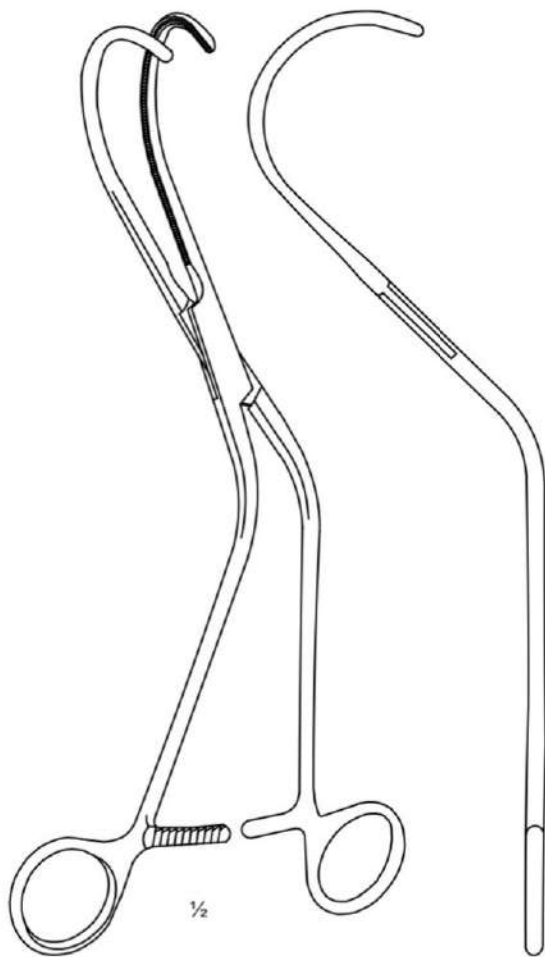
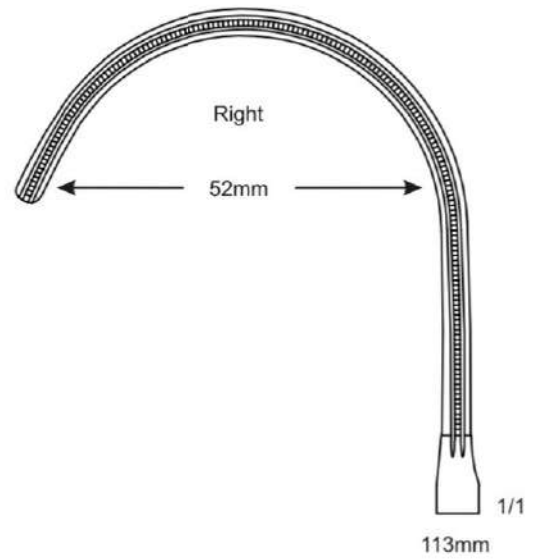
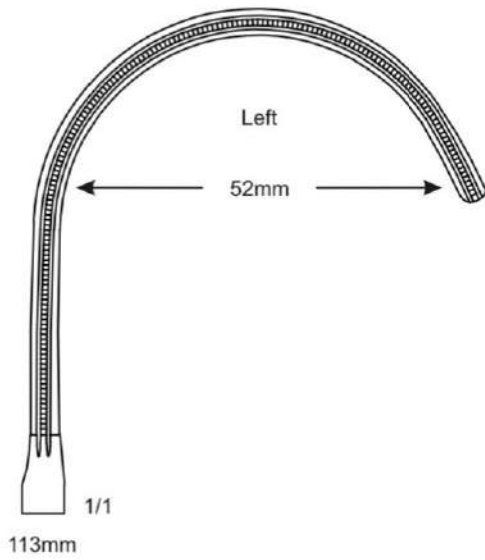

**WEBER**

44-5401 26.0cm

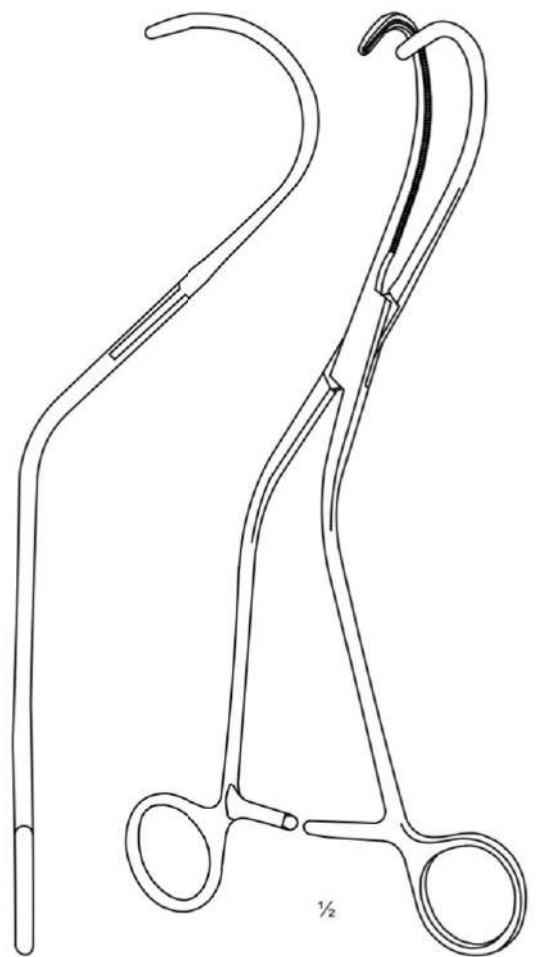

**WEBER**

44-5402 26.0cm

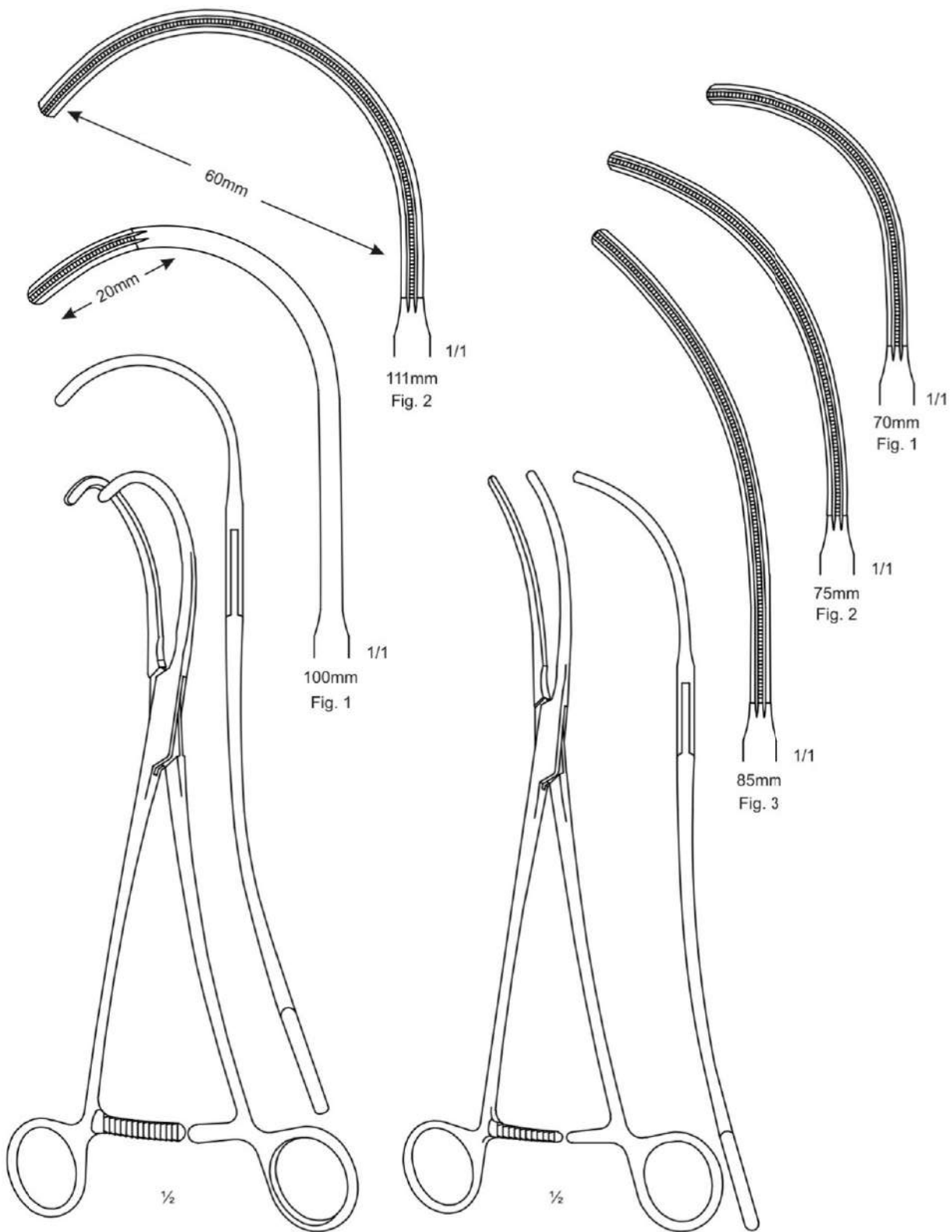

**DE BAKAY**

44-5501	27.0cm	Fig.1
44-5502	27.0cm	Fig.2

**DE BAKAY**

44-5601	26.0cm	Fig.1
44-5602	27.0cm	Fig.2
44-5603	28.0cm	Fig.3



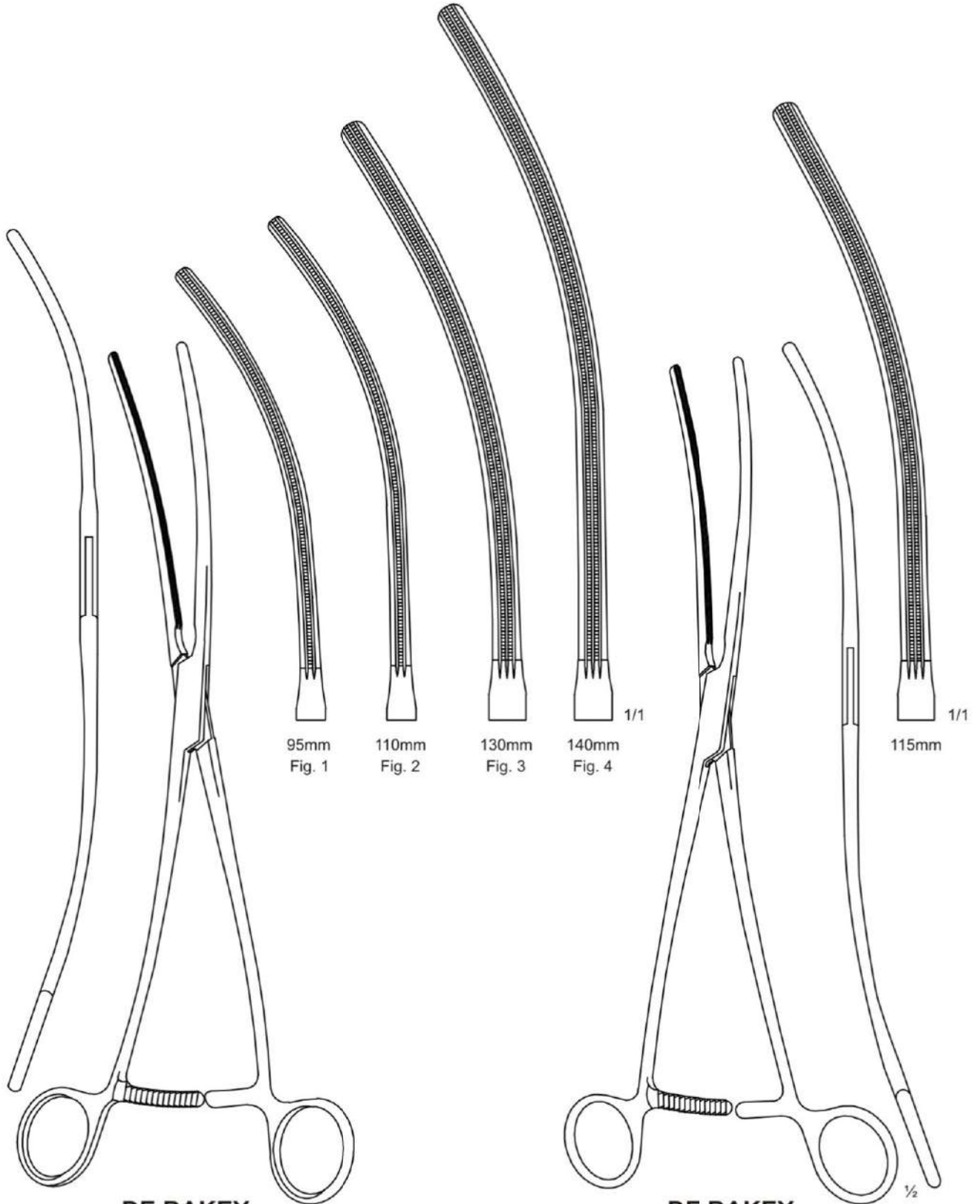

**DE BAKAY**  
C-Type

44-5701	25.5cm	Fig. 1
44-5702	27.0cm	Fig. 2
44-5703	31.5cm	Fig. 3
44-5704	33.0cm	Fig. 4

**DE BAKAY**

44-5800 30.0cm

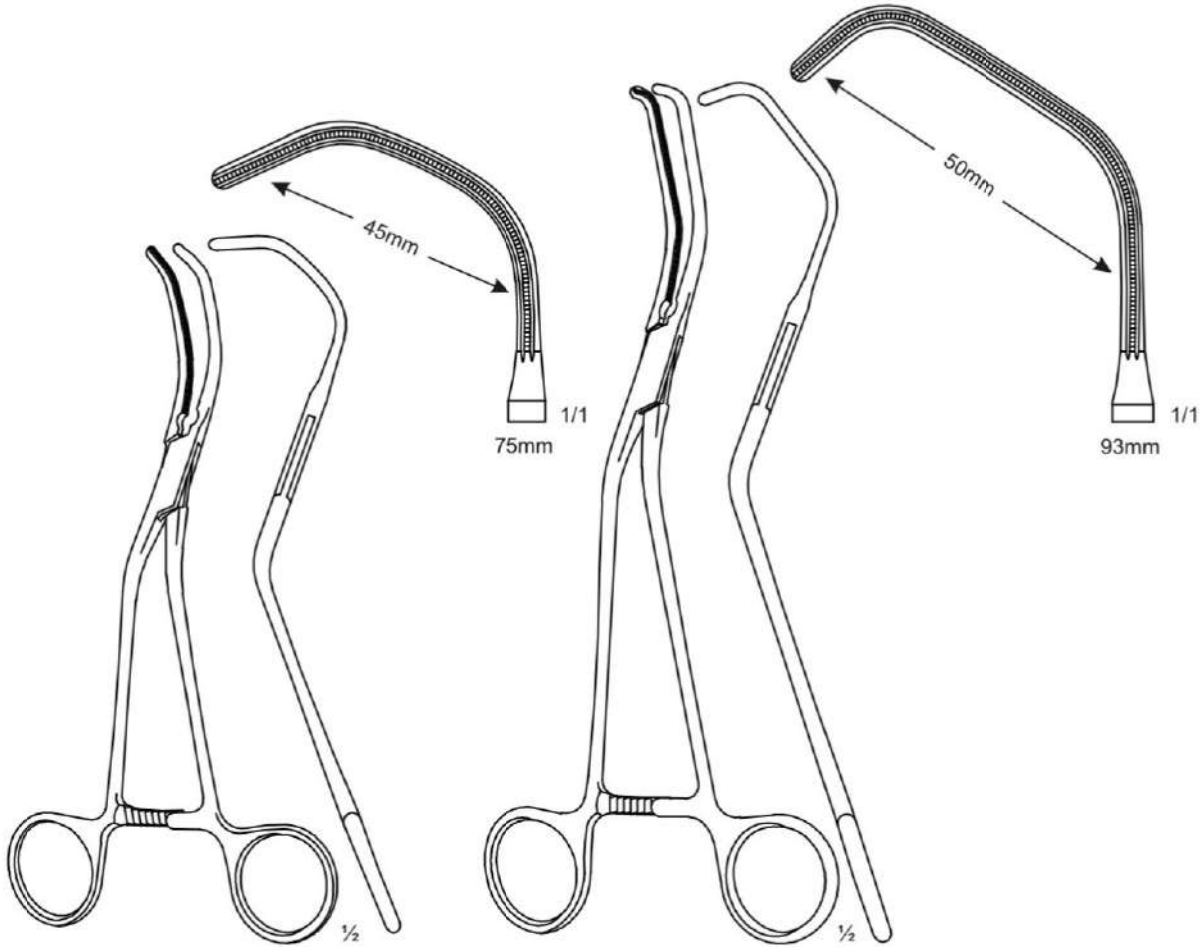

**DIETRICH**

44-5900 21.0cm

**OCHSNER**

44-6000 26.5cm

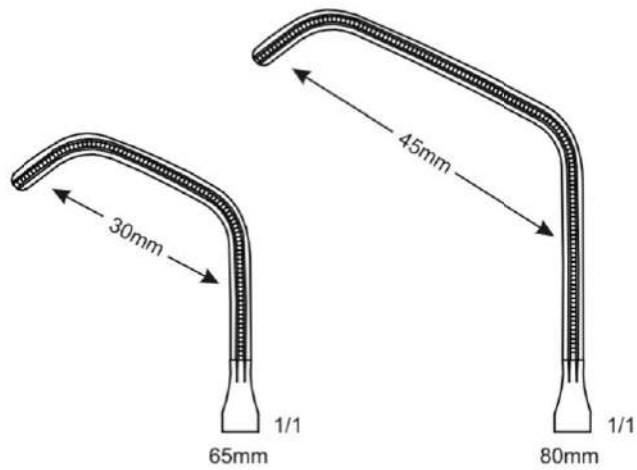
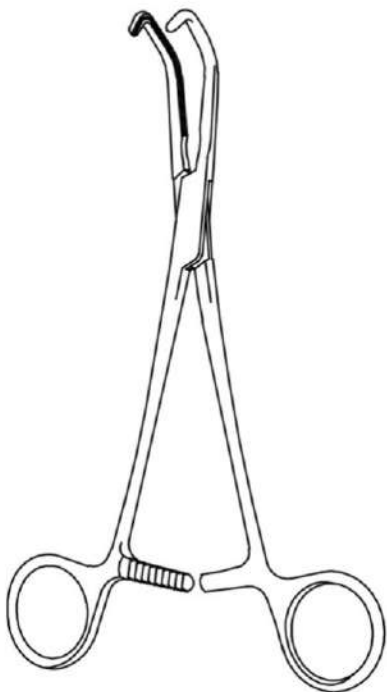

**DE BAKY-BECK**  
Vena-Cava Clamps

44-6101 19.0cm  
44-6102 21.0cm

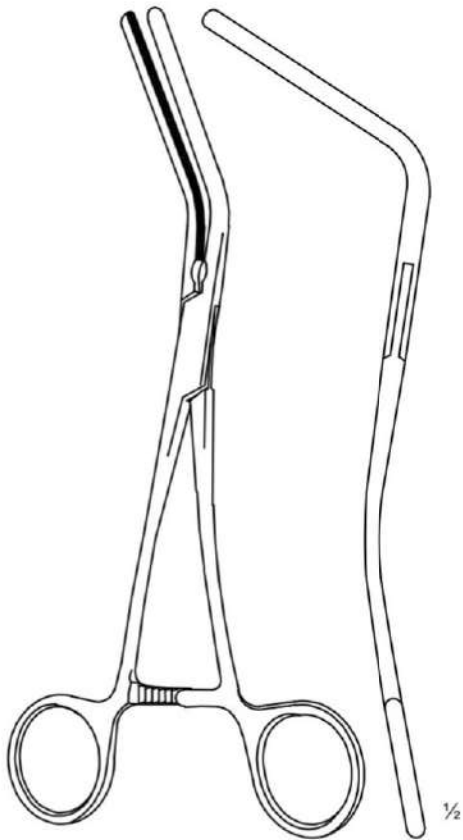
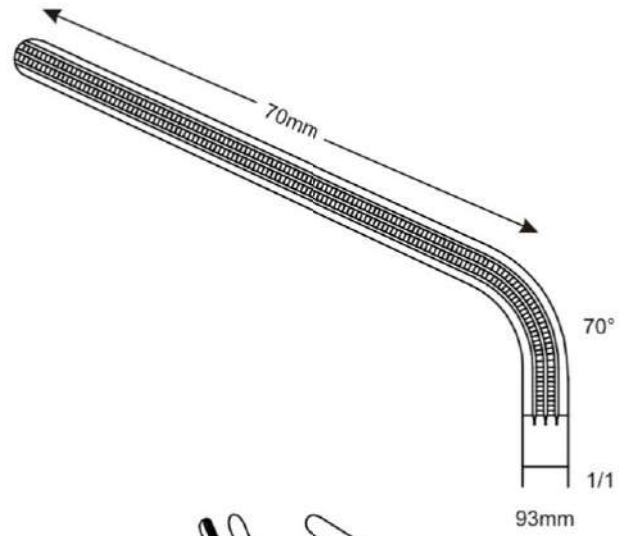
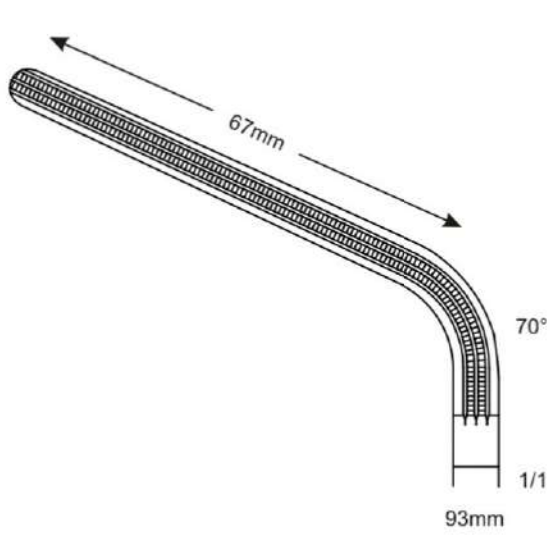

**MORRIS**

44-6201 20.0cm

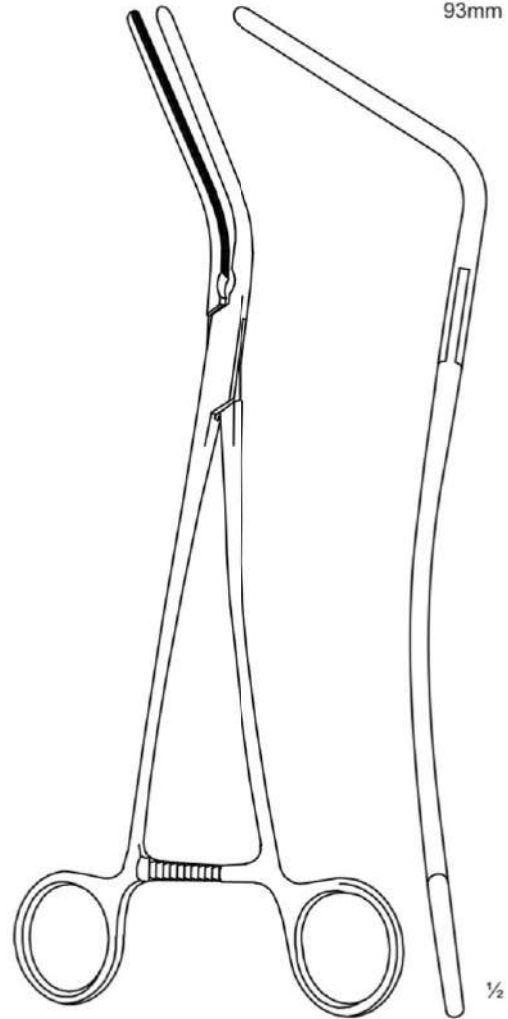

**DE BAKKEY**

44-6202 25.0cm

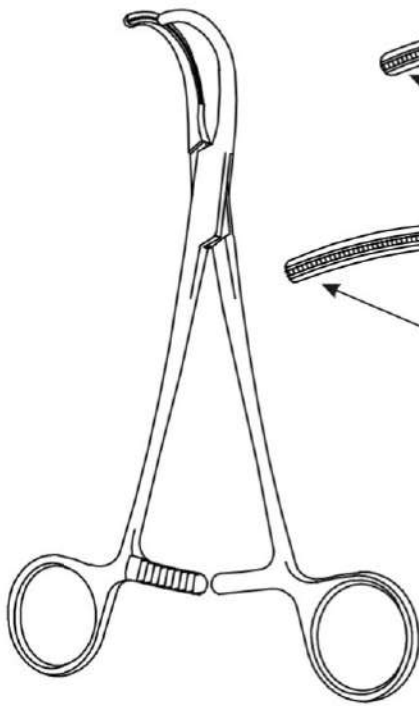

**GLOVER**

44-6301	18.0cm	70mm
44-6302	20.0cm	95mm

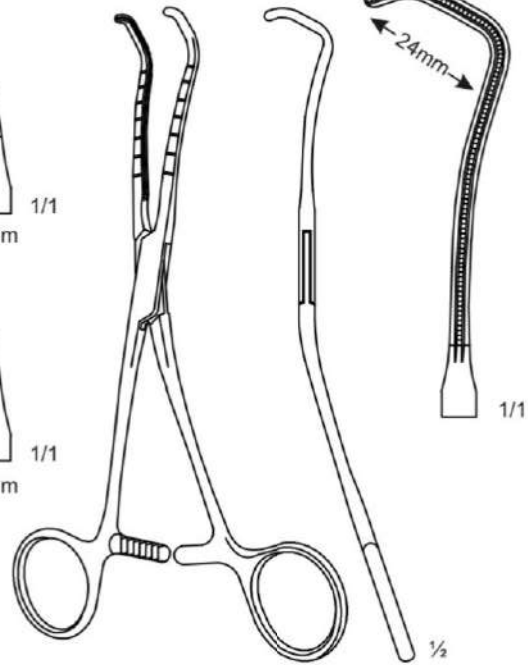
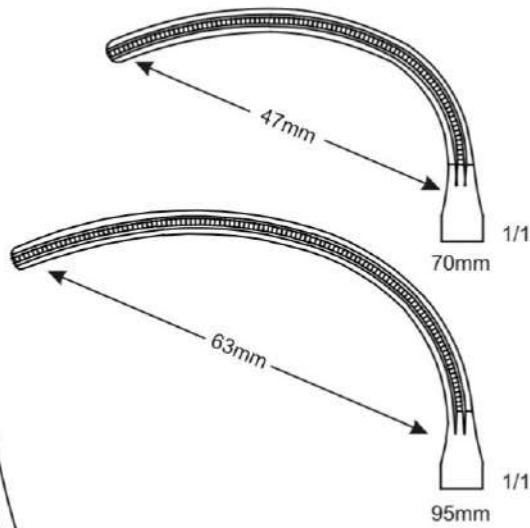

**COOLEY**

44-6400	17.0cm
---------	--------

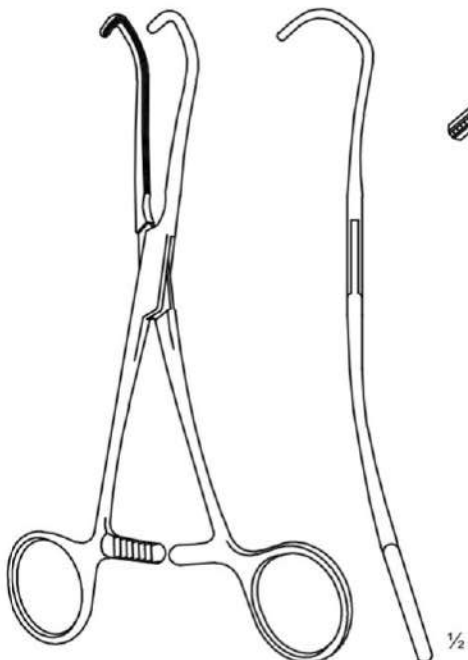

**DERRA**



Fig. 1

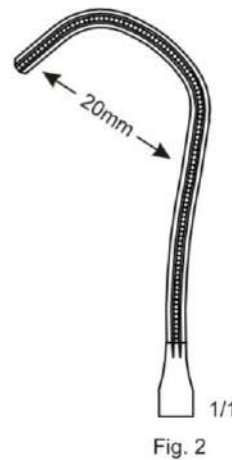

Fig. 2

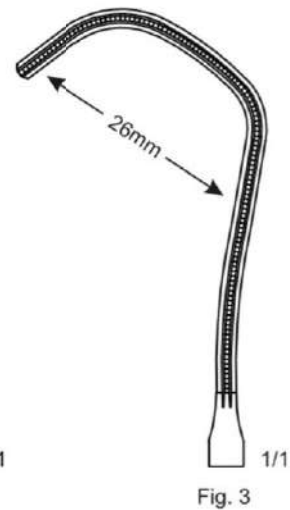
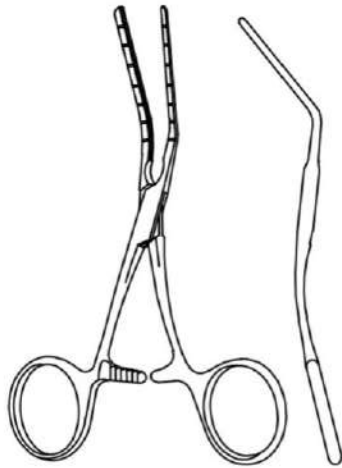

Fig. 3

44-6501	16.5cm	Fig. 1
44-6502	17.0cm	Fig. 2
44-6503	17.5cm	Fig. 3





**CASTANEDA**

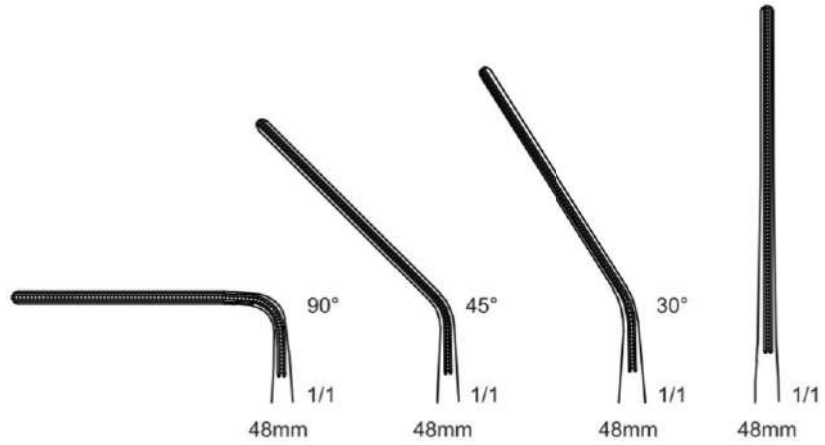

44-6601	12.5cm	Straight
44-6602	12.0cm	30°
44-6603	12.0cm	45°
44-6604	10.5cm	90°

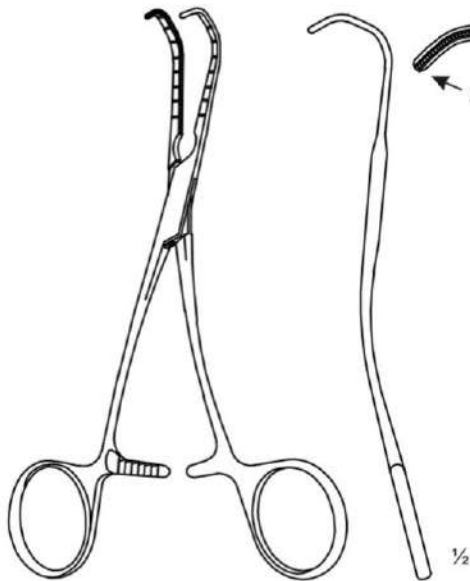

**CASTANEDA**

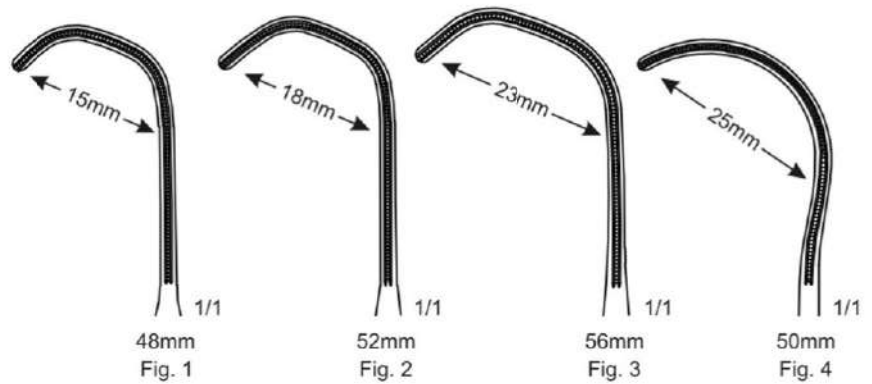

44-6701	Fig. 1
44-6702	Fig. 2
44-6703	Fig. 3
44-6704	Fig. 4



**OBGY Surgery**  
OBGY Surgery





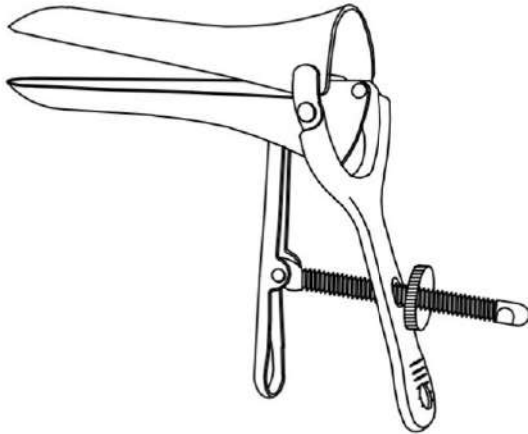

**CUSCO**

- ▶ 45-0101 Small
- ▶ 45-0102 Medium
- ▶ 45-0103 Large

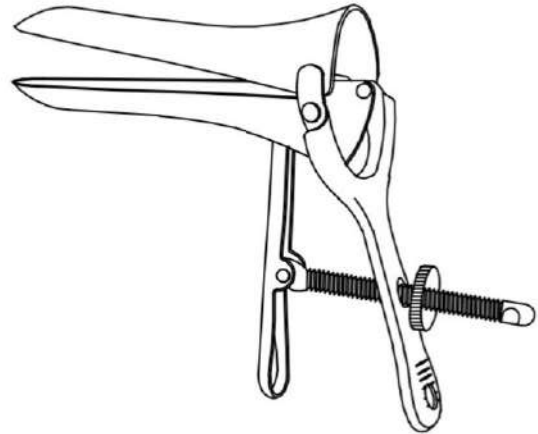

**CUSCO**

- ▶ 45-0110 Small Black
- ▶ 45-0120 Medium Black
- ▶ 45-0130 Large Black

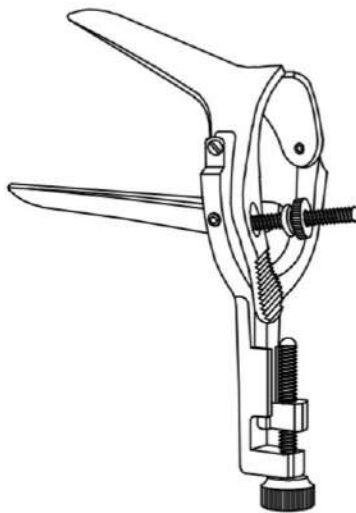

**SAKURAI'S**

- ▶ 45-0200

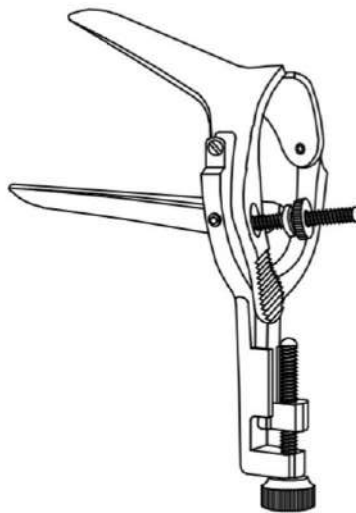

**SAKURAI'S**

- ▶ 45-0210 Black

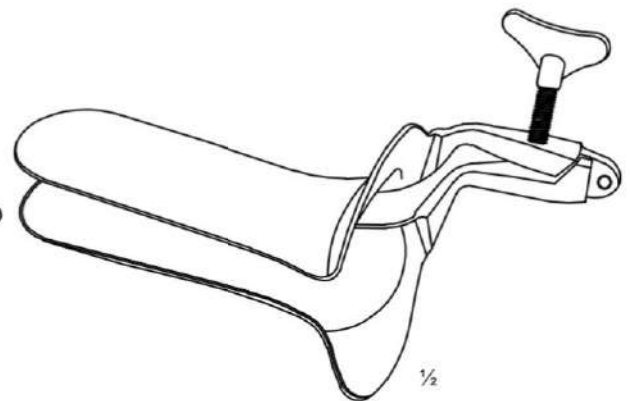

**COLLIN**

- 45-0301 85 x 29mm
- 45-0302 95 x 32mm
- 45-0303 100 x 35mm
- 45-0304 100 x 40mm

# Vaginal Retractors



- ▶ 45-0401 75 x 35mm
- ▶ 45-0402 90 x 35mm
- ▶ 45-0403 100 x 35mm

**EASTMAN**

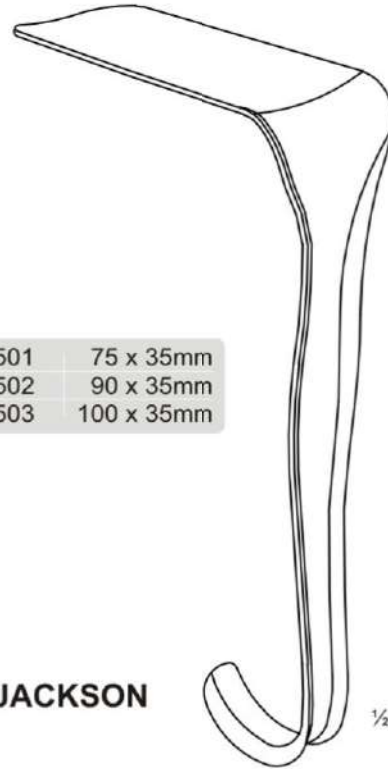

- ▶ 45-0501 75 x 35mm
- ▶ 45-0502 90 x 35mm
- ▶ 45-0503 100 x 35mm

**JACKSON**

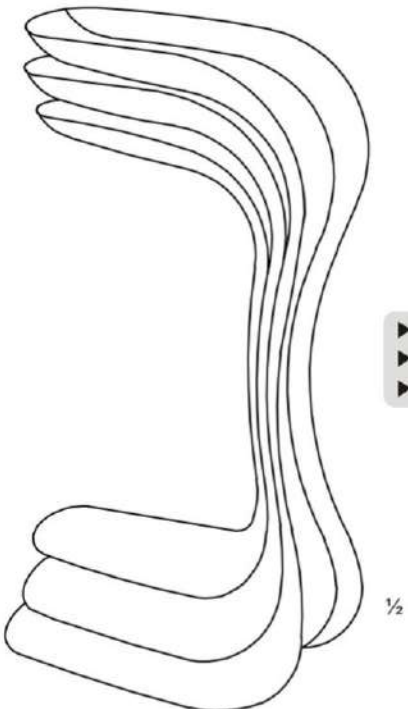

- ▶ 45-0601 60 x 25mm 60 x 30mm 12.5cm
- ▶ 45-0602 70 x 30mm 70 x 35mm 15.0cm
- ▶ 45-0603 80 x 35mm 80 x 40mm 17.5cm

**SIMS**  
Double Ended

▶ 45-0701	Small	110 x 27mm
▶ 45-0702	Medium	110 x 30mm
▶ 45-0703	Large	110 x 36mm

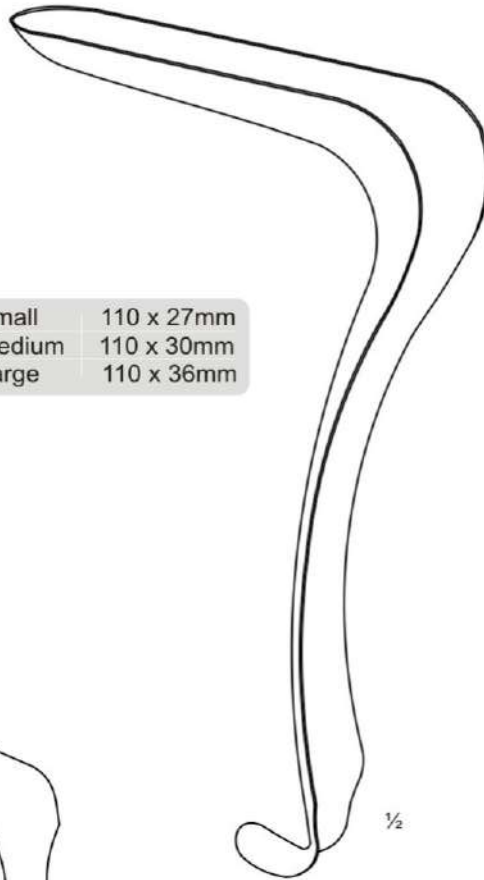

**SIMS**  
Single Ended

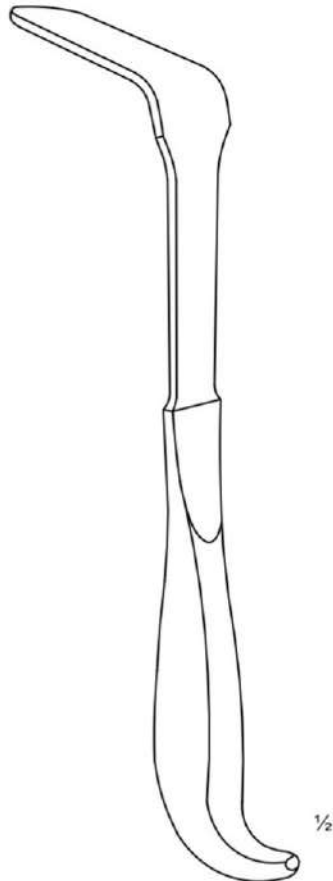

**HEANEY-SIMON**

45-0801	60 x 30mm	24.0cm
45-0802	70 x 30mm	24.0cm
45-0803	80 x 30mm	24.0cm

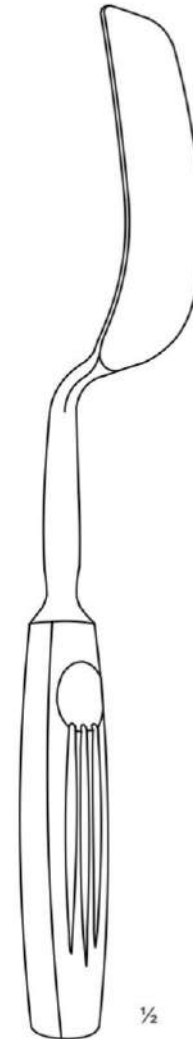

**BREISKY**

45-0901	120 x 20mm
45-0902	120 x 25mm
45-0903	120 x 30mm
45-0904	120 x 35mm
45-0905	120 x 40mm

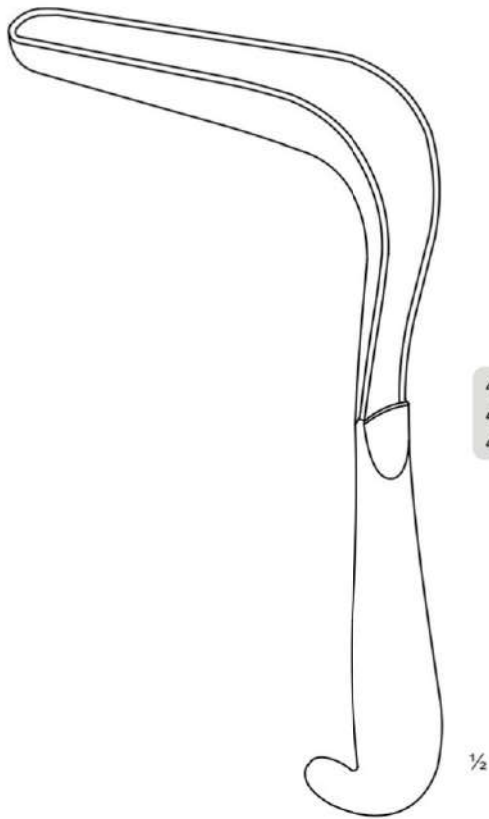

45-1001	110 x 20mm
45-1002	110 x 30mm
45-1003	110 x 36mm

KRISTELLER

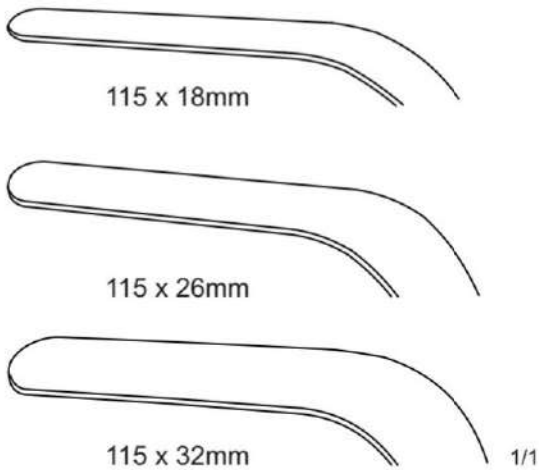

45-1101	115 x 18mm
45-1102	115 x 26mm
45-1103	115 x 32mm

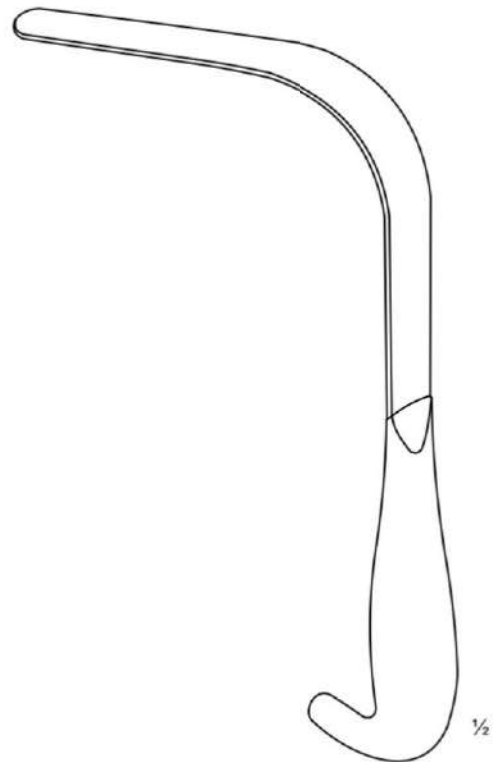

KRISTELLER

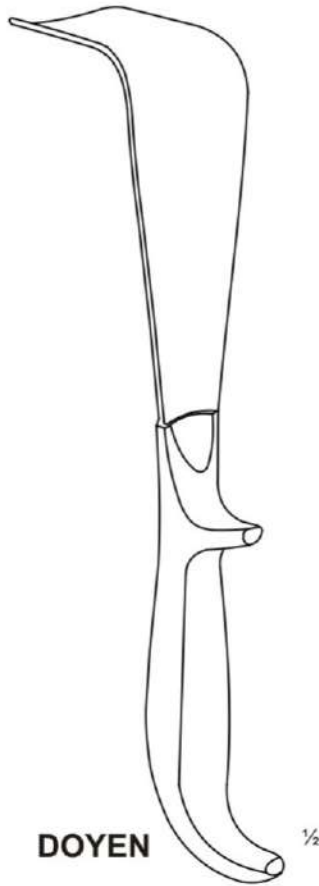

DOYEN

½

▶ 45-1201	55 x 35mm
45-1202	55 x 45mm
45-1203	55 x 60mm

1/1

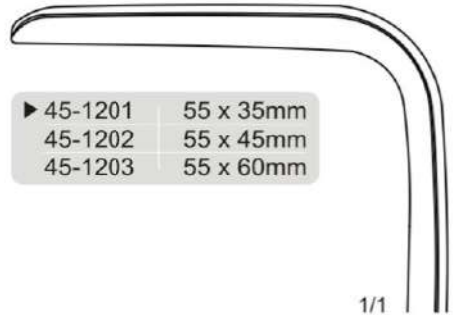

45-1204	85 x 35mm
45-1205	85 x 45mm
▶ 45-1206	85 x 60mm

1/1

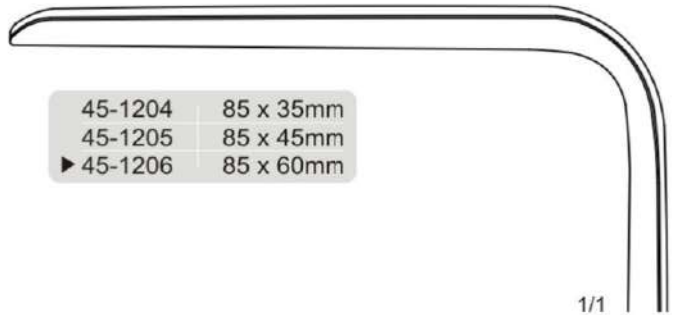

45-1207	115 x 35mm
45-1208	115 x 45mm
45-1209	115 x 60mm

1/1

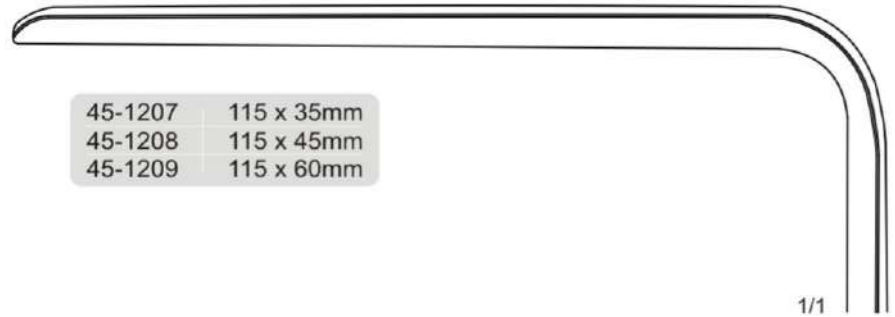

45-1210	160 x 45mm
45-1211	160 x 60mm

1/1

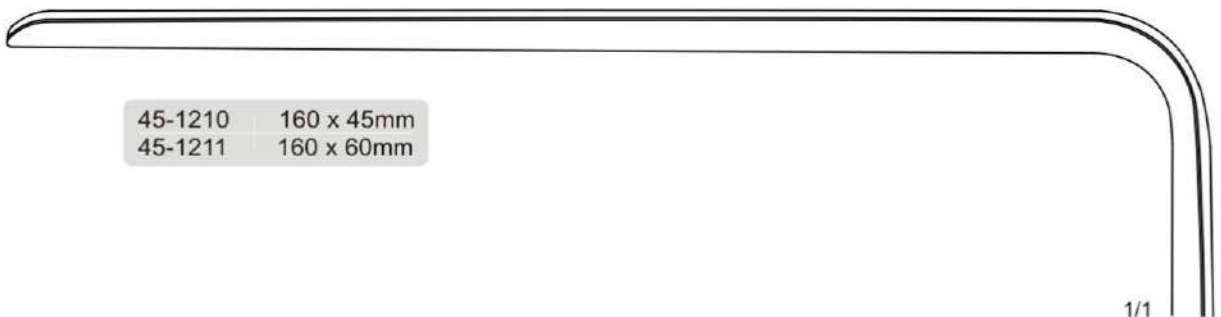

# Vaginal Retractors

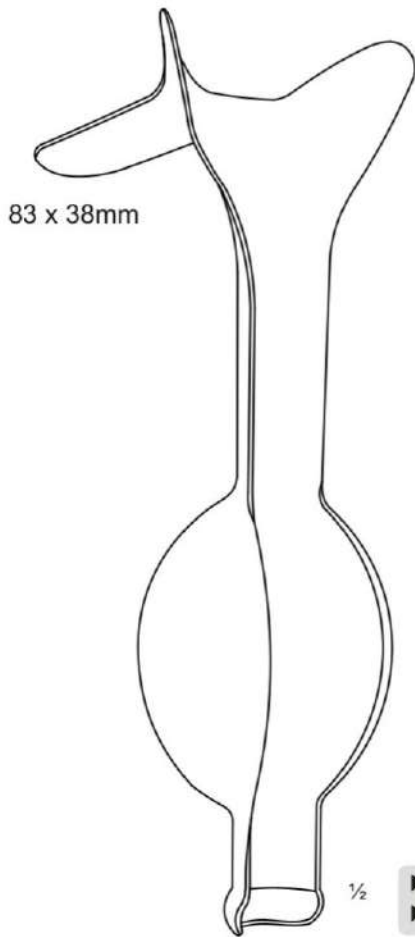

**AUVARD**

▶ 45-1301	1.14kg
▶ 45-1302	1.36kg

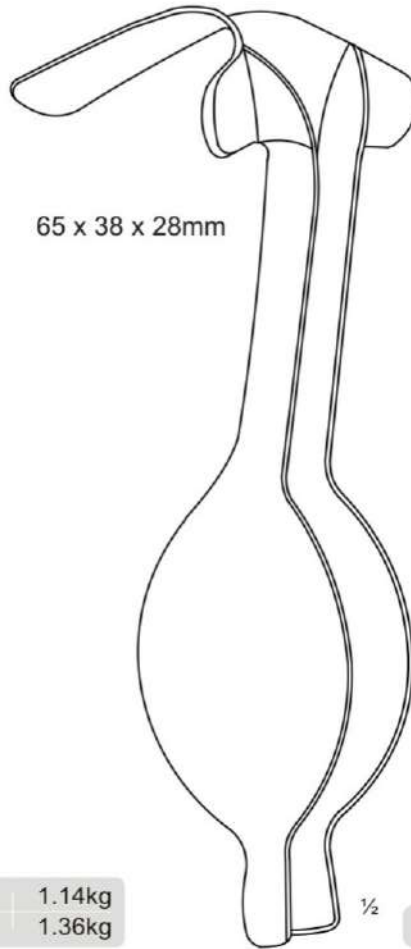

**AUVARD**

45-1400	1.53kg
---------	--------

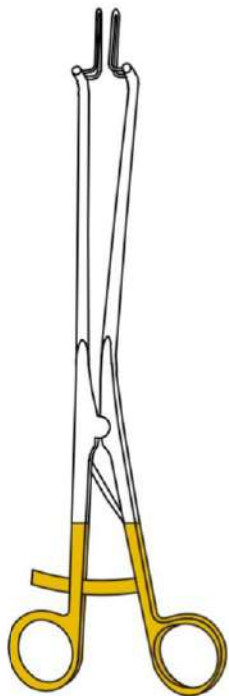

**KOGAN**  
Endocervical  
Speculum

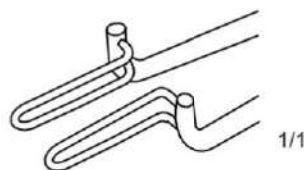

**STANDARD BLADES**

45-1501	28cm	with lock
45-1503	28cm	with lock, angled shaft
45-1510	28cm	without lock
45-1511	24cm	with screw

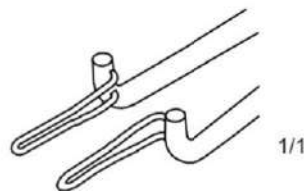

**NARROW BLADES**

45-1502	28cm	with lock
45-1512	24cm	with screw



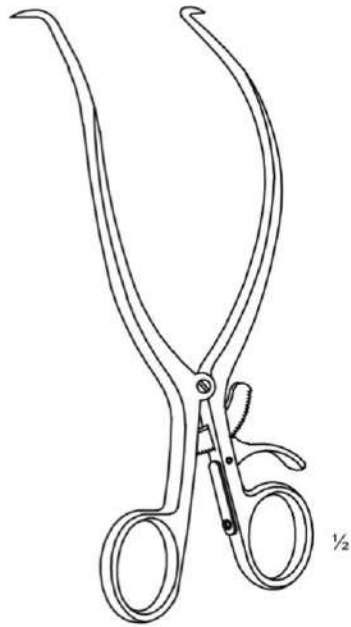

**GELPI**

- ▶ 16-2401 13.0cm
- ▶ 16-2402 19.0cm

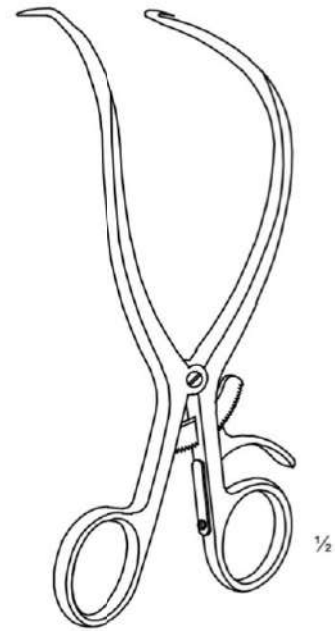

**GELPI-LOKTITE**

- ▶ 16-2501 16.0cm
- ▶ 16-2502 17.5cm

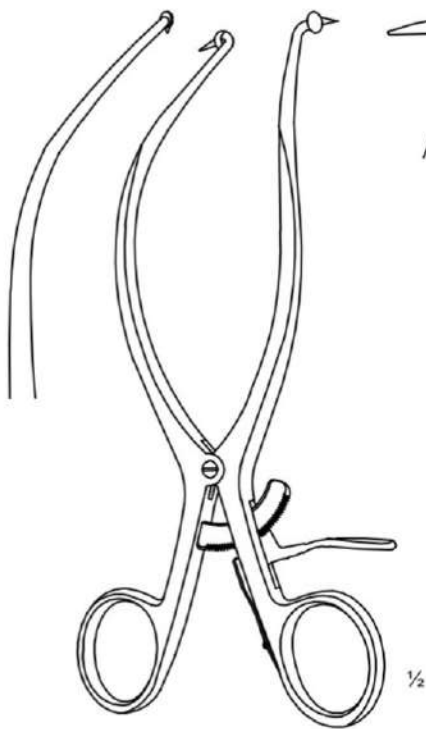

**GELPI**

- ▶ 16-2401 13.0cm
- ▶ 16-2402 19.0cm

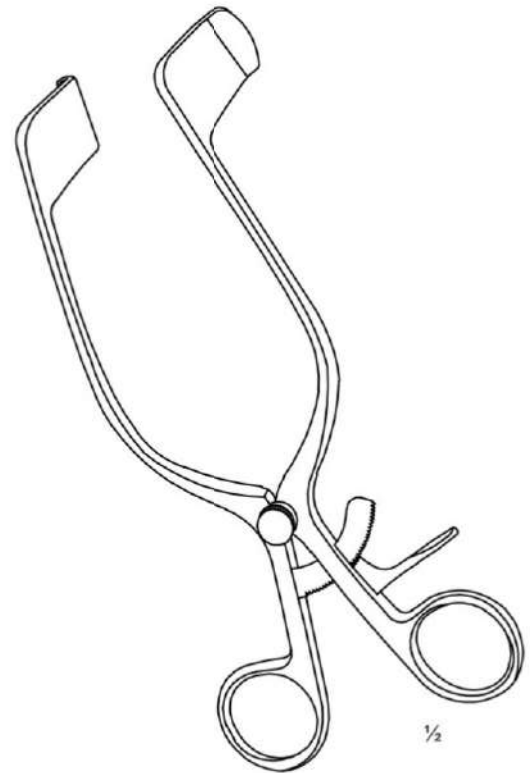

**RIGBY**

- ▶ 15-1600 18.0cm

# Hegars



## HEGAR

- ▶ 45-1700A #1-13 set
- ▶ 45-1700B #14-20 set

▶ 45-1701	#1	▶ 45-1711	#11
▶ 45-1702	#2	▶ 45-1712	#12
▶ 45-1703	#3	▶ 45-1713	#13
▶ 45-1704	#4	▶ 45-1714	#14
▶ 45-1705	#5	▶ 45-1715	#15
▶ 45-1706	#6	▶ 45-1716	#16
▶ 45-1707	#7	▶ 45-1717	#17
▶ 45-1708	#8	▶ 45-1718	#18
▶ 45-1709	#9	▶ 45-1719	#19
▶ 45-1710	#10	▶ 45-1720	#20



## HEGAR Double Ended

45-1800	SET
45-1801	1+2mm
45-1802	3+4mm
45-1803	5+6mm
45-1804	7+8mm
45-1805	9+10mm
45-1806	11+12mm
45-1807	13+14mm
45-1808	15+16mm
45-1809	17+18mm

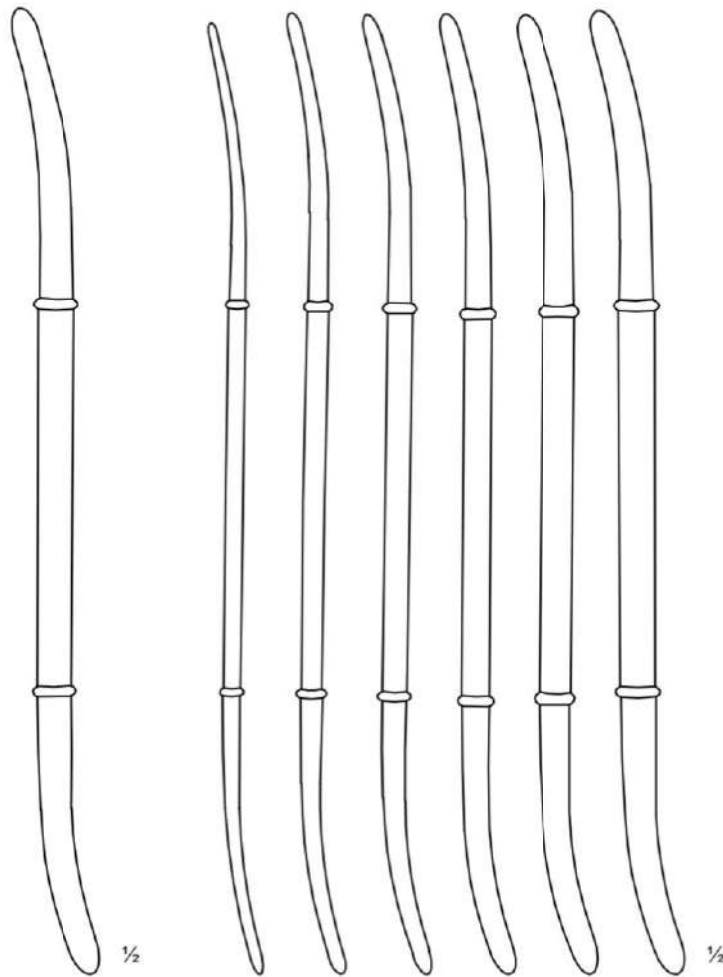

## HANK Double Ended

45-1900	SET
45-1901	4.5 / 5mm 9/10
45-1902	5.5 / 6mm 11/12
45-1903	6.5 / 7mm 13/14
45-1904	7.5 / 8mm 15/16
45-1905	8.5 / 9mm 17/18
45-1906	9.5 / 10mm 19/20

∅ 4.0mm

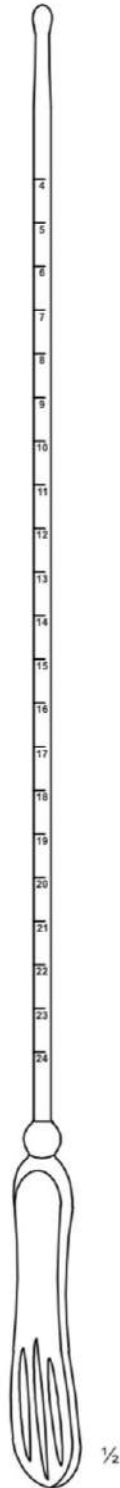

Maleable

45-2001 34.0mm

∅ 5.0mm

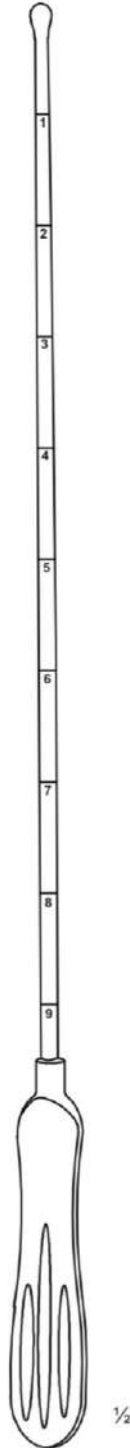

**MAYO**  
Maleable

45-2002 32.0mm

∅ 2.5mm

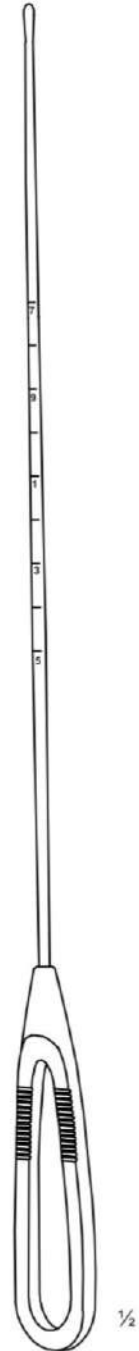

Maleable

▶ 45-2003 31.0mm

**Uterine Hooks**



**EMMEIT**

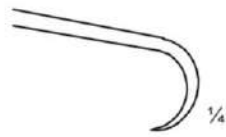

**FULL CURVED**

- ▶ 45-2101 Flat Handle
- ▶ 45-2110 Round Handle



**ACUTE CURVED**

- ▶ 45-2102 Flat Handle
- ▶ 45-2120 Round Handle



**RIGHT ANGLED**

- ▶ 45-2103 Flat Handle
- ▶ 45-2130 Round Handle



**DOUBLE ANGLED**

- ▶ 45-2104 Flat Handle
- ▶ 45-2140 Round Handle



**CURVED**

- ▶ 45-2105 Flat Handle
- ▶ 45-2150 Round Handle



**IRIS DELICATE**

- ▶ 45-2106 Flat Handle
- ▶ 45-2160 Round Handle

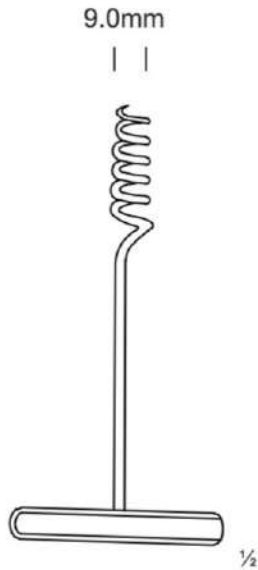

**DOYEN**  
Mayoma Screw

- ▶ 45-2200 9mm 17.5cm



**BEACHAM**  
Amniotome

- ▶ 45-2300 26.0cm

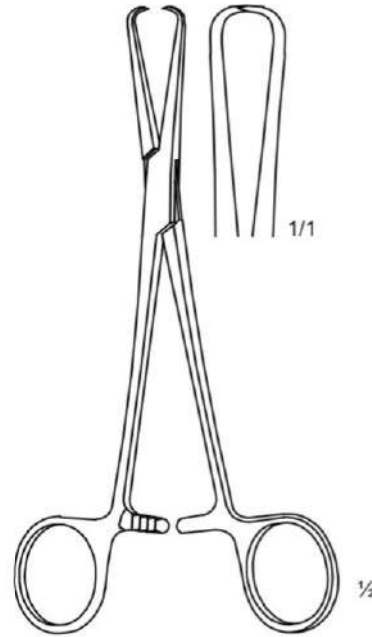

**POZZI**

45-2400 17.5cm

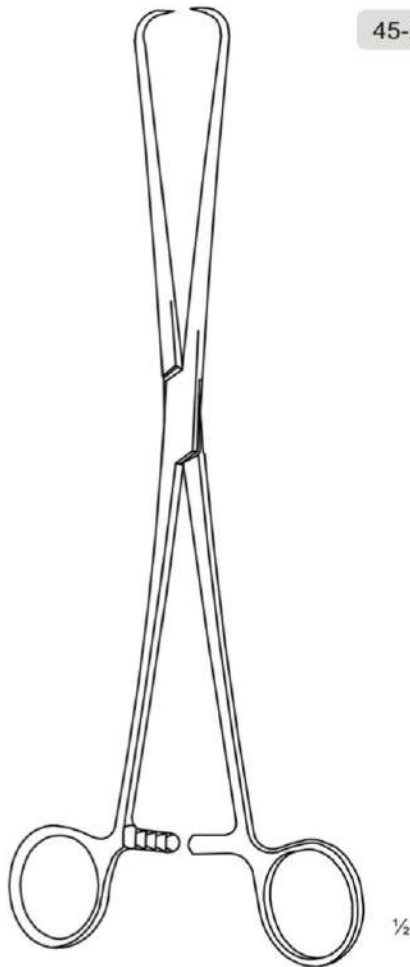

**SCHROEDER**

1 x 1 teeth

► 45-2501 23.0cm Straight

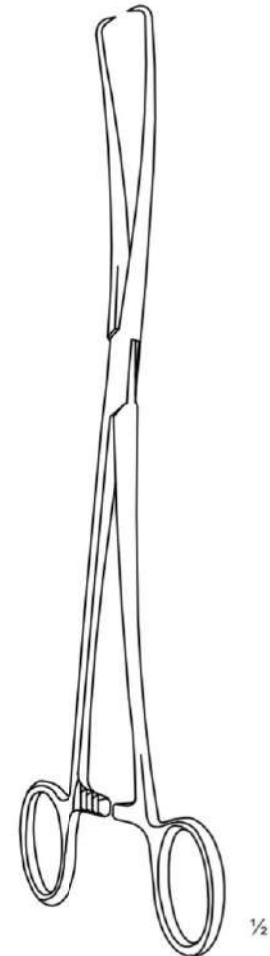

**SCHROEDER**

1 x 1 teeth

► 45-2511 23.0cm Curved

# Tenaculum Forceps

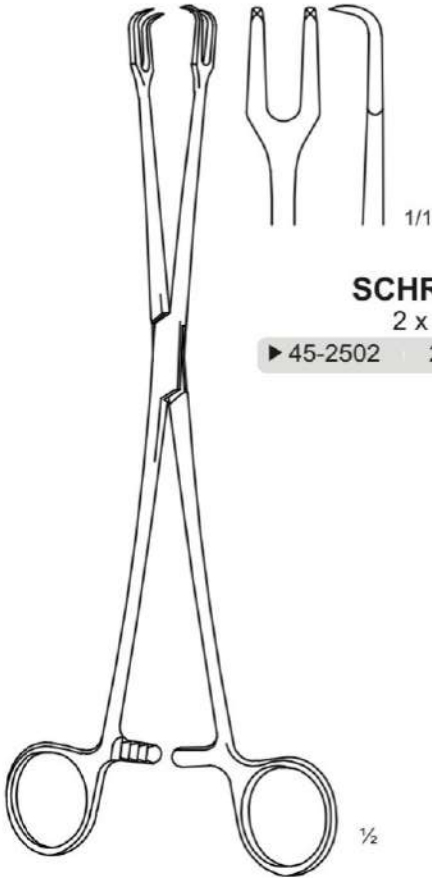

**SCHROEDER**  
2 x 2 teeth

▶ 45-2502 24.0cm Straight

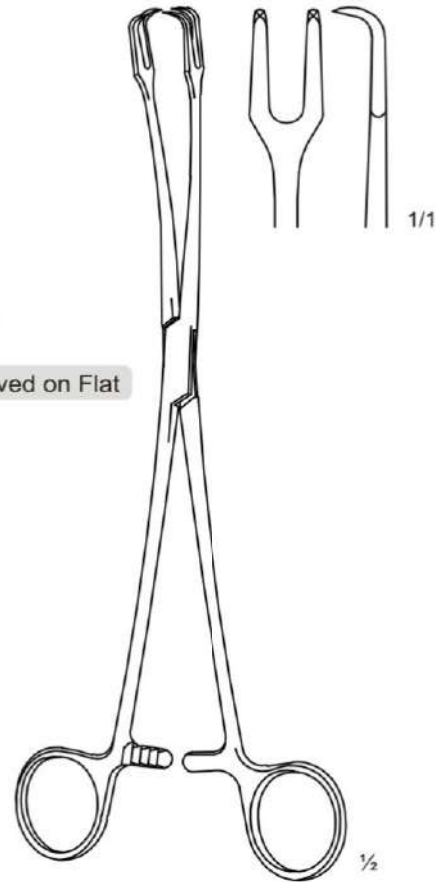

**SCHROEDER**  
2 x 2 teeth

▶ 45-2512 24.0cm Curved on Flat

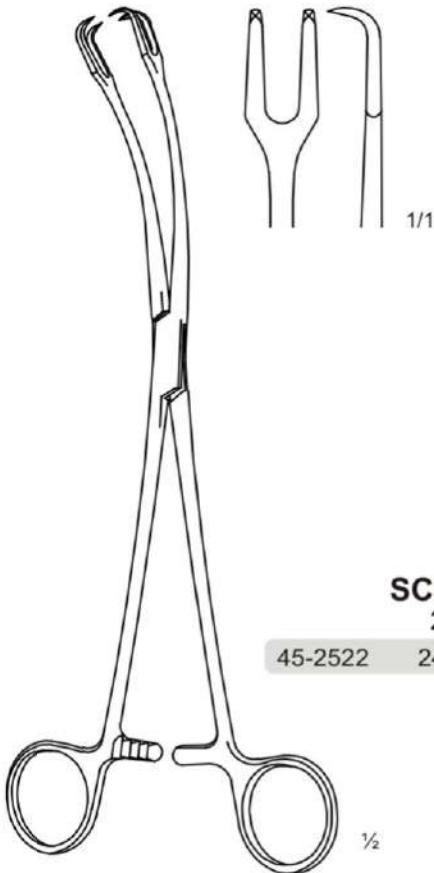

**SCHROEDER**  
2 x 2 teeth

▶ 45-2522 24.0cm Curved to Side



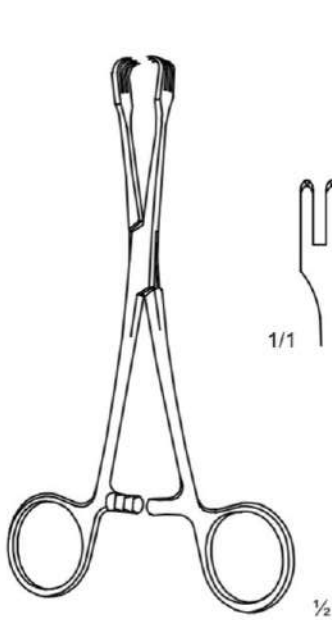

**LAHEY**

43-0810	15.0cm	3 x 3 teeth
43-0820	20.0cm	3 x 3 teeth

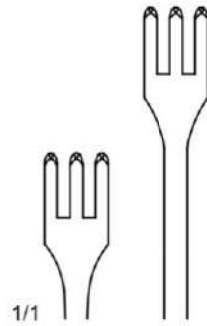

**STAUDE-MOORE**

45-2600	17.0cm
---------	--------

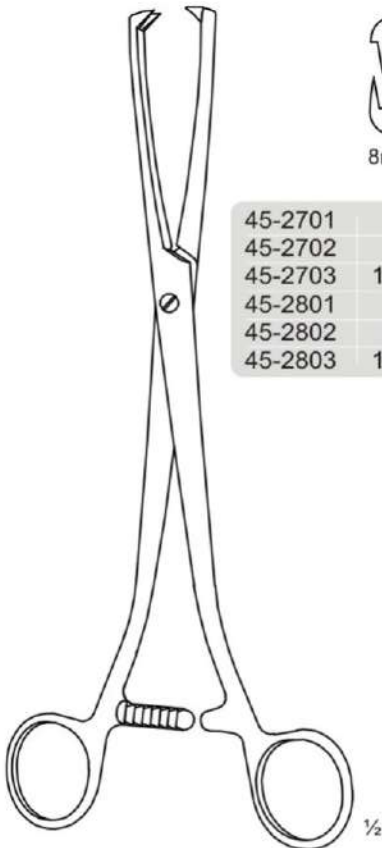
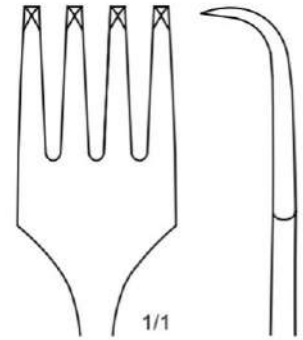

**MUSEUX**  
Straight

45-2701	6mm	Straight
45-2702	8mm	Straight
45-2703	10mm	Straight
45-2801	6mm	Curved
45-2802	8mm	Curved
45-2803	10mm	Curved

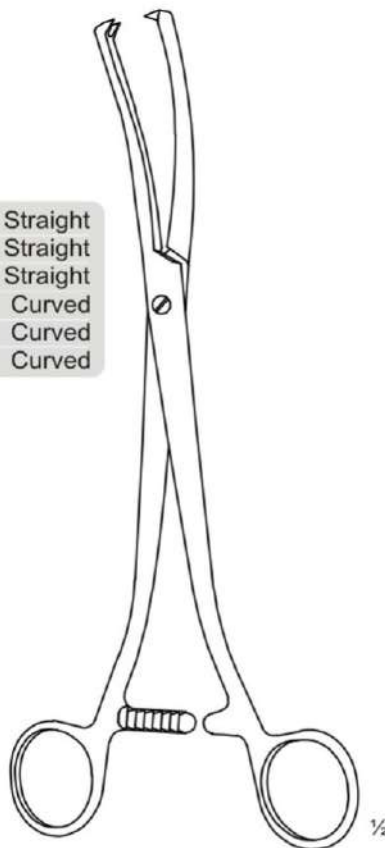

**MUSEUX**  
Curved

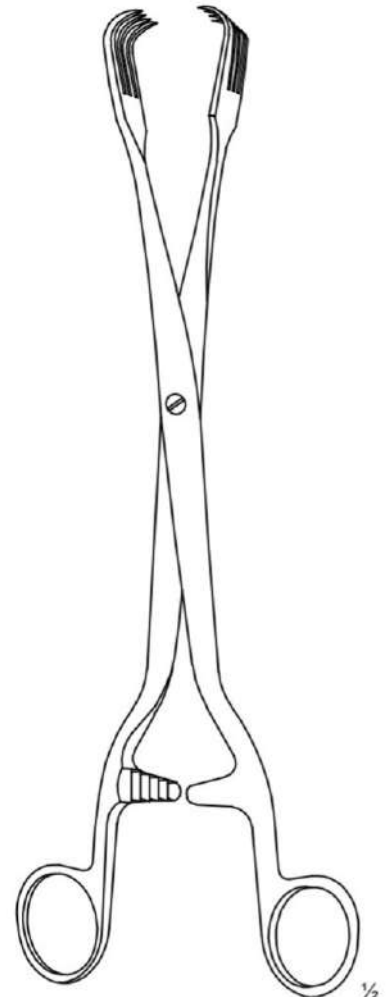

**PRATT**

45-2900	28.0cm
---------	--------

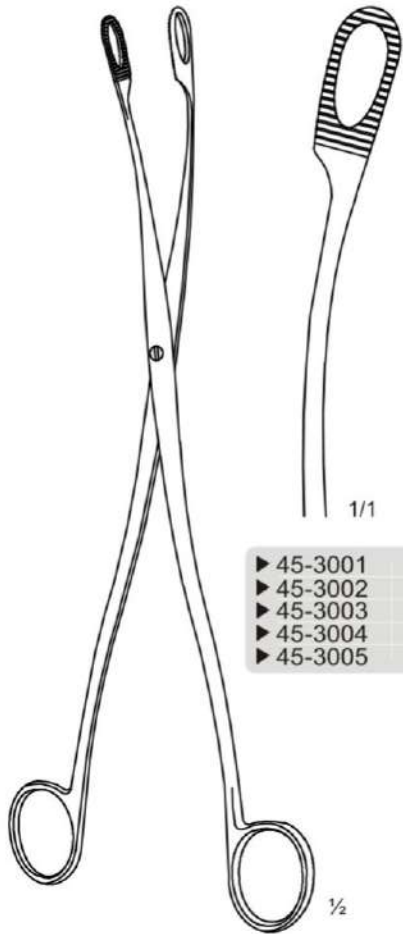

- ▶ 45-3001 4.5mm
- ▶ 45-3002 6.0mm
- ▶ 45-3003 9.0mm
- ▶ 45-3004 12.0mm
- ▶ 45-3005 15.0mm

PLACENTA FORCEPS

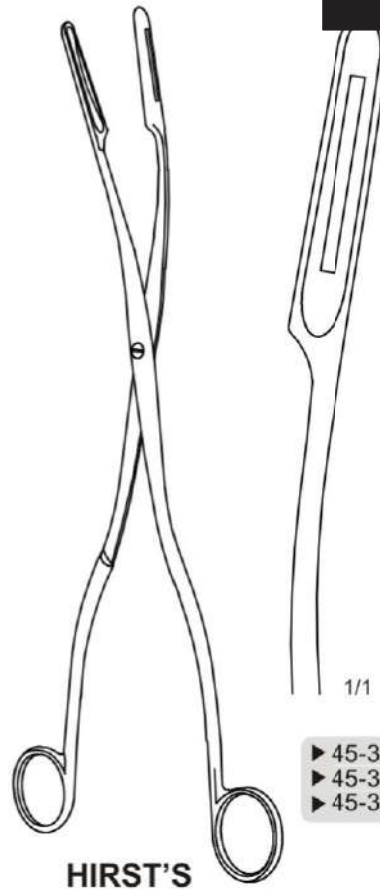

- ▶ 45-3101 Small
- ▶ 45-3102 Medium
- ▶ 45-3103 Large

HIRST'S

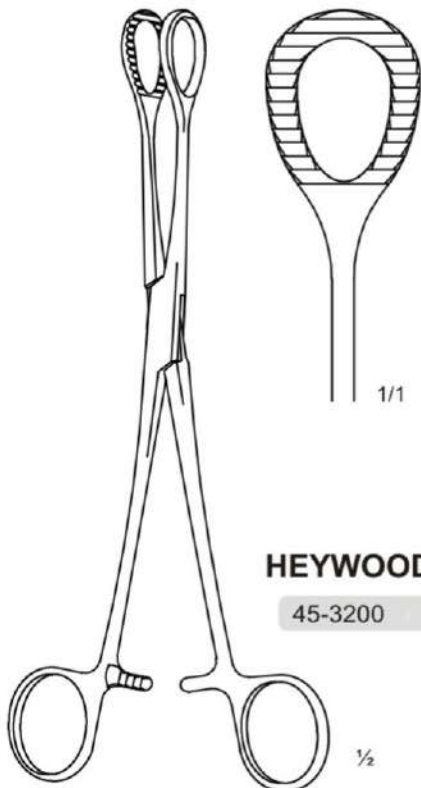

HEYWOOD-SMITH

- ▶ 45-3200 25.0cm

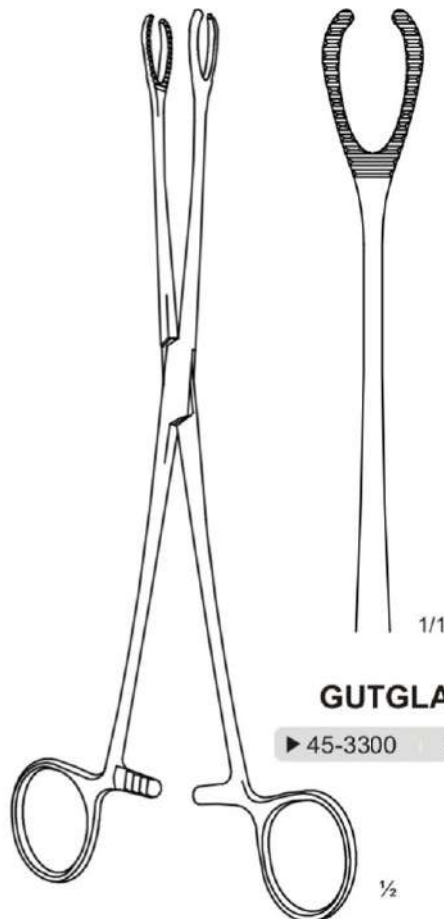

GUTGLASS

- ▶ 45-3300 23.0cm

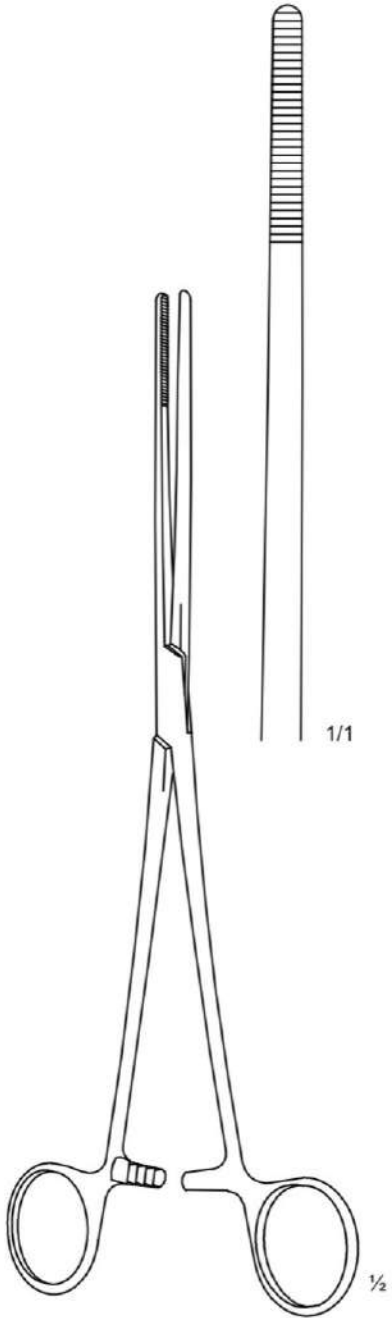

**BOZEMANN**

▶ 45-3401 26.0cm Straight

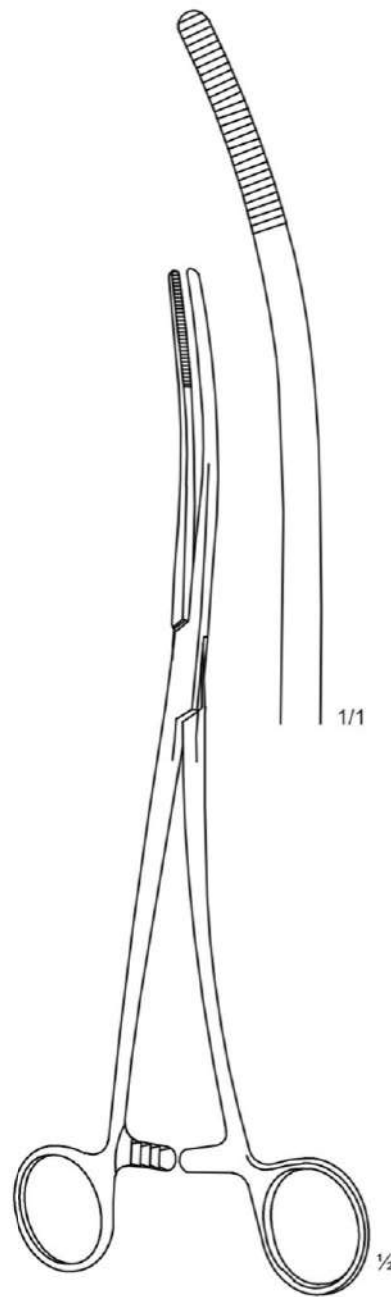

**BOZEMANN**

▶ 45-3411 26.0cm Curved

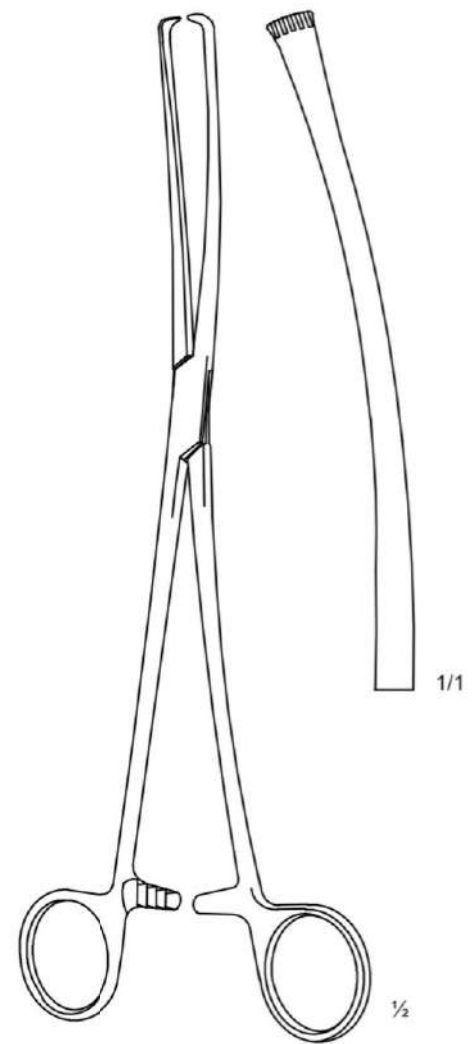

**IOWA**  
Membrane Puncturing Forceps  
5 x 6 teeth

▶ 45-3500 26.0cm

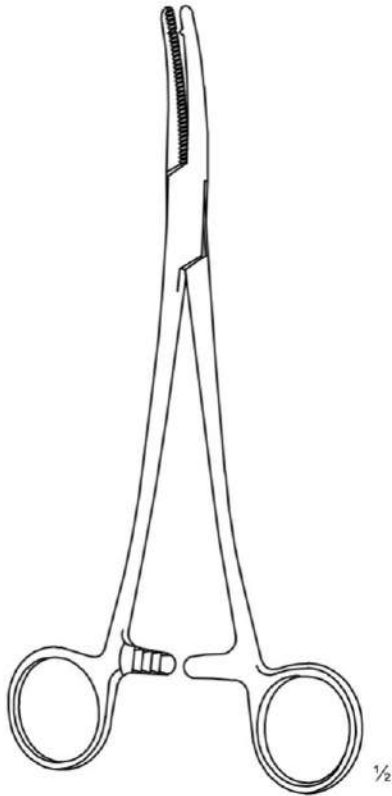

HEANEY

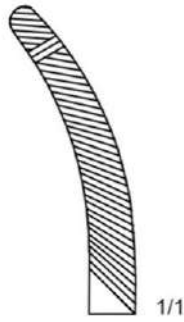

- ▶ 45-3611 21.0cm 1 tooth
- ▶ 45-3612 23.0cm 1 tooth
- ▶ 45-3613 25.0cm 1 tooth

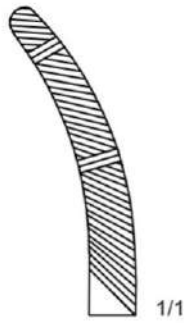

- ▶ 45-3621 21.0cm 2 teeth
- ▶ 45-3622 23.0cm 2 teeth
- ▶ 45-3623 25.0cm 2 teeth

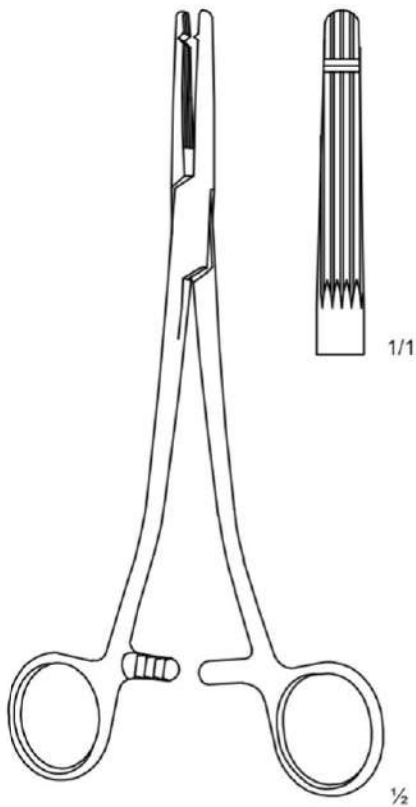

HEANEY-BALLANTINE

- ▶ 45-3701 20.4cm Straight

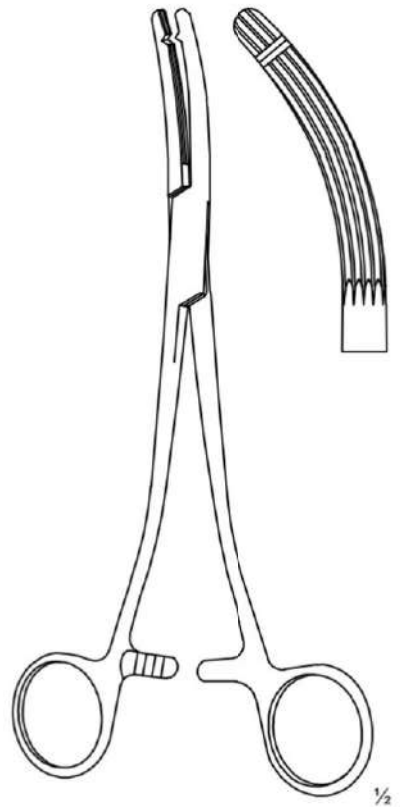
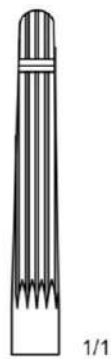

HEANEY-BALLANTINE

- ▶ 45-3711 20.4cm Curved



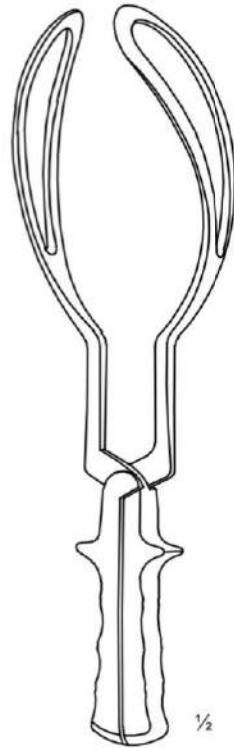

**SIMPSON**  
Obstetrical Forceps  
▶ 45-3800 30.0cm

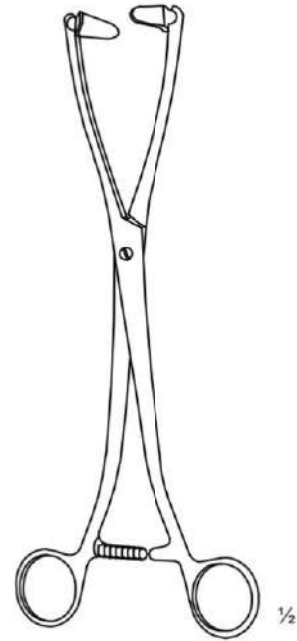

**COLLIN**  
Uterine Elevating Forceps  
▶ 45-4000 26.5cm

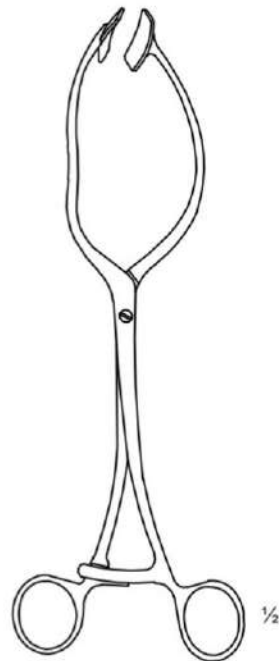

**KIM'S**  
Uterine Elevating Forceps  
▶ 45-4001 27.0cm

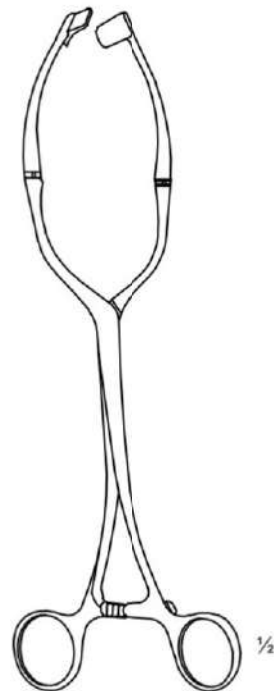

**NEW-KIM'S**  
Uterine Elevating Forceps  
▶ 45-4002 29.5cm



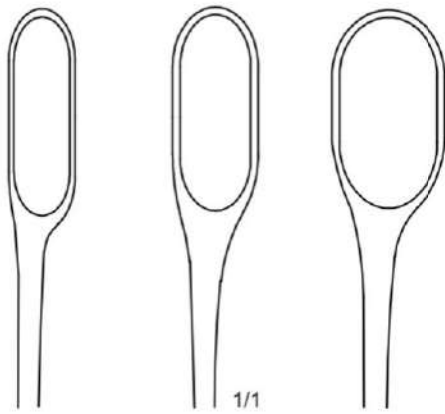

1/1

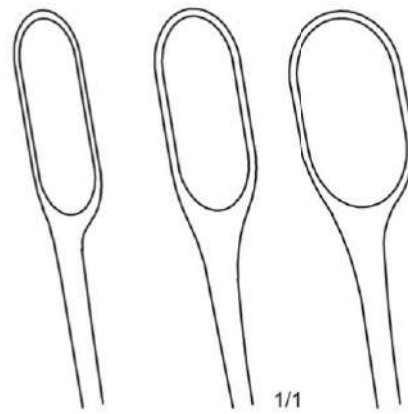

1/1

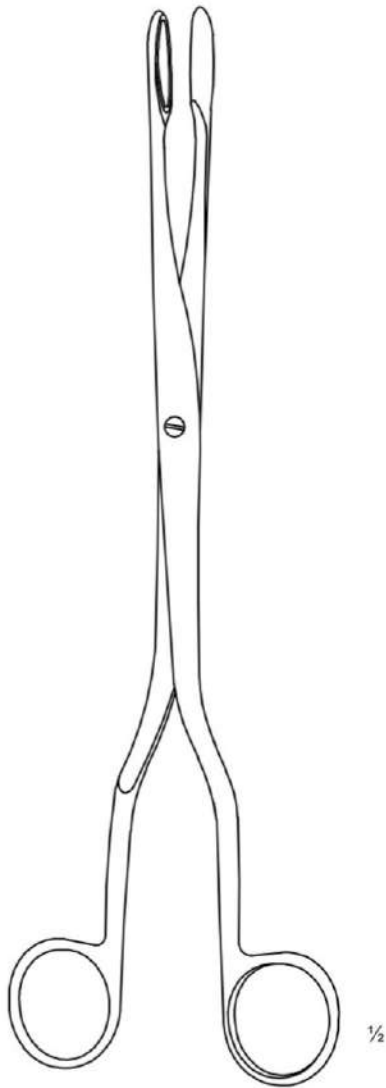

1/2

**WINTER**

without ratchet		with ratchet	
45-4101	Straight		
45-4102	Straight	45-4202	Straight
45-4103	Straight	45-4203	Straight

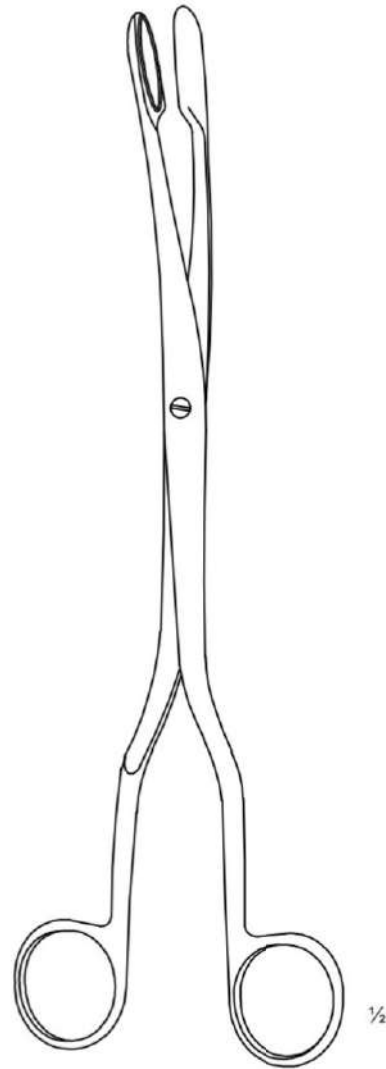

1/2

**WINTER**

without ratchet		with ratchet	
45-4111	Curved		
45-4112	Curved	45-4212	Curved
45-4113	Curved	45-4213	Curved



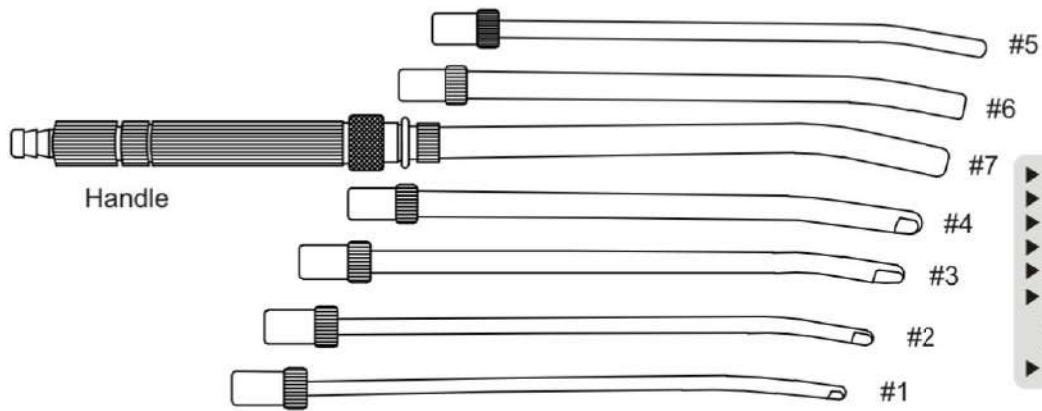

▶ 45-4300	SET
▶ 45-4301	#1
▶ 45-4302	#2
▶ 45-4303	#3
▶ 45-4304	#4
▶ 45-4305	#5
▶ 45-4306	#6
▶ 45-4307	#7
▶ 45-4310	Handle

**CANNULA FOR ABORTION**



**DOO'S PELVIC**

▶ 45-4400	40.0cm
-----------	--------

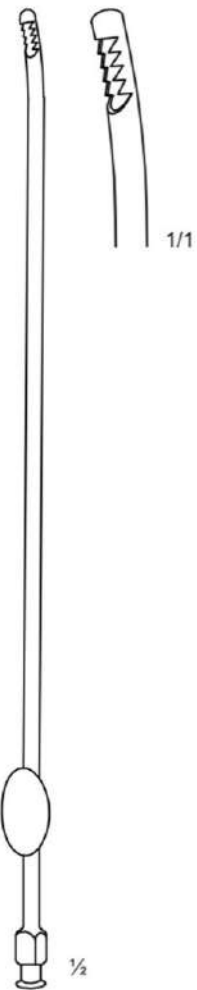

**NOVAK**

45-4501	1mm
45-4502	2mm
45-4503	3mm
45-4504	4mm
45-4512	hoffmeister 2mm

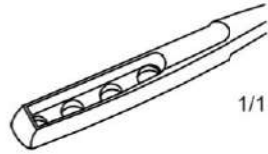

**KEVORKIAN**

- 45-4601 Rigid shaft
- 45-4602 Malleable shaft
- 45-4603 Mini-head

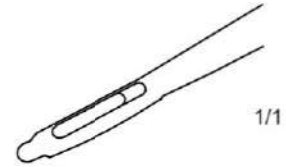

**MINI-KEVORKIAN**

- 45-4701 Rigid shaft
- 45-4702 Malleable shaft



**KEVORKIAN**

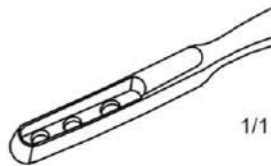

**DUNCAN**

- 45-4801 with basket
- 45-4802 without basket

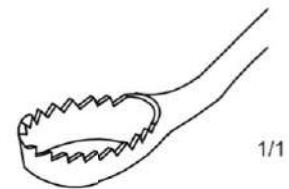

**HEANEY**

- 45-4803 with basket
- 45-4804 without basket



½

**SIMS**  
Malleable

45-5100	#0	Sharp
45-5101	#1	Sharp
45-5102	#2	Sharp
45-5103	#3	Sharp
45-5104	#4	Sharp
45-5105	#5	Sharp
45-5106	#6	Sharp
45-5107	#7	Sharp
45-5108	#8	Sharp
45-5109	#9	Sharp
45-5110	#10	Sharp

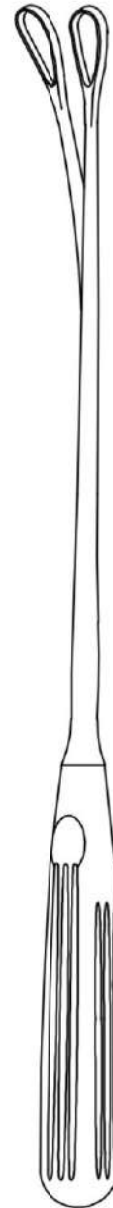

½

**SIMS**  
Malleable

45-5200	#0	Blunt
45-5201	#1	Blunt
45-5202	#2	Blunt
45-5203	#3	Blunt
45-5204	#4	Blunt
45-5205	#5	Blunt
45-5206	#6	Blunt
45-5207	#7	Blunt
45-5208	#8	Blunt
45-5209	#9	Blunt
45-5210	#10	Blunt

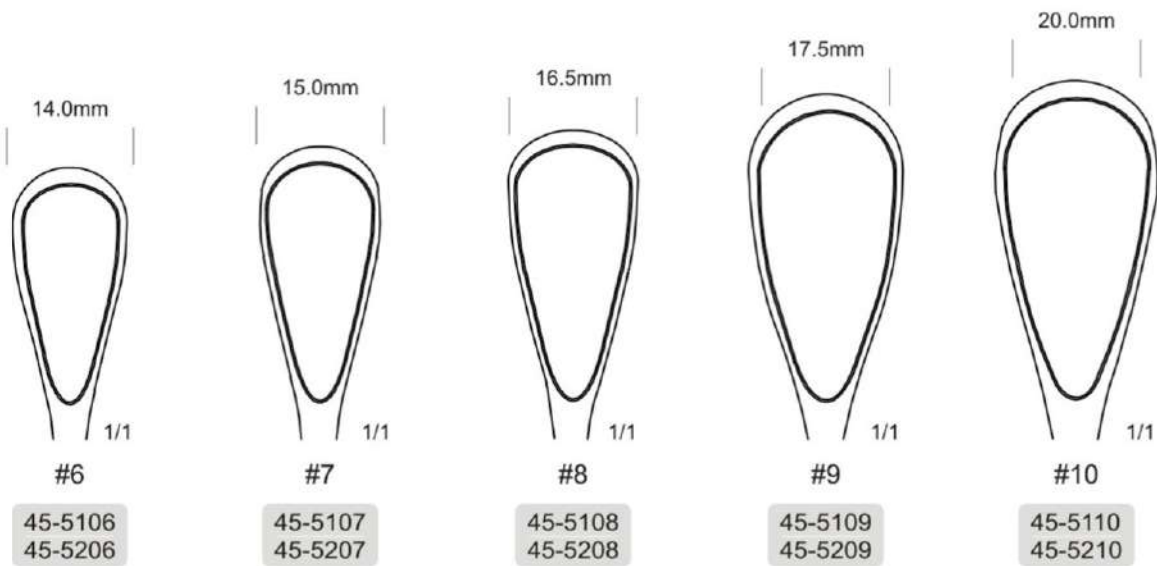
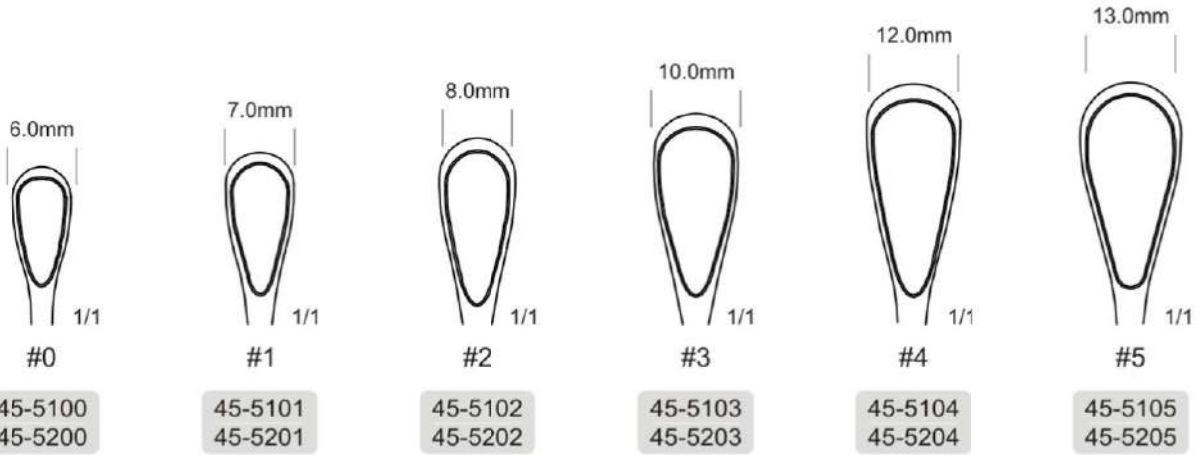

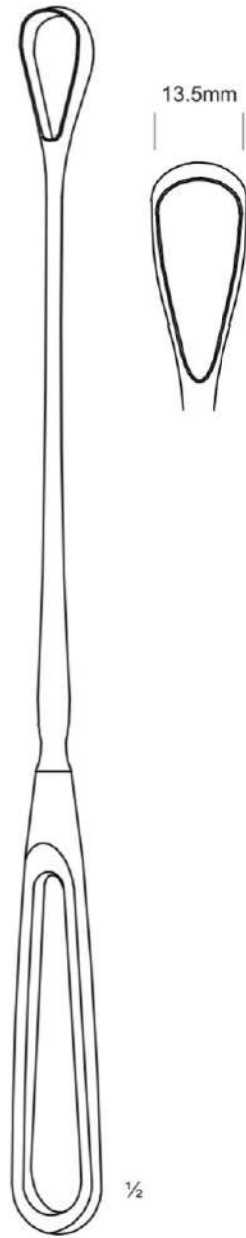

**SIMS**

▶ 45-4900	5.5mm	#0
▶ 45-4901	7.0mm	#1
▶ 45-4902	8.5mm	#2
▶ 45-4903	10.0mm	#3
▶ 45-4904	11.5mm	#4
▶ 45-4905	13.5mm	#5
▶ 45-4906	17.0mm	#6
▶ 45-4907	20.0mm	#7
▶ 45-4908	24.0mm	#8
▶ 45-4909	28.0mm	#9

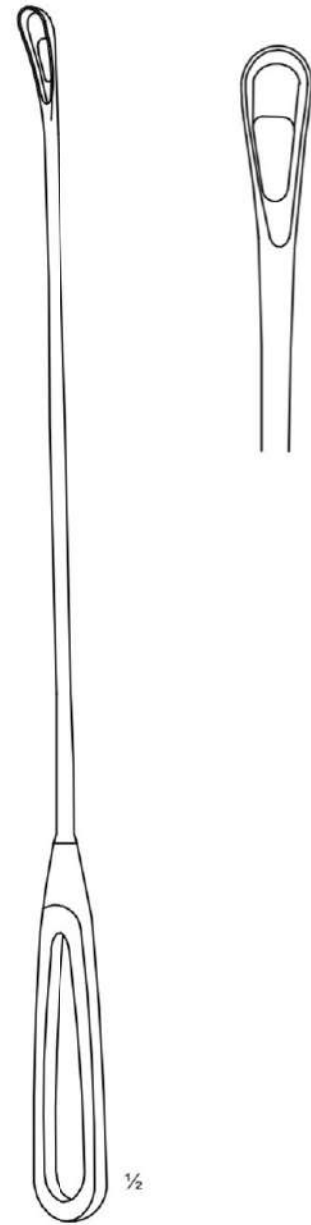

**J.O.M.W**

▶ 45-5301	4.5mm	#1
▶ 45-5302	6.0mm	#2
▶ 45-5303	7.5mm	#3
▶ 45-5304	9.0mm	#4
▶ 45-5305	12.0mm	#5
▶ 45-5306	15.0mm	#6

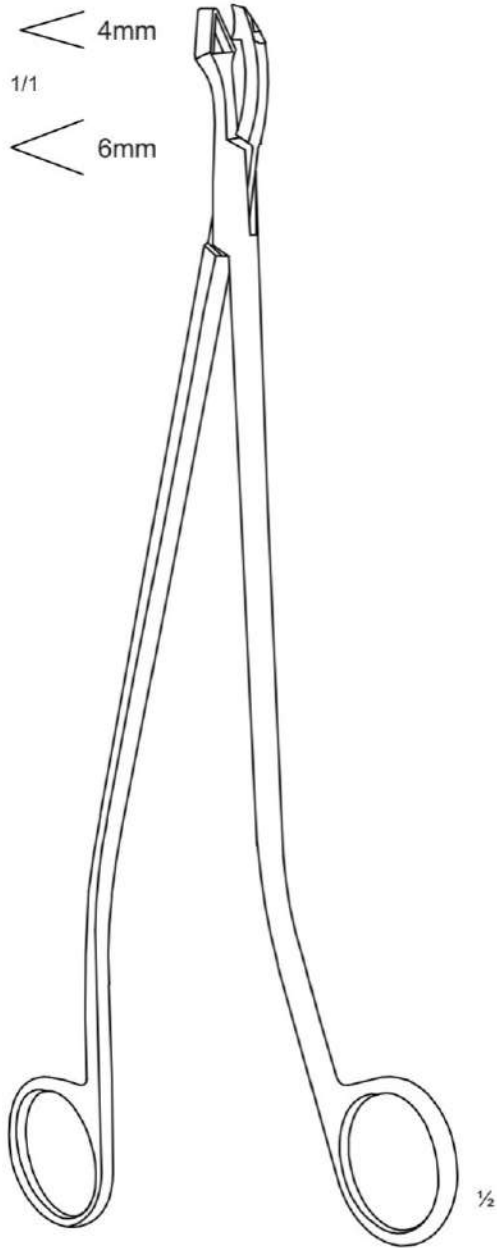

**SCHUMACHER**

45-5401 4mm  
45-5402 6mm

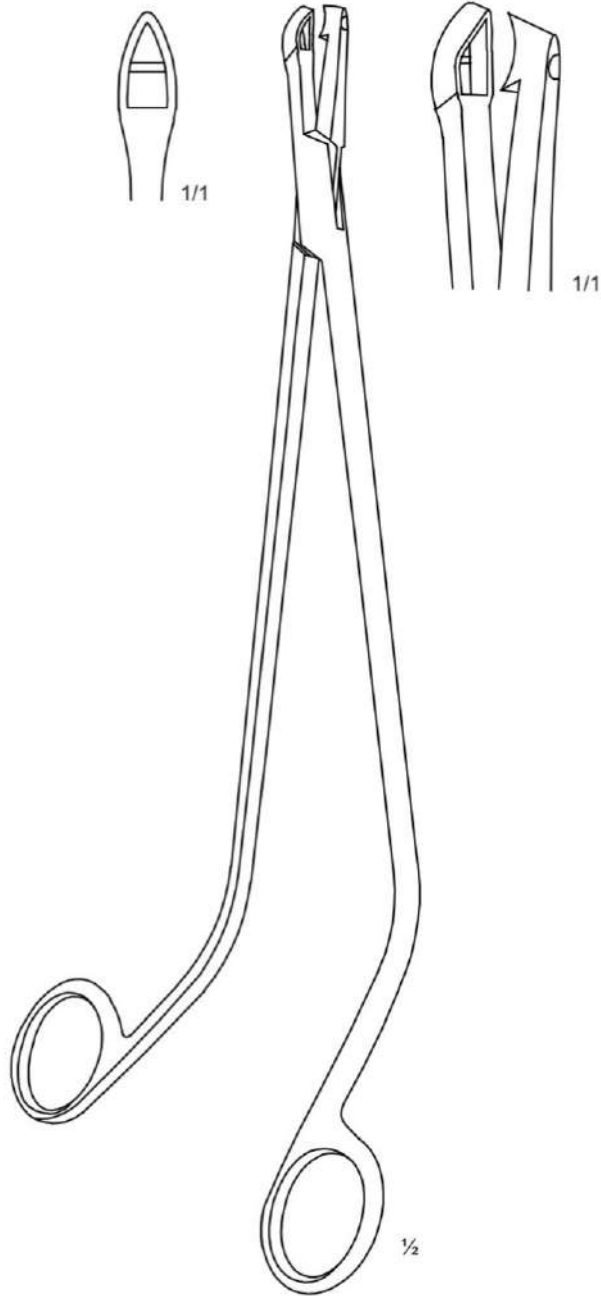

**TISCHLER**

45-5500 26.0cm



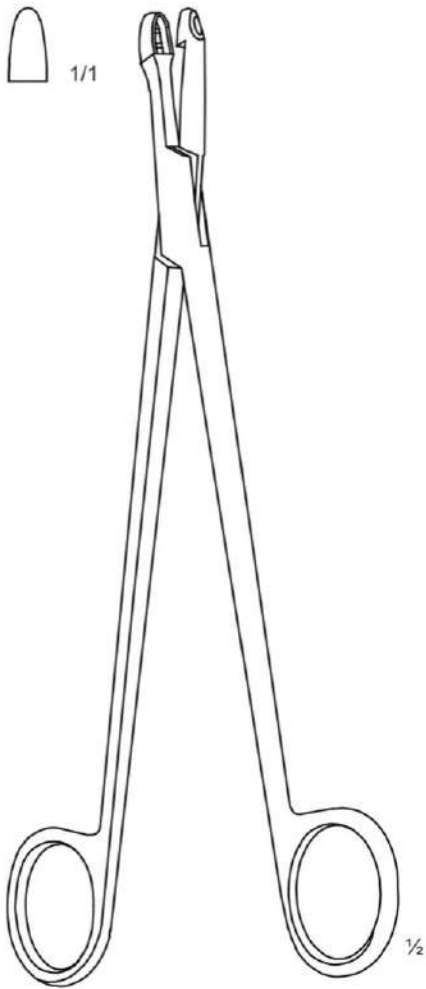

**SCHUBERT**

45-5601	21.0cm	Straight
45-5602	29.0cm	Straight

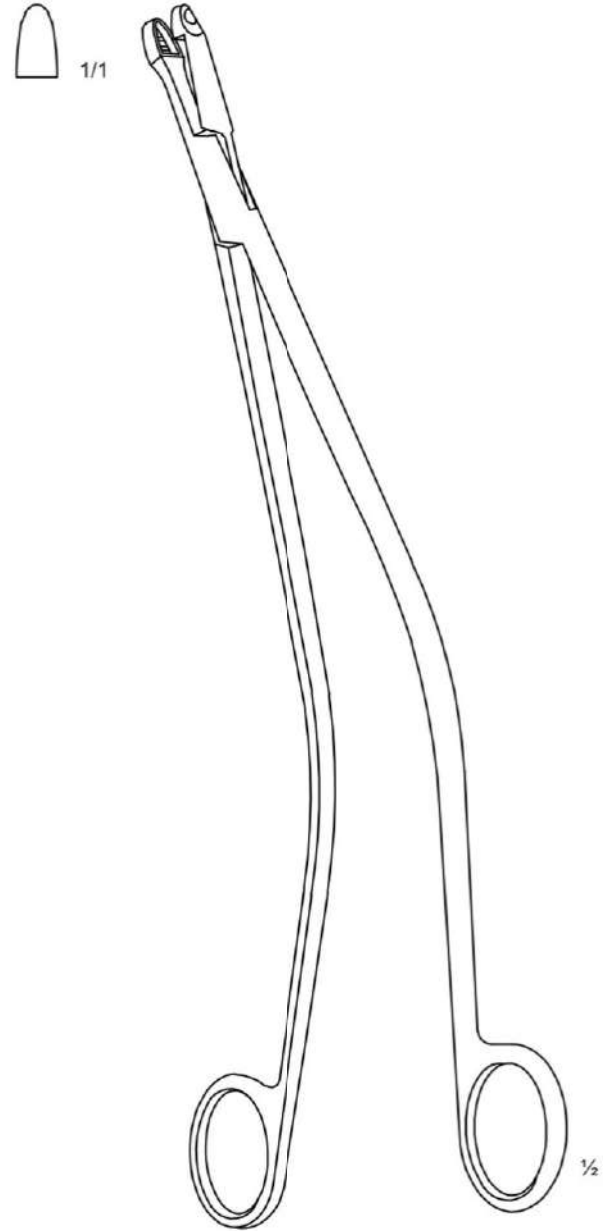

**SCHUBERT**

45-5610	26.0cm	Curved
---------	--------	--------

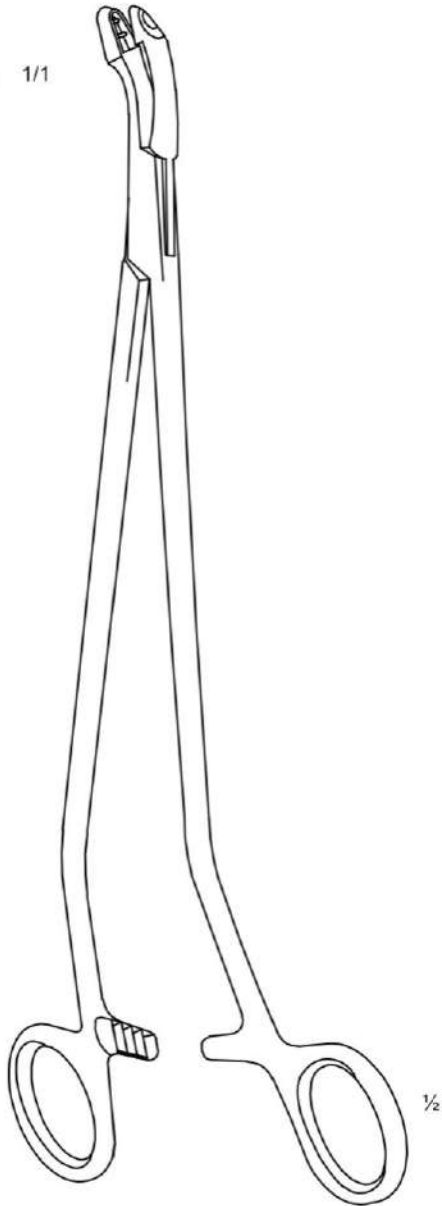
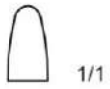

**VAN DOREN**  
with ratchet  
45-5701 26.0cm

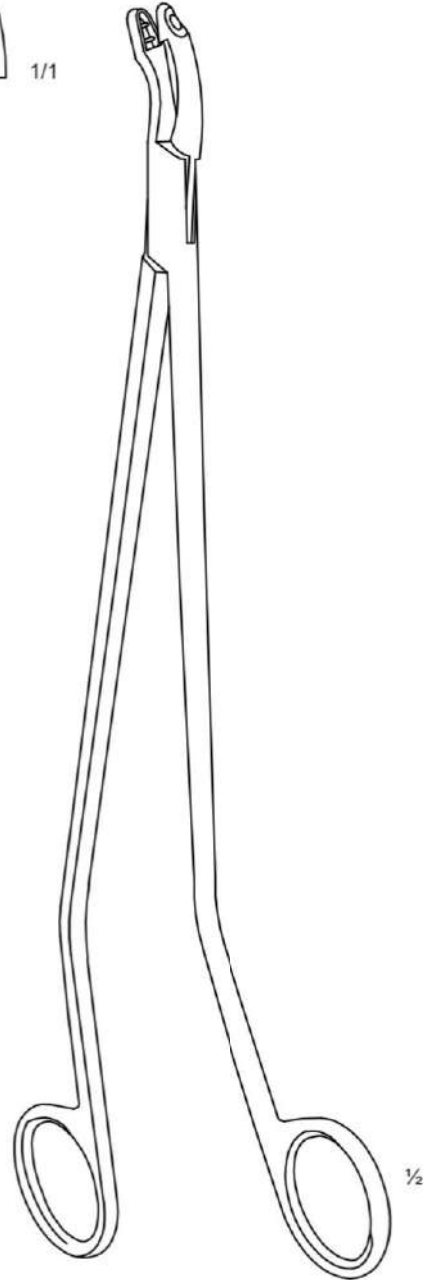
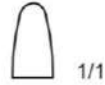

**VAN DOREN**  
without ratchet  
45-5702 28.0cm

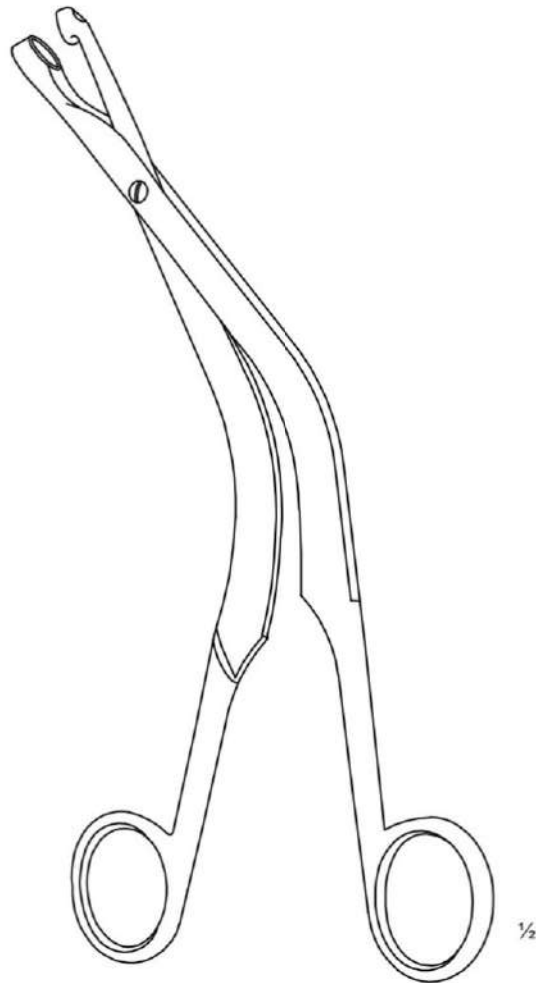
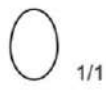

**FAURE**

45-5800 23.0cm

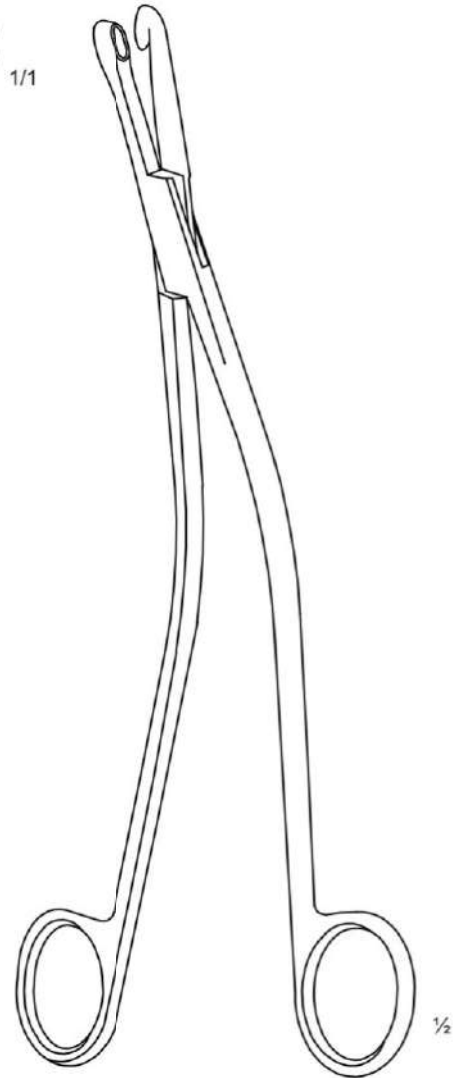

**GELLHORN**

45-5900 23.0cm

# Cervical Biopsy Forceps

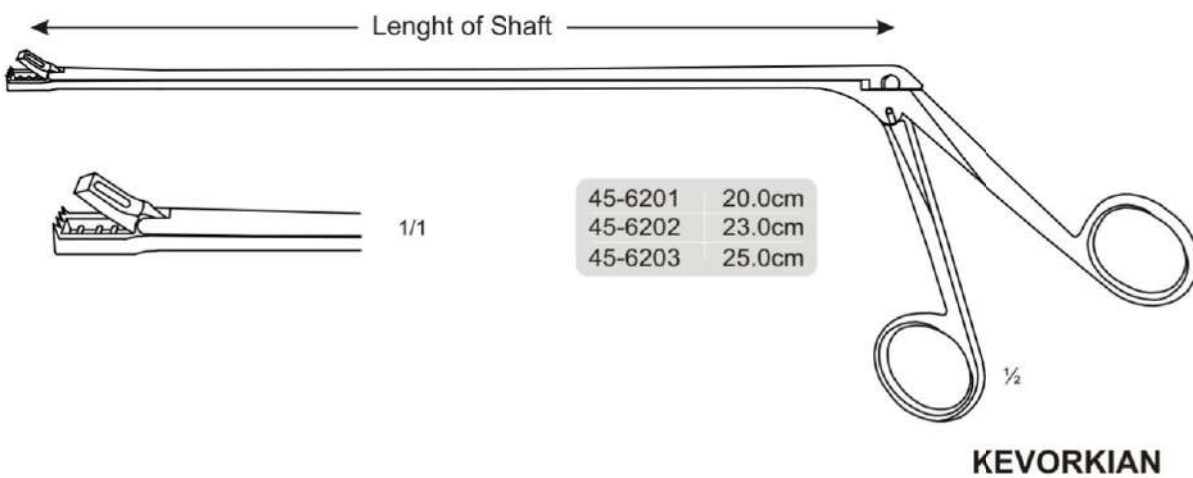
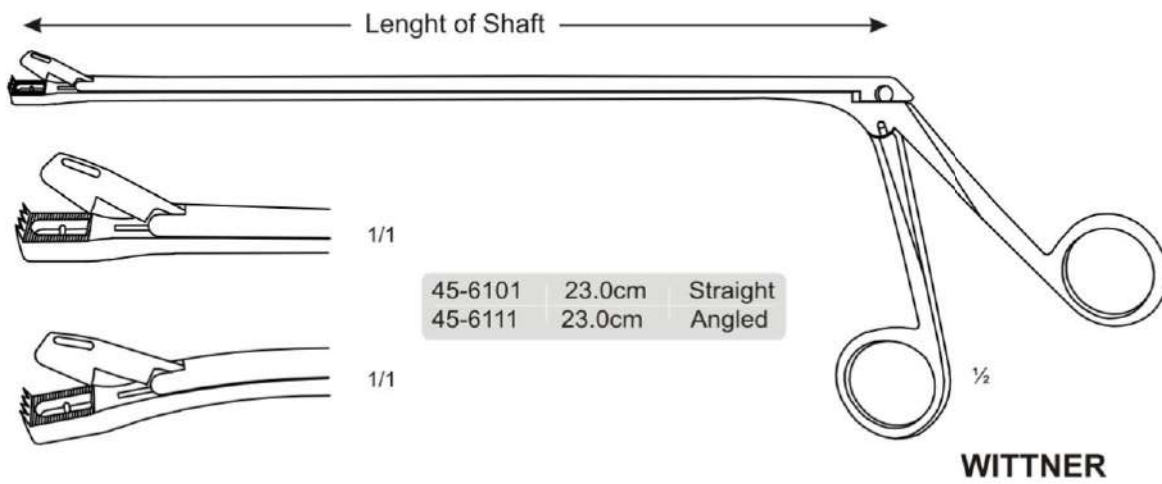
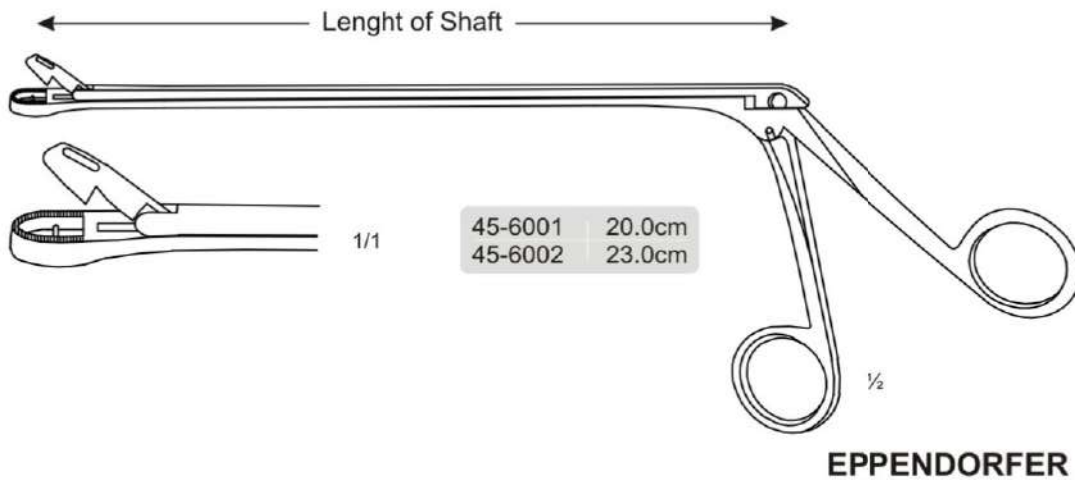

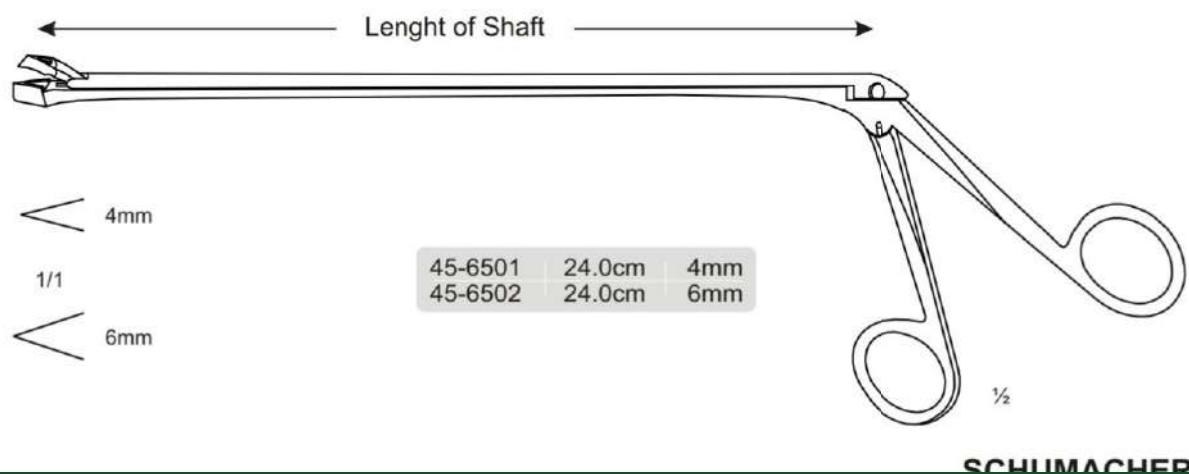
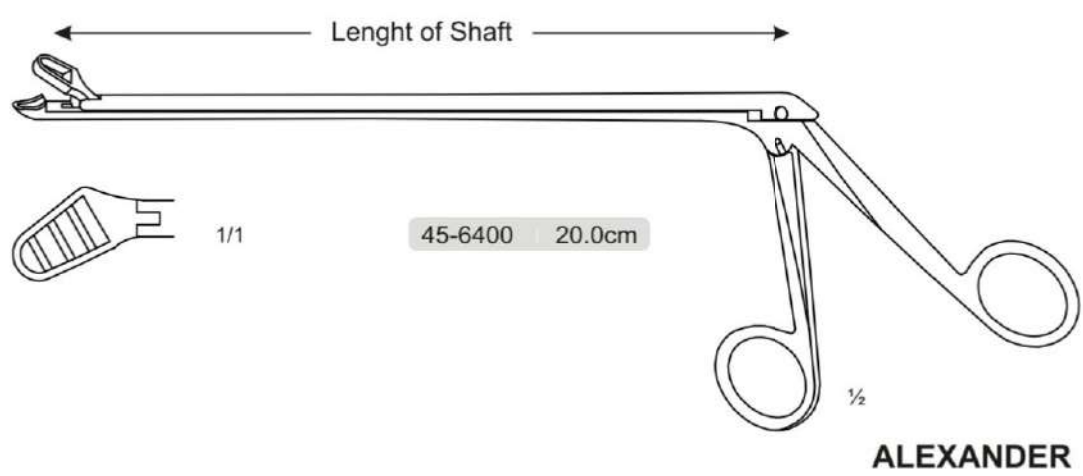
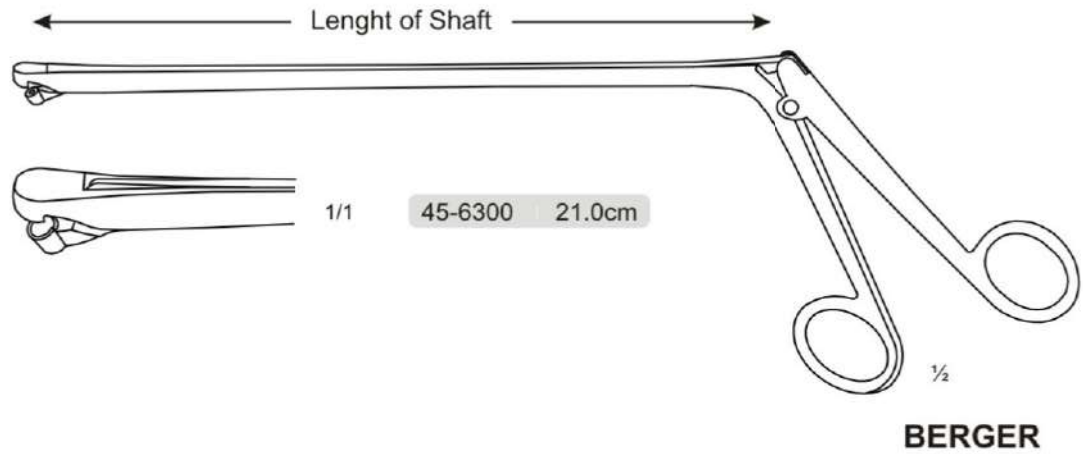

# Cervical Biopsy Forceps

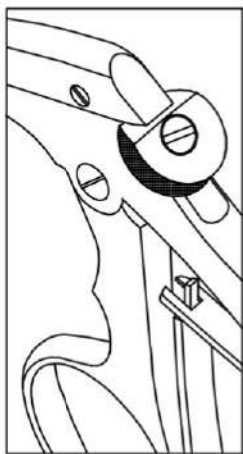
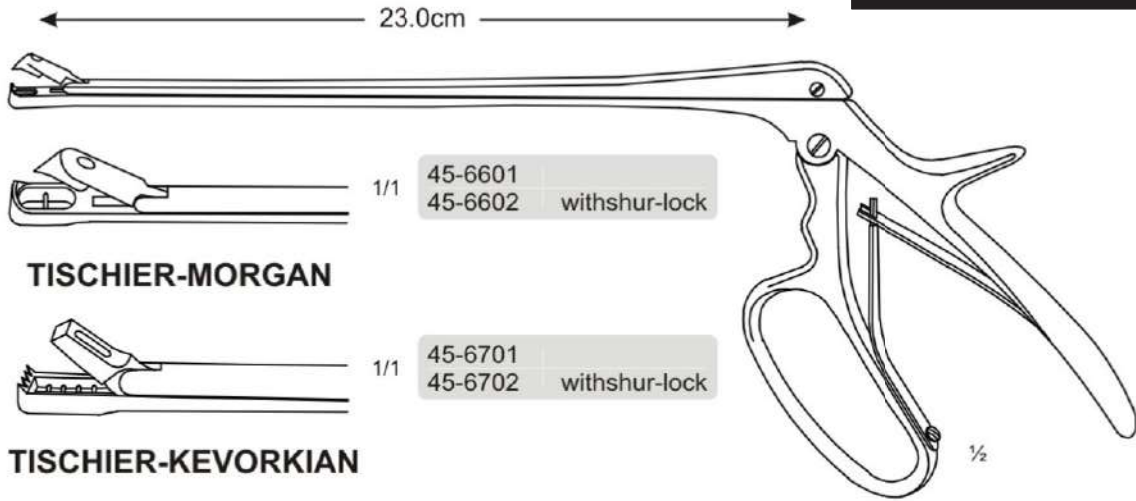

**SHUR-LOCK**

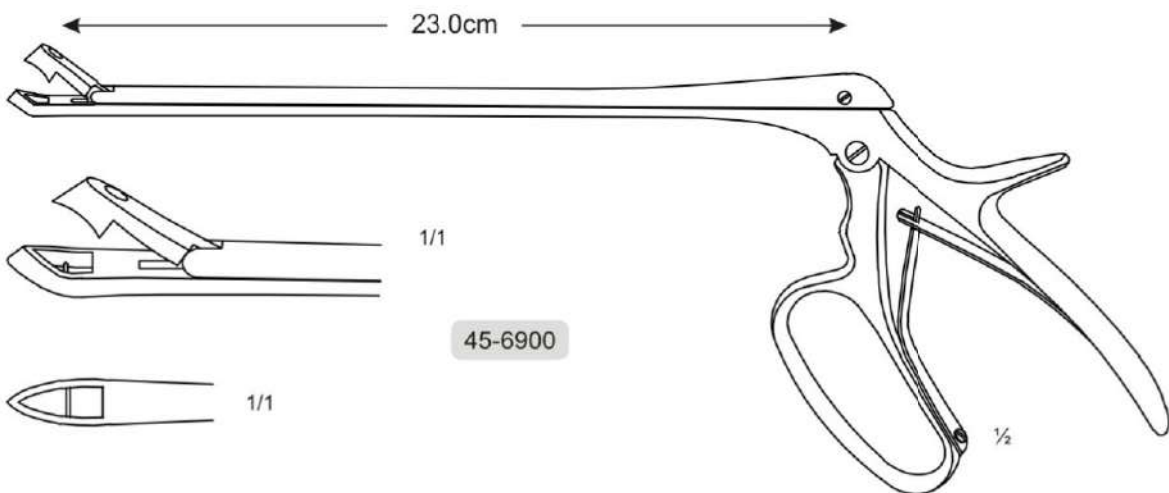
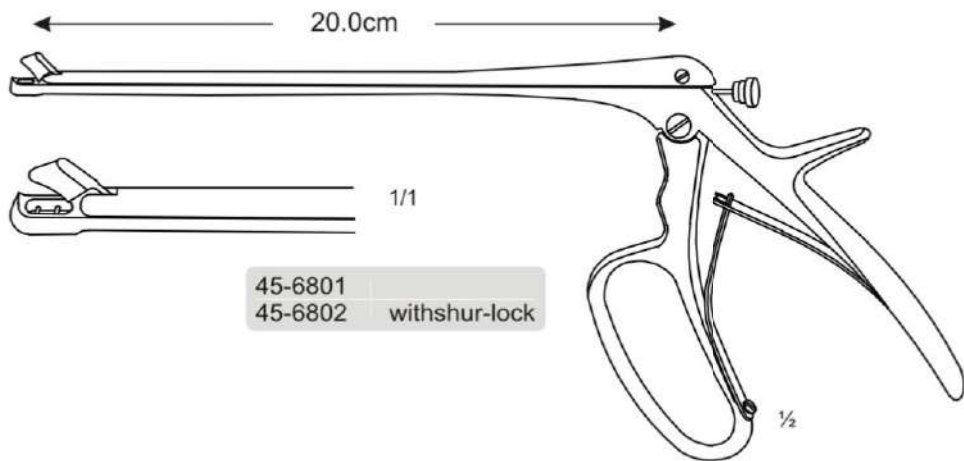



These instruments have a 360° rotation shaft and are interchangeable. The interchangeable types can also be supplied separately.

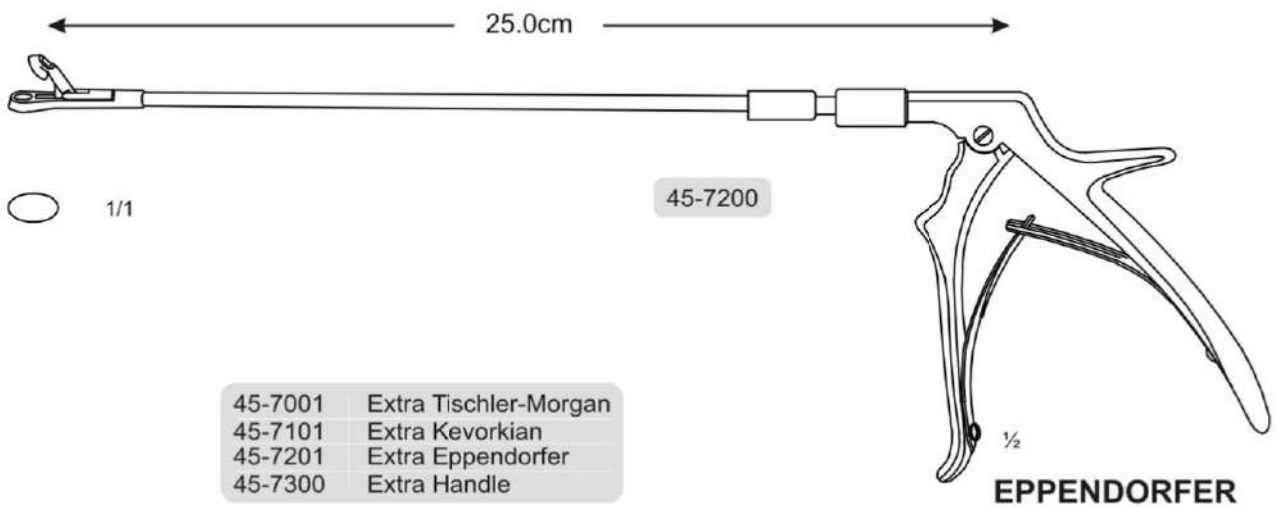
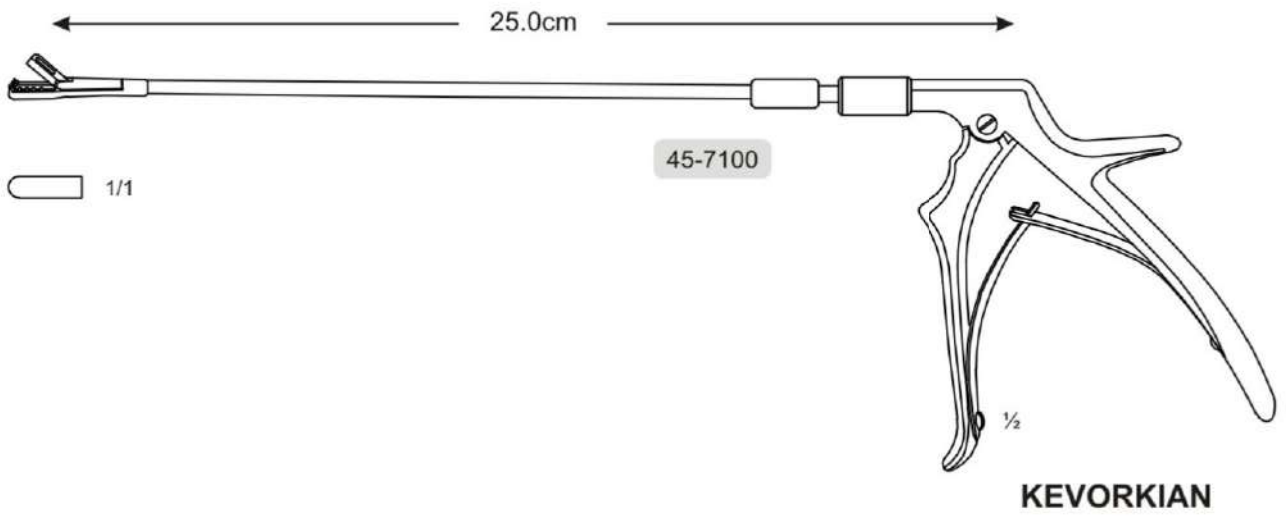
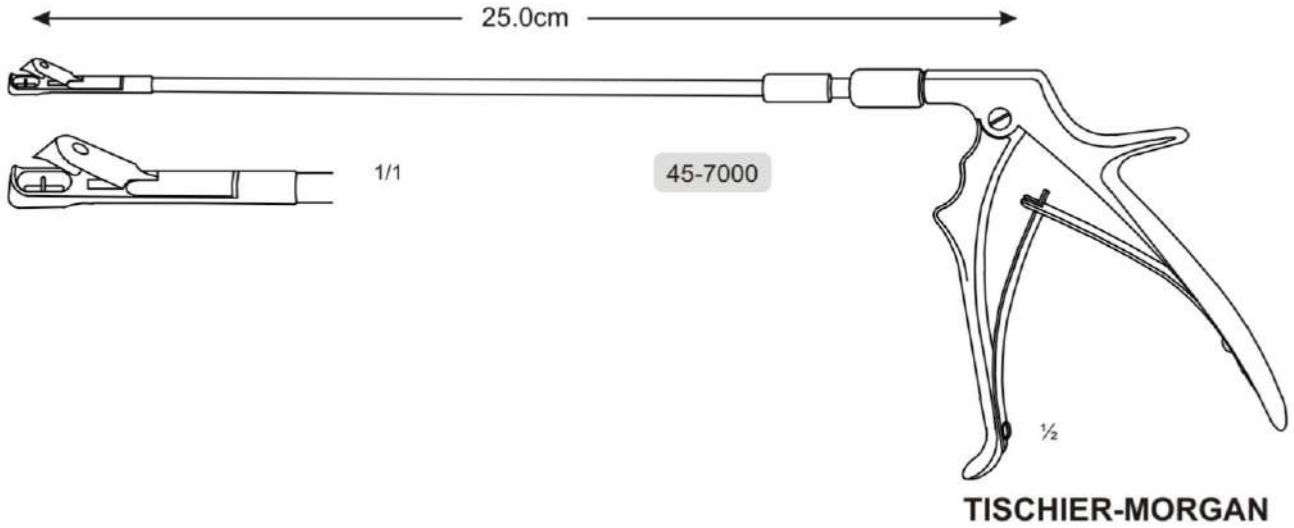

- 45-7001 Extra Tischler-Morgan
- 45-7101 Extra Kevorkian
- 45-7201 Extra Eppendorfer
- 45-7300 Extra Handle

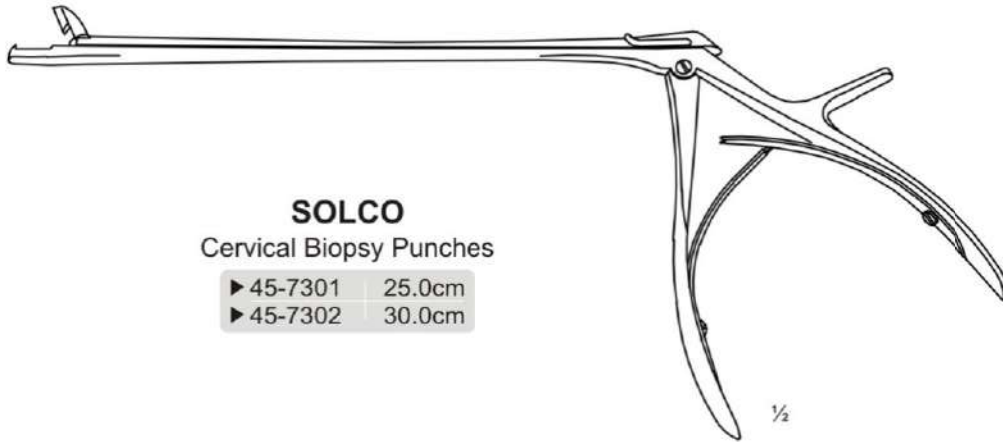

**SOLCO**  
Cervical Biopsy Punches

- ▶ 45-7301 25.0cm
- ▶ 45-7302 30.0cm

1/2

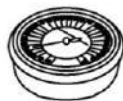
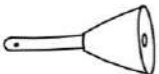
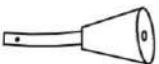
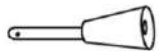
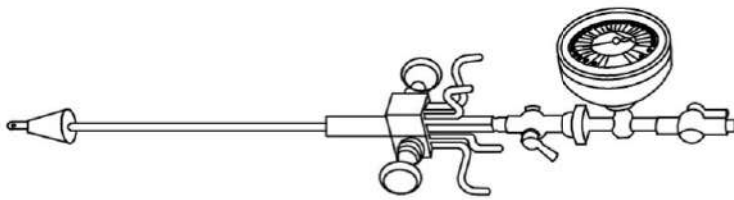

**MANOMETER**

**SALPINGOGRAPHY**  
set

- ▶ 45-7400 Set without Manometer
- ▶ 45-7401 Only Manometer

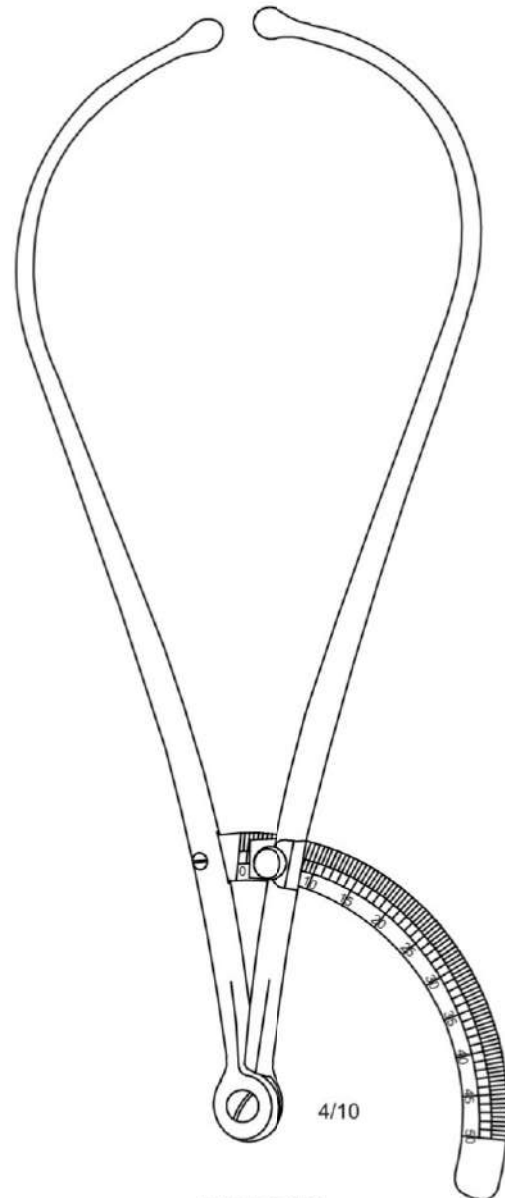

4/10

**MARTIN**

pelvimeter, graduated in centimeters and inches

- ▶ 45-7500 35.0cm



## Alphabetical Index



Bone Cutting Forceps	321-325	Chisels	326-328,332,461
Bone Files	371	<b>CICHERELLI</b> Bone Rongeurs	312
Bone Holding Forceps	299-306	<b>CIRCLE</b> Impactors	339
Bone Hooks	353	Circumcision Clamps	293
Bone Levers	182,349-352	<b>CITEELY</b> Laminectomy Rongeurs	406,441
Bone Mill Set	343	Clamps	
Bone Rongeurs	307-320	Bone	298
<b>BONN</b>		Bulldog	505-508
Iris Forceps	26	Intestinal	153-162
Iris Hooks	224,225	Kidney	289,290
Suture Tying Forceps	25	Tubing	152
<b>BONNEY</b> Tissue Forceps	9	Uterine	541
<b>BOWMAN</b> Eye Probe	432	<b>CLAYMANN-JAFFE</b> Iris Hooks	224
<b>BOZEMANN</b>		<b>CLEVELAND</b>	
Needle Holders	105,121	Bone Cutting Forceps	322
Uterine Forceps	540	Bone Rongeurs	307
Brain Spatula	402,403	<b>COBB</b>	
<b>BRAUN</b> Episiotomy Scissors	44	Spinal Elevators	344
<b>BREISKY</b> Vaginal Speculums	528	Spinal Gouges	335
<b>BROWN</b> Tissue Forceps	11	Cock Screw	340
<b>BRUENINGS</b> Tongue Depressures	270	<b>CODMAN</b>	
<b>BRUNS</b> Curettes	355	Bone Gouges	331
<b>BRUNS OVAL</b> Cup Curettes	360	Bone Osteotomes	331
<b>BUCK</b>		<b>COLIBRI</b> Suture Tying Forceps	25
Ear Curettes	447	<b>COLLIN</b>	
Paracentesis Needles	444	Abdominal Retractors	212
Percussion Hammers	239	Dressing Forceps	261
<b>BURFORD-FINOCITO</b> Rib Spreaders	421	Organ Grasping Forceps, Atraumatic	512
Bulldog Clamps	505-508	Tissue Forceps	157
<b>BUNT</b> Forceps Holders	242	Uterine Elevating Forceps	542
		Vaginal Speculums	526
		Retractors	167
		<b>COLLIN-LOKTITE</b> Retractors	212
		<b>COLVER</b> Tonsil Seizing Forceps	468
		Comedon Extractors	240
		<b>CONVERSE</b>	
		Button end bistouries	456
		Hooks	226
		Needle Holders	100,116
		<b>COOLEY</b>	
		Anastomosis-and Multi Purpose Clamps, Atraumatic	523
		Rib Spreaders	422
		Suction Tubes	265
		<b>CORNEAL</b> Scarifier	433
		<b>CORTICAL</b> Tap Guide	364
		<b>COTTLE</b>	
		Alar Hooks	227
		Nasal Knives	456
		Nasal Rasps	463
		Nasal Scissors	48,60,72,84
		Osteotomes	461
		Raspatories	457,460
		<b>COTTLE-KAZANJIAN</b> Bone Cutting Forceps	321
		<b>COTTLE-KNAPP</b> Scissors	39
		<b>COTTLE-NEIVERT</b> Hook & Knife Guide	227
		Cotton Applicators	273
		<b>CRAFOORD</b> Artery Forceps	142
		<b>CREGO</b> Periosteal Elevators	348
		<b>CRILE</b>	
		Forceps	138
		Retractors	194
		<b>CRILE-WOOD</b> Needle Holders	101,117
		<b>CRUTCHFIELD</b> Skull Traction	375
		Curettes	
		Adenoid	470
<b>C</b>			
Calipers	428		
<b>CALCANEUS</b> Clamps	303		
<b>CANNULA</b> for Abortion	544		
<b>CAPSULOTOMY</b> Micro Scissors	87		
<b>CAROLL</b> Needle Holders	101,117		
<b>CASPAR</b>			
Curettes	357,360		
Laminectomy Rongeurs	416,417		
Laminectomy Retractors	214-218		
Lumbar Speculars	214,215		
Micro Dissectors	390,391		
Nerve Hooks	230		
Retractors	181		
Retractor Blades	214,215,217,218		
Tampers	337		
Vertebral Body Distraction System	219		
Cast Breakers	370		
Spreader	370		
<b>CASTANEDA</b> Anastomosis-and Multi Purpose Clamps, Atraumatic	524		
<b>CASTROVIEJO</b>			
Calipers	428		
Corneal Scissors	88		
Eye Speculums	430		
Needle Holders	107,127,130,131,134		
Razor Blade Holders	113,134		
<b>CASTROVIEJO RYDER</b> Needle Holders	130		
Catheter Introducing Forceps	262		
Catirage Crusher	466		
<b>CHAPUT</b> Artery Tissue Forceps	155		
<b>CHERON</b> Dressing Forceps	261		
<b>CHEVALIER-JACKSON</b> Esophagoscopy Forceps	474,475		



Di		
Dine	354-358,360	
Ear		
Normal	240	
Ear	447,448	
Pier	432	
Surgical	377-379,383,384	
Uterine	357-360	
<b>CUSC</b>		
erine	544-548	
<b>CUSH</b>		
O Vaginal Speculums	526	
<b>A</b>		
<b>HING</b>		
Bridged Hooks	196	
DRAIN Spatulas	402	
Dressing Forceps	5,28	
Drill Burrs	340	
Elyra Hooks	222	
Elevators	348	
Sphincteromy Forceps	415	
Tissinal Retractors	196,197,397	
<b>CUSH</b>		
sue Forceps	5,28	
<b>CUSHING-LANDOLT</b>		
Speculas	376	
<b>ING-VEIN</b> Retractors	197	
<b>D</b>		
<b>DALE</b>		
<b>DANC</b>		
Bone Rongeurs	320	
<b>AN</b>		
Neery Forceps	141	
<b>DAVIR</b>		
ive Hooks	228	
<b>DAVISON</b>		
Retractors	423	
<b>DE B</b>		
Scapula Retractors	195	
<b>KEY</b>		
Bulbta-Clamps	517,519,520,522	
Bulldog Clamps	506	
Dissecting Forceps	511	
Needle Holder	103,119,123	
Retropharyngeal-Vascular Clamps	515,516	
Tag Handle Bulldog Clamps	509	
Tangential Occlusion Clamps	513	
Tissue Forceps	18,23,24,503,504	
<b>DE B</b>		
<b>KEY-BECK</b> Forceps	521	
<b>DE B</b>		
<b>KEY-HESS</b> Bulldog Clamps	505	
<b>DE B</b>		
<b>KEY-MIXTER</b> Forceps	511	
<b>DE B</b>		
<b>KEY-Mesquito</b> Forceps	510	
<b>DE B</b>		
<b>KEY-PEAN</b> Forceps	510	
<b>DE B</b>		
<b>KEY-SATINSKY</b> Forceps	513	
<b>DE M</b>		
<b>ARTEL</b> Gigli Saw Guide	374	
<b>DE VIL</b>		
<b>BISS</b> Cranial Rongeur	375	
<b>DEAN</b>		
Scissors	49,61,73,85	
<b>DEAV</b>		
<b>ER</b>		
Retractors	170,171	
Scissors	35	
<b>DEEP</b>		
Retractors	198	
<b>DEME</b>		
L Bone Wire Guides	361	
<b>DENH</b>		
<b>ARDT</b> Mouth Gags	268	
<b>DENNI</b>		
<b>S-BROWNE</b> Abdominal Retractors	211	
<b>DERF</b>		
Needle Holders	100,116	
Dermat Punches	240	
<b>DERR</b>		
Atrauma Clamps, Atraumatic	523	
<b>D'ERRICO</b>		
Never Root Retractor	185,398	
<b>DESMARRES</b>		
Chalazion Forceps	431	
Lid Retractors	431	
<b>DIEFFENBACH</b>		
Bulldog Clamps	505	
<b>DIETHRICH</b>		
Aorta Clamps, Atraumatic	521	
Dilators, Probes		
Eye	272,432	
Urethral	251,252,272,286,294	
Uterine	533,534	
Vessel	394	
<b>DINGMAN</b>		
Tongue Depressures	269	
Disk Surgery Knives	372	
Set	372	
Dissectors		
Dura	232,395,396	
Ear	446	
Pituitary	372,382,384,390,391	
Suction	466,467	
Tonsil	467	
<b>DIXON-LOVELACE</b>		
Forceps	143	
<b>DONN</b>		
Retractors	196	
<b>DOO'S</b>		
Cord Scissors	45	
Pelvic Suction Tubes	544	
<b>DOUGLAS</b>		
Trocars	264	
<b>DOYEN</b>		
Abdominal Scissors	45	
Intestinal Forceps	158	
Malleis	342	
Myoma Screws	535	
Retractors	187	
Rib Raspatories	423	
Towel Forceps	255	
Vaginal Retractors	530	
Dressing Forceps	2,3,5-8,12,27-31,258-261,440,540	
Drill Burrs	340	
<b>DUCKBILL</b>		
Ear Polypus Forceps	439	
<b>DUNCAN</b>		
Endocervical Curettes	545	
<b>DURA</b>		
Retractors	184,398	
<b>DUVAL</b>		
Tissue Forceps	10,157	
<b>E</b>		
Ear Needles	442-444	
<b>EASTMAN</b>		
Vaginal Retractors	527	
<b>ECHLIN</b>		
Bone Rongeurs	317	
Elevators & Raspatories	199,230,281,292	
	344-348,446,457-460	
<b>EMMETT</b>		
Uterine Tanaculum Hooks	535	
<b>ENDO</b>		
Retractors	199,292	
Endoscopy Forceps	472	
<b>EPISIOTOMY</b>		
Scissors	44,58,70,82	
<b>EPPENDORFER</b>		
Cervical Biopsy and Specimen Forceps	553,556	
Esophagocscopy Forceps	474,475	
<b>EYE</b>		
Scissors	37	
<b>F</b>		
<b>FAHLBUSCH</b>		
Pituitary Curettes	384	
Pituitary Micro Scissors	406	
Pituitary Scoops	384	
<b>FARABEUF</b>		
Bone Holding Forceps	302	
Periosteal Raspatories	346	
Retractors	166	
<b>FARREL</b>		
Cotton Applicators	273	
<b>FAULKNER</b>		
Fine Holding Forceps	26	
<b>FAURE</b>		
Cervical Biopsy and Specimen Forceps	552	
Peritoneum Tonsil Seizing Forceps	469	

# Alphabetical Index



<b>FEIN</b> Cotton Applicators	273	Chisels	461
<b>FERGUSON</b>		D'Septum Knives	456
Scissors	43	Elevators	347,458,459
Bone Holding Forceps	302	Gouges	461
Brain Suction Tubes	404	Skin Hooks	223
Gall Stone Scoops	287	<b>FRIEDMANN</b> Rongeurs	307
Rectal Retractors	248	<b>FRITSCH</b> Retractors	186
Scissors	43	<b>FRYKHOLM</b> Rongeurs	316
<b>FERRIS-SMITH</b> Tissue Forceps	9	<b>G</b>	
<b>FERRIS-SMITH-CUSHING</b> Rongeurs	413	Gallbladder Forceps	288
<b>FERRIS-SMITH-KERRISON</b> Rongeurs	408-411	Gallbladder Scoops	287
<b>FINE</b> Scissors	39,54,66,78	<b>GELLHORN</b> Cervical Biopsy and Specimen Forceps	552
<b>FINOCHIETTO</b>		<b>GELPI</b> Retractors	208,532
Artery Forceps	151,288	<b>GELPI-LOKTITE</b> Retractors	208,532
Needle Holders	104,121	<b>GEMINI-MIXTER</b> Hemostatic Forceps	148
Rib Spreaders	421	<b>GERALD</b>	
<b>FINOCHIETTO-BABY</b> Rib Spreaders	421	Dressing Forceps	7,31
<b>FINOCHIETTO BOZEMANN</b> Needle Holders	105,121	Tissue Forceps	7,31
<b>FISCH</b>		<b>GERZOG</b> Paracentesis Needles	444
Adjustable Mastoid Retractors	207	<b>GESTER</b> Traction Bar for Bone Clamps	298
Ear Dissectors	446	<b>GIERTZ-STILLE</b> Rib Shear	420
Micro Hooks	393	<b>GIGLI</b>	
<b>FLACHMEISSEL</b> Osteotomes	333	Wire Saws	374
<b>FLAT</b> Nose Pliers	365	Wire Saw Handle	374
<b>FOERSTER-BALLENGER</b> Sponge Holding Forceps	256	<b>GILL</b> Iris Forceps	13
<b>FOMON</b>		<b>GILL-CHANDLER</b> Iris Forceps	13
Nasal Hooks	226,227	<b>GILL-HESS</b> Iris Forceps	13
Nasal Rasps	463,464	<b>GILLIES</b> Tissue Forceps	11,30
Nasal Scissors	48,60,72,84	<b>GIL-VERNET</b> Vein Retractor	291
Forceps		<b>GLOVER</b>	
Artery	140-142,144,149,151,155,161,288	Bulldog Clamps	506
Bone Cutting	321-325	Clamps, Atraumatic	523
Bone Holding	299-306	<b>GOLDMANN</b> Angled Scissors	41
Catheter Introducing	262	<b>GOMCO</b> Circumcision Instruments	293
Cervical Biopsy	549-557	<b>GORNEY</b>	
Dressing	2,3,5-8,12,27-31,258-261,440,540	Dissecting Scissors	49,61,73,85
Ear	436,439,441	Suction Dissectors	466
Ear Cutting	438,439	Gouges	326-328,330,331,333,335,461
Gallbladder	288	<b>GRAEFE</b>	
Hemostatic	136-152	Forceps	10
Hysterectomy	144,539	Scarifiers	433
Intestinal	153-162	iris Hooks	225,429
Iris	10-14,26,431	<b>GRAY</b> Dissecting Forceps	290
Kidney Stone	289	<b>GREENBERG</b> Retractor System	403
Micro	18-20	Grid	466
Nasal Cutting	451-453	Grooved Dilators	272
Nasal Dressing	7,440,450	<b>GROSS</b> Sponge & Dressing Forceps	257
Obstetrical	542	<b>GROSS-MAIER</b> Sponge & Dressing Forceps	258
Ovum	543	<b>GRUENWALD</b>	
Rectal Biopsy	248,249	Dressing Forceps	31
Septum Compression	455	Nasal Cutting Forceps	451
Sponge Holding	256-261	<b>GUTGLASS</b> Hemostatic Forceps	539
Sterilizing	241	<b>GUTHRIE</b> Skin Hooks	223,429
Suture Tying	15-17,25	<b>GUYON</b>	
Tenaculum	536-538	Kidney Clamps	290
Tissue	2-12,28-30	Kidney Clamps, Atraumatic	512
Tongue Holding	262	<b>H</b>	
Tonsil	141,468,469	<b>HAEMORRHOIDAL</b> Suction Ligators	250,251
Towel	254,255	<b>HAJEK-KOFLER</b>	
Foreing Body Needle	433	Nasal Cutting Forceps	453
<b>FOX</b> Lupus Curette	240	Rongeurs	407,454
<b>FRAZIER</b>			
Dura Hooks	222		
Suction Tubes	404		
<b>FREER</b>			



<b>HALLE</b> Nasal Scissors	47,59,71,83
<b>HALLE-TIECK</b> Nasal Speculums	449
<b>HALSEY</b> Needle Holders	100,116
<b>HALSTED-MOSQUITO</b> Forceps	136
<b>HALSTED-MOSQUITO(HEISS)</b> Forceps	137
<b>HAMBERG</b> Air Keratomes	433
<b>HANK</b> Uterine Dilators	533
<b>HARDY</b>	
Implant Fork	382
Pituitary Curettes	378
Pituitary Enucleators	382
<b>HARDY-FAHLBUSCH</b> Pituitary Dissectors	382
<b>HARKEN</b> Rib Spreaders	422
<b>HARRINGTON</b> Retractors	174
<b>HARTMANN</b>	
Ear Polypus Forceps	439,441
Nasal Cutting Forceps	451
Nasal Forceps	450
Nasal Speculums	449
Rongeurs	308
<b>HARTMANN-BABY</b> Mosquito Forceps	137
<b>HARTMANN-HOFFMANN</b> Ear Cutting Forceps	439
Ear Forceps	441
<b>HARTMANN-NOYES</b> Polypus Forceps	439
<b>HARTMANN-WULLSTEIN</b> Ear Polypus Forceps	439
Head Traction	375
<b>HEANEY</b>	
Clamps	541
Needle Holders	119
Retractors	182
<b>HEANEY-BALLANTINE</b> Clamps	541
<b>HEANEY-SIMON</b> Vaginal Retractors	528
<b>HEGAR</b>	
Needle Holders	102,118
Uterine Dilators	533
<b>HEGEMANN</b> Scissors	50,62,74,86
<b>HEIFETZ</b>	
Forceps	20
Brain Spatulas	402
<b>HEISTER</b> Mouth Gags	268
<b>HEMINGWAY</b> Bone Curettes	354
<b>HENNIG</b> Plaster Cast Spreaders	370
<b>HERCULASE</b> Wire Cutting Pliers	369
<b>HERRICK</b> Kidney Clamps	290
<b>HEXAGONAL</b> Handle Osteotome	461
<b>HEYMANN</b> Nasal Scissors	48,60,72,84
<b>HEYMANN-KNIGHT</b>	
Nasal Scissors	48,60,72,84
Nasal Polypus Forceps	450
<b>HEYWOOD-SMITH</b> Forceps	539
<b>HIBBS</b> Retractors	182,352
<b>HIRSCHMANN</b> Anoscopes	245
<b>HIRST'S</b> Placenta Uterine Forceps	539
<b>HOHMANN</b> Bone Levers	350,351
<b>HOKE</b> Osteotomes	326
<b>HOLTZHEIMER</b> Self Retaining Retractors	430
Hooks	
Bone	353
Dura	222
Ear	447
Iris	224,225,429
Micro	383~385,393
Nasal	226,227
Skin	223,224
Uterine	535

Vecsel	229,233
<b>HORIZONTAL</b> Retractors	208
<b>HORSLEY</b> Dura Separators	395
<b>HOSOBUCHI</b> Pituitary Fork Spatulas	383
<b>HOUSE-GELFOAM</b> Forceps	153
<b>HOUSE</b>	
Measuring Rods	446
Suction and Irrigation Tubes	405
<b>HOUSE-DIETER</b> Micro Ear Nippers	438
<b>HUBER</b> Biopsy Punch Shanks	473
Handles	473
<b>HUDSON</b>	
Drills	340
Tissue Forceps	4
<b>HUNT</b> Forceps	22
<b>HUNTER</b> Splinter Forceps	11
<b>HURD</b> Tonsil Dissectors	467

**I**

Impactors, Tampers	337~339
<b>INGE</b> Lamina Spreaders	219
Instruments Sterilizing Rack	242
Intestinal Forceps	153~162,472,473,476
<b>IOWA</b> Membrane Puncturing Forceps	540
<b>IOWA-UNIVERSITY</b> Periosteal Elevators	346
<b>IRIS</b>	
Delicate Uterine Tanaculum Hooks	535
Forceps	12
Scissors	37,38,53,65,77
<b>ISRAEL</b> Retractors	190
<b>IVES-FANSLER</b> Anoscopes	246

**J**

<b>JACKSON</b>	
Tissue Seizing Forceps	155
Trachea Tubes	283
Vaginal Speculums	527
<b>JACOBSON</b>	
Vessel Knives	385
Needle Holders	122
Vessel Probe with Ball Stop	394
<b>JAFFE</b> Iris Hooks	224
<b>JAMESON</b>	
Dissecting Scissors	40,55,67,79
Needle Holders	103,121
Strabismus Hooks	225
<b>JANSEN</b>	
Bone Rongeurs	308
Ear Curettes	448
Mouth Gags	268
Nasal Dressing Forceps	7,440
Nasal Tissue Forceps	7
Retractors	200
<b>JENNINGS</b> Mouth Gags	268
<b>JEWELER'S</b> Type Forceps	14
<b>JOHN-HOPKINS</b> Applying Forceps for Bulldog Clamps	505
Bulldog Clamps	505
<b>JONG'S</b> Forceps	465
<b>JOSEPH</b>	
Skin Hooks	224
Nasal Knives	456
Nasal Rasp	463,464



## Alphabetical Index



Raspatories	459	<b>LAMBERT-KAY</b> Atrauma Clamps, Atraumatic	517
J.O.M.W Type Uterine Curettes	548	<b>LAMBOTTE</b>	
JUDD-ALLIS Tissue Seizing Forceps	154	Osteotomes	332
		Raspatories	424
<b>K</b>		<b>LANDOLT</b>	
<b>KALT</b> Needle Holders	113,130	Laminectomy Rongeurs	417
<b>KARIN</b> Curettes	359	Pituitary Curettes	383
<b>KAYE</b> Dissecting Scissors	40	Pituitary Enucleators	383
<b>KELLY</b>		Pituitary Forceps	376
Anoscopes	245	Pituitary Hooks	383
Fistula Scissors	45,58,70,82	Pituitary Scoops	383
Hemostatic Forceps	138	Scalpel Handles for Micro Surgery	237
Retractors	169	Spreader for Specula	376
<b>KERN</b> Bone Holding Forceps	304	<b>LANDOLT-REULEN</b>	
<b>KERRISON</b> Antrum Rongeurs	407,454	Pituitary Curettes	384
<b>KEVORKIAN</b>		Pituitary Dissectors	384
Cervical Biopsy and Specimen Forceps	473,553,556	Pituitary Hooks	384
Endocervical Curettes	545	Pituitary Rasparories	384
Key for Approximators	500	<b>LANE</b>	
<b>KEYES</b> Dermal Punches	240	Bone Holding Forceps	304
<b>KILLIAN</b>		Stomach Clamps	162,163
Nasal Forceps	450	Towel Forceps	255
Nasal Speculums	449	<b>LANGE</b> Nasal Hooks	226
Septum Elevators	347,458	<b>LANGENBECK</b>	
<b>KILNER</b>		Bone Holding Forceps	302
Alar Hooks	226	Retractors	176
Skin Hook	223	Wire Twisters	125
Needle Holders	101,117	<b>LARRY</b> Grooved Probes	252
Plastic Surgery Scissors	40,55,67,79	<b>LARYNGEAL</b> Forceps	476
<b>KIM'S</b> Uterine Clamps	542	<b>LAZAR</b> Micro Suture Tying Forceps	15
<b>KING-HURD</b> Tonsil Dissectors	467	<b>LEES</b> Atrauma Clamps	514
<b>KIRSCHNER</b>		<b>LEE'S</b>	
Abdominal Retractors	211	Dissectors	372
Wire Traction Bows	343	Nerve Retractors	185,372
<b>KLEINERT-KUTZ</b> Rongeurs	313	<b>LEGUEU</b> Bladder Retractors	183,291
Knives		<b>LEKSELL-STILLE</b> Rongeurs	319
Amputation	238	<b>LELAND-JONES</b> Vascular Clamps, Atraumatic	516
Ear	445	<b>LEMPERT</b>	
Lancet Tissue	388	Curettes	357
Meniscotomy	336,462	Rongeurs	310
Nasal	456	<b>LERICHE</b> Forceps	143
Septum	456,457	<b>LEWIN</b> Bone Holding Forceps	305
Tumor Tissue	387,388	<b>LEXER</b>	
Vessel	385,386	Gouges	333
<b>KOCHER</b>		Osteotomes	333
Intestinal Forceps	158	<b>LEYLA</b> Retactor System	399-402
Retractors	178,186	<b>LICHTENBERG</b> Needle Holders	124
<b>KOCHER-DELICATE</b> Forceps	139	Ligators	250,251
<b>KOCHER-LANGENBECK</b> Retractors	177	<b>LISTER</b> Bandage Scissors	47,59,71,83
<b>KOGAN</b> Endo Speculums	531	<b>LISTON</b>	
<b>KOOS</b> Micro Vessel Knives	386	Amputation Knives	238
<b>KRAYENBUHL</b> Nerve Hooks	229	Bone Cutting Forceps	321
<b>KRISTELLER</b> Vaginal Speculums	529	<b>LISTON-KEY</b> Horsley Bone Cutting Forceps	325
<b>KUGLEN</b> Iris Hooks	224	<b>LITTAUER</b>	
<b>KUHNT</b> Corneal Scarifiers	433	Bone Cutting Forceps	321
		Ligature Scissors	46
<b>L</b>		<b>LOCKHART-MUMMERY</b> Grooved Dilator	252
<b>LA FORCE</b> Adenotomes	471	<b>LOCKLIN</b> Scissors	49,61,73,85
<b>LAHEY</b>		<b>LOCKWOOD</b> Tissue Seizing Forceps	155
Gall Duct Clamps	288	<b>LOPEZ-REINKE</b> Suction Elevators	467
Tissue Seizing Forceps	469,538	<b>LORNA</b> Towel Forceps	254
<b>LAMBERT</b> Chalazion Forceps	431	<b>LOVE-KERRISON</b> Rongeurs	412
		<b>LOVE</b> Nerve Root Retractors	184,397
		<b>LOVE-GRUENWALD</b> Laminectomy Forceps	415
		<b>LOVELACE</b> Forceps	152



LOWMAN Bone Clamps	298
LOWMAN-HOGLUND Bone Clamps	298
LOWMAN-LAMBERT Bone Clamps	298
<b>LUCAE</b>	
Hooks	447
Parucentesis Needles	444
LUCAS Bone Curettes	354
LUER Bone Rongeurs	309
LUNIATSCHEK Tonsil Dissectors	467
LW Gauge	428

## M

MAGILL Catheter Introducing Forceps	262
MAGNUM Curettes	360
Mallets	342,466
MARKHARM-MEYERDING Retractors	209
MARTIN Pelvic Meters	557
MARTINI Bone Curettes	354
MARQUARDT Rongeurs	314
MASSING Elevators	460
MASSON Needle Holders	106,122
<b>MATHIEU</b>	
Needle Holders	124
Rectal Speculas	246
Retractors	194
MATSON Raspatories	424
MAYFIELD Rongeurs	314
<b>MAYO</b>	
Common Duct Scoops	286
Gallstone Scoops	287
Scissors	35,52,64,76
Uterine Probes	534
MAYO-BLAKE Gall Duct Clamps	288
MAYO-HEGAR Needle Holders	102,118,119
MAYO-LEXER Scissors	36,53,65,77
MAYO-ROBSON Intestinal Forceps	159
MAYO-RUSSIAN Tissue Forceps	10
MAYO-STILLE Scissors	36,52,64,76
MC DONALDS-SPALECK Lense Implantation Forceps	26
MC GIVNEY Forceps	250
<b>MC INDOE</b>	
Bone Cutting Forceps	323
Dressing Forceps	11,30
Scissors	49,61,73,85
MC KENTY Nasal Raspatories	457
MC GEE Needles	443
MC IVOR Tongue Depressures	269
MEAD Rongeurs	308
<b>MEHDORN</b>	
Applying Forceps for Vessel Clips	502
Vessel Clips	498
MELLINGER Eye Speculums	430
METZENBAUM Scissors	42,56,68,80
METZENBAUM-BABY Scissors	41,56,68,80
METZENBAUM-FINO Scissors	42,43,57,69,81
MEYER Vein Strippers	271
<b>MEYERDING</b>	
Hand Retractors	183,194,198
Self-retaining Retractors	209
MEYHOEFER Eye Curette	432
MICRO Dissectors	382,390,391
MICRO Forceps	18~22
MICRO Hooks	383~385,393
MICRO Needle Holders	107~115,126~134

MICRO Scissors	87~98
MICRO Scoops	383,384,392
MICRO Suture Tying Forceps	15~17
MICRO Vessel Dilators	394
<b>MICRO-ADSON</b>	
Dressing Forceps	3,29
Hemostatic Forceps	145
Tissue Forceps	3,29
MICRO-CASTROVIEJO Needle Holders	108
MICRO-MOSQUITO Forceps	137
MICRO-RYDER Needle Holders	120
MICRO-YASCULAR Needle Holders	123
MIDDELDORPF Retractors	187
MIDDLETON-JANSEN Punch	455
Rongeur	455
MIKULICZ Peritoneum Tonsil Seizing Forceps	469
MILLER Nasal Rasps	464
MILLES Micro Scissors	95
MILLIGAN Dura Dissectors	396
MINI-KEVORKIAN Endocervical Curettes	555
MINI-LANGENBECK Retractors	195
MINI-FRIEDMANN Rongeur Forceps	307
MINI-HOHMANN Bone Levers	349
MINI-LAMBOTTE Osteotomes	332
MINI-TISCHLER Biopsy Punches	555
MISKIMON Retractors	207
<b>MIXTER</b>	
Forceps	146~148
Forceps, Atraumatic	511
MIXTER-O-SHAUGNESSY Artery Forceps	149
MORGAN Anoscopes	246
MORRIS Clamps, Atraumatic	522
<b>MOSQUITO</b>	
Hemostatic Forceps	136,137
Forceps, Atraumatic	510
Mouth Gags	268
MOYNIHAN Hysterectomy Forceps	144
MUHLING Raspatories	345
<b>MULLER</b>	
Approximators	499
Vessel Clips	501
Muscle Elevators	199,292
MUSEUX Tenaculum Forceps	538
MYERS Vein Strippers	272
MYLES Nasal Cutting Forceps	451
Myoma Screw	535

## N

NAGEL Micro Scissors	98
NAGER Tonsil Retractors	467
Nasal Knives	456
NEGUS Gall Duct Clamps	151,288
Needle Holders	100~134
NEIVERT Needle Holders	100,116
Nerve Hooks	228~231,375
NEW-KIM'S Uterine Clamps	542
NEW-ORLEANS Needle Holders	106,122
<b>NICOLA</b>	
Pituitary Curettes	379
Pituitary Micro Scissors	406
Pituitary Raspatories	379
Pituitary Scoop Forceps	406
NOVAC Uterine Curettes	544



## Alphabetical Index



### O

<b>OBWEGESER</b>	
Awls	279
Periosteal Elevators	280,281
Periosteal Osteotomes	282
Retractors	179,181,281
<b>OBWEGESER-RAMUS Retractors</b>	180,281
<b>OCHSNER</b>	
Aorta Clamps, Atraumatic	521
Trocars	264
<b>OCHSNER-KOCHER Artery Forceps</b>	140
<b>O'CONNOR Skin Hooks</b>	223
<b>OEHLER Tissue Forceps</b>	28
<b>OKONEK-YASARGIL Tumor Forks</b>	389
<b>OLDBERG</b>	
Laminectomy Rongeurs	417
Nerve Root Retractors	398
<b>OLSEN-HEGAR Needle Holders</b>	102
<b>ONG-TREUMER Micro Scissors</b>	87
<b>OPERATING Scissors</b>	34,51,63,75
<b>ORAL Retractors</b>	276~279
<b>ORIGINAL-TESSIER Osteotomes</b>	282
O-Rings	250
Osteotomes	282,326~329,331~334,336,461,462
<b>OVERHOLT-MIXTER Forceps</b>	149
<b>OVERHOLT-GIESSENDOERFER Forceps</b>	150
Ovum Forceps	543

### P

<b>PAPAVERO-CASPAR Speculas</b>	376
<b>PAREL Needle Holders</b>	118
<b>PARKER Retractors</b>	166
<b>PARKS Rectal Retractors</b>	247
<b>PAYR Intestinal Crushing Clamps</b>	161
<b>PEAN</b>	
Clamps, Atraumatic	510
Hemostatic Forceps	139
<b>PELVIC Osteotomes</b>	334
<b>PENFIELD Dura Dissectors</b>	395,396
<b>PENNINGTON</b>	
Forceps	151
Periosteal Elevators	459
Percussion Hammers	239
Periosteal Elevators	280,281,345,346,348,459
<b>PICCOLO Cotton Applicators</b>	273
Pin & Wire Stripper	271
Pin Stripper	271
Pin Wheel for Neurological Examination	239
Placenta Uterine Forceps	539
<b>PLESTER Ear Knives</b>	445
<b>Pliers</b>	
Rib Stapple	371
Wire Cutting	367~369
Wire Holding	365,366
<b>POLITZER Paracentesis Needle</b>	444
<b>POOLE Suction Tubes</b>	264
<b>POTTS-SMITH</b>	
Dressing Forceps	6,27
Scissors	50,62,74,86
Tissue Forceps	6
<b>POTTS-YASAGIL Micro Scissors</b>	95
<b>POZZI Tenaculum Forceps</b>	536

### PRATT

Fistula Probes	251
Rectal Speculas	244
Tenaculum Forceps	536
<b>Probes, Dilators</b>	
Eye	272,432
Urethral	251,252,272,286,294
Uterine	533,534
Vessel	394
<b>PROVIDENCE-HOSPITAL Forceps</b>	136
<b>Punches</b>	
Dermal	240
Biopsy	248,249,553~557

### R

<b>RAGNELL Retractors</b>	194,465
<b>RAMPLEY Sponge Holding Forceps</b>	260
<b>RANDALL Kidney Stone Forceps</b>	288
<b>RANEY Clip Forceps</b>	375
<b>Raspatories</b>	345,346,379,380,381,423 424,425,446,457,459,460
Rasps	463,464
<b>RAY Pituitary Curettes</b>	377
<b>RAZOR Blade Holders</b>	113,134
Rectal Biopsy Forceps	248,249
Rectal Specula(Speculum)	244,246
Repositioning Forceps	303,305,306
Retractors	166~219,397~403,430,431,465,467,527~532
<b>RHINO FORCE STAMNBERGER Backward Cutting Forceps</b>	453
<b>RHOTON Micro Suture Tying Forceps</b>	15
Rib Stapple Pliers	371
<b>RIBBON Abdominal Spatulas</b>	172
<b>RICHARDSON Retractors</b>	169
<b>RICHARDSON-EASTMAN Retractors</b>	168
<b>RIGBY Self-Retaining Retractors</b>	532
<b>ROBERTS Artery Forceps</b>	144
<b>ROCHESTER-CARMALT Forceps</b>	140
<b>ROCHESTER-PEAN Forceps</b>	139
<b>ROEDER Towel Forceps</b>	254
<b>ROOT Retractors</b>	185,398
<b>ROSEN</b>	
Ear Curettes	446
Ear Elevators	446
Ear Hooks	446
Ear Knives	445
Ear Raspatories	446
Ear Scoops	446
Needles	442,443
<b>ROSER-KONING Mouth Gags</b>	268
<b>RUBIN</b>	
Rhinoplastic Osteotomes	462
Septum Strening Forceps	455
<b>RUDD Haemorrhoidal Ligators</b>	250
<b>RUMEL Forceps</b>	142
<b>RUSH PIN Impactors</b>	339
<b>RUSKIN Rongeurs</b>	315
<b>RUSKIN-LISTON Bone Cutting Forceps</b>	323
<b>RUSKIN-ROWLAND Cutting Forceps</b>	323
<b>RUSSIAN Tissue Forceps</b>	10
<b>RYDER Needle Holders</b>	103,104,120

### S



<b>SAC</b>		
<b>LFELD</b>	Comedon Extractor	240
<b>SHS</b>		
<b>C</b>	ein Retractors	196
<b>D</b>	ura Hooks	222
<b>SAK</b>	ura Separators	395
Salp	<b>URAI'S</b> Vaginal Speculum	526
<b>SAM</b>	ngograph	557
<b>FII</b>		
<b>K</b>	orceps	21
<b>K</b>	nives for Lancet Tissue	388
<b>SAR</b>	nives for Tumor Tissue	387,388
<b>AOT</b>		
<b>N</b>	rtery Forceps	142
<b>SAT</b>	eedle Holders	106,122
<b>SAUERLEE</b>	Amputation Saws	371
<b>FERBRUCH</b>		
<b>R</b>	etractors	175
<b>S</b>	calforceps	318
<b>SCH</b>	iel Handles	236,237
<b>SCHAEDEL</b>	Towel Forceps	255
<b>SCHINDLER</b>	Peritoneum Forceps	469
<b>SCHMEDEN</b>	Nasal Cutting Forceps	451
<b>SCHNIDT-SAWTELL</b>	Tonsil Forceps	141,468
<b>SCHROEDER</b>	Forceps	536,537
<b>SCHUBERT</b>	Cervical Biopsy Forceps	550
<b>SCHUKNECHT</b>	Ear Knives	445
<b>JMACHER</b>	Cervical Biopsy & Specimen Forceps	
Sciss		549,554
<b>SCOR</b>	s	34-98
<b>HWILLE</b>		
<b>N</b>	ook & Dissectors	232
<b>P</b>	erve Root Retractors	184,397
<b>SCOR</b>	tractor Blades	213
Scree	<b>WILLE-HAVERFIELD</b> Retractor	213
Self	Driver	341
Self	entering Bone Holding Forceps	300
<b>SEM</b>	etaining Retractors 200-219,399-403,429,430,531,532	
<b>B</b>		
<b>P</b>	one Cutting Forceps	325
<b>P</b>	ariosteotomes	425
<b>R</b>	b Holding Forceps	420
<b>SEM</b>	ngeurs	317
<b>KEN</b>		
<b>D</b>	ressing Forceps	5,30
<b>T</b>	ssue Forceps	5,30
<b>SENI</b>	Retractors	193
<b>SENI</b>	ING Needle Holders	106,122
<b>SENI</b>	MILLER Retractors	193
<b>SEXTON</b>	Parucentesis Needles	444
<b>SHEP</b>	ARD iris Hooks	224
<b>SIMPSON</b>	Obstetrical Forceps	542
<b>SIMS</b>		
<b>R</b>	ectal Speculas	244
<b>U</b>	erine Curettes	546-548
<b>U</b>	erine Scissors	36,53,65,77
<b>V</b>	aginal Speculums	527,528
<b>SIMS</b>	MAIER Polypus Forceps	259
<b>SLUC</b>	ER-BALLENGER Tonsillectomes	471
<b>SMIL</b>	LIE Menisotomy Knives	336,462
<b>SMITH</b>	Wire Cutting Scissors	46,58,71,82
<b>SMITH-PETERSEN</b>		
<b>G</b>	ouges	330
<b>O</b>	steotomes	329
<b>R</b>	ongeurs	315
<b>SMITHWICK</b>	Hook & Dissector	232
<b>SOLCO</b>	Biopsy punches	557
<b>SOLCO</b>	Pooler Suction Tube	264
<b>SPALECK MICROMA</b>	Lense Implantation Forceps	26
Spatulas		172,173,189,383,402,403
<b>SPENCER</b>	Ligature Scissors	46
Speculums, Speculas		
<b>E</b>	ar	448
<b>E</b>	ndocervical	531
<b>E</b>	ye	430
<b>L</b>	aminectomy	214,215,376
<b>N</b>	asal	449
<b>R</b>	ectal	244,246
<b>V</b>	aginal	526
<b>SPINAL</b>	Curettes	357-360
<b>SPURLING</b>	Laminectomy Forceps	415
<b>ST.MARKS</b>	Pelvic Retractor	188,189
Stainless Rulers		428
<b>STAUDE-MOORE</b>	Tenaculum Forceps	538
<b>STELLBRINK</b>	Bone Rongeurs	308
<b>STERILIZING</b>	Forceps	241
<b>STEVENS</b>	Tenotomy Scissors	38,54,66,78
<b>STILLE</b>		
<b>C</b>	hiseles	328
<b>G</b>	ouges	328
<b>O</b>	steotomes	328
<b>R</b>	ongeurs	317
<b>STILLE-LISTON</b>	Bone Cutting Forceps	324
<b>STILLE-LUER</b>	Rongeurs	316,318
<b>STILLE-RUSKIN</b>	Rongeurs	316
<b>STRABISMUS</b>	Scissors	40,55,67,79
<b>STRANDELL-STILLE</b>	Tendon Hook & Retractors	195
<b>STRATTE</b>	Needle Holders	105,122
<b>STRUMPEL</b>	Ear Polypus Forceps	439
<b>STRUYCKEN</b>	Nasal Cutting Forceps	451,453
Stylets		294
Suction and Irrigation Tips		405
Suction Dissectors		466
Suction Tubes(Tips)		264,265,404,405,544
<b>SUMIKOSHI'S</b>	Rectal Retractors	247
<b>SYPERT</b>		
<b>B</b>	one Rongeurs	320
<b>T</b>	ampers	339
<b>T</b>		
T-Handle used with Endo Retractors		199,292
<b>TABB</b>	Ear Knives	445
<b>TAKAHASHI</b>	Nasal Cutting Forceps	414,453
Tampers, Impactors		337-339
<b>TAYLOR</b>		
<b>D</b>	ressing Forceps	6
<b>P</b>	ercussion Hammer	239
<b>R</b>	etractors	182,352,372
<b>R</b>	etractor Blades	213
<b>T</b>	issue Forceps	6
<b>THOMS-ALLIS</b>	Tissue Forceps	154
<b>THYROID</b>	Lift	476
<b>TISCHLER</b>	Biopsy Punches	473,555,549
<b>TISCHLER-MORGAN</b>	Biopsy Punches	555,556
<b>TISCHLER-KEVOKIAN</b>	Biopsy Punches	555
Tissue Forceps		2-12,28-30
<b>TIVNEN</b>	Tonsil Forceps	468
<b>TOENNIS</b>	Dura Hooks	222
<b>TOENNIS-ADSON</b>	Scissors	41,55,67,79
<b>TOHOKU</b>	Towel Forceps	255
Tongue Depressures		270
Tongue Holding Forceps		262
Tourniquets		233



